

Pentamix™ Lite

Automatic Mixing Unit



Technical Data Sheet

Pentamix™ Lite Automatic Mixing Unit – from the inventor of automatic mixing

20
YEARS
PENTAMIX

Since the introduction of the first impression materials decades ago, 3M ESPE has constantly improved and expanded its impressing portfolio. Today, it offers a variety of high-performance vinyl polysiloxane (VPS) and polyether impression materials, fast and easy-to-use mixing devices, and other impression-related products and accessories, as well as a digital impression solution. Numerous awards from trade publications and positive customer feedback agree: All 3M ESPE products are designed to make reliably accurate impressions for great-fitting final restorations, helping dental professionals to optimize and fully control their impression procedures.

In 1993 a veritable revolution took place: 3M ESPE introduced the first automatic mixing unit for impression materials – Pentamix™. Since then, a growing community of dentists all over the world is taking advantage of the benefits of automatic mixing using the Pentamix™ System.

The **NEW** Pentamix Lite mixing unit now completes the range of automatic mixing devices by adding an affordable but powerful model. Automix for every dental practice – **AUTOMIX FOR ALL!**

3M ESPE's unique line of innovations in automatic mixing

CURRENT PENTAMIX™ SYSTEMS:



Handmix



Jars/tubes



Garant™ Dispenser

1983



Pentamix™
Automatic Mixing Unit

1993



Pentamix™ 2
Automatic Mixing Unit

1999



PENTAMIX™ 3
FASTEST AND SMALLEST
DEVICE AVAILABLE!

Pentamix™ 3
Automatic Mixing Unit

2008



NEW ENTRY MODEL!
PENTAMIX™
LITE
PORTABLE, LIGHTEST
DEVICE AVAILABLE!

Pentamix™ Lite
Automatic Mixing Unit

2014



Add **unique** product features to the benefits of automatic mixing

The newcomer, Pentamix™ Lite Automatic Mixing Unit, is the entry model to the world of automatic mixing – with a convenient mixing speed that is perfectly suited for beginners or dental practices that make numerous impressions every day.

The Pentamix Lite mixing unit is designed to work with all 3M ESPE Penta™ Impression Materials – from high-viscosity putty to medium-bodied materials – and consistently delivers a homogeneous, reproducible mixing quality for void-free impressions.

The mixing unit set-up is fast and intuitive: Just plug in, push the start button, and start mixing!

With its unique swivelling design, the Pentamix Lite mixing unit also helps to save valuable counter space – changing from the upright standby to the rotated working position requires just one easy movement. Thanks to its light weight and an ergonomic handgrip, it can easily be carried from one operator to another – if desired.

COMPACT design

Saves valuable space in the upright standby position.



EASY to get started

Fast and intuitive set-up – just swivel in the working position.



CONVENIENT AND CLEAN operation

Press the green start button and start filling the tray or syringe directly from the device.



PORTABLE design

Easy to carry from operator to operator thanks to light weight and integrated handgrip.



Penta™ Mixing Tip – Red **for all** Pentamix™ Devices

- Enhanced geometry to facilitate insertion in all Pentamix devices
- Grey cover plate for increased insertion visibility
- New authentication label on packaging — ensures that you are using the original



Automatic mixing – fast, precise and convenient

Dental professionals increasingly prefer automixing of impression materials using an automix device such as the Pentamix™ System over hand- or even gun-mixing. When it comes to accuracy of impressions and final restorations, simplified work procedures and higher productivity, using an automatic mixing unit offers significant clinical and practice management advantages:

- **HOMOGENEOUS AND VOID-FREE MIXING RESULTS** of reproducible quality (Fig. 1)
- **FAST, TIME-SAVING** procedure and push-button activation
- **ECONOMICAL** and exact dispensing of the amount of material needed
- **HYGIENIC** direct filling of tray and syringe without the risk of cross-contamination
- **MORE EFFICIENT WORKFLOW** for higher productivity
- **FULL CONTROL** of your procedure together with 3M ESPE impression materials

Compared to gun-mixing, using an automatic mixing device means less hand fatigue plus higher productivity due to a higher volume in Penta™ Foil Bags, resulting in fewer cartridge changes (one pair of Penta foil bags can last for up to 12 full arch impressions).

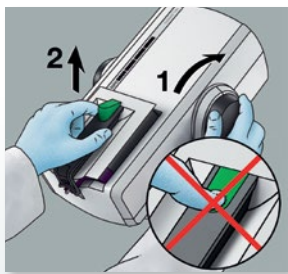

Fig. 1: Hand-mixed putty (left) compared to an automatically mixed putty material out of the Pentamix™ System from 3M ESPE (right). The automatically mixed impression material is homogeneously mixed and does not show any voids.

	AUTOMATIC MIXING with the Pentamix™ Lite 0:40 MIN.	HAND-MIXING using a standard hand-mix putty 2:30 MIN.	AUTOMATIC MIXING using a gun dispenser 0:40 – 1:00* MIN.
PREPARATION & DOSING	<p>TIME SAVING OF 25%!</p> <p>No dosing required</p>		<p>Preparation steps, no dosing required</p>
MIXING	<p>No mixing required</p>		<p>Mixing requires tedious hand pumping</p> <p>Mixing speed may vary (depending on the consistency of the tray material and the skill of the assistant)</p>
TRAY FILLING			

* More time is needed when two partially filled cartridges have to be combined to fill one tray.

Fast and intuitive set-up and use



1. Remove the cartridge.

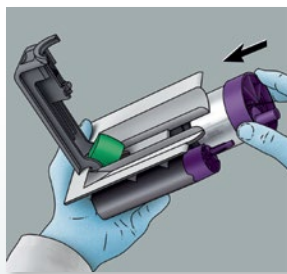

2. Insert Penta™ Foil Bag with the 3M ESPE impression material of your choice into the cartridge.

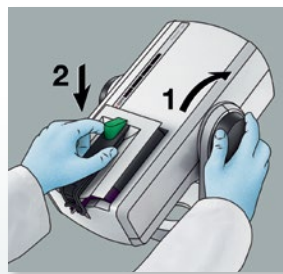

3. Insert the cartridge into the Pentamix™ Lite Automatic Mixing Unit.



4. Turn the wheel (piston) forward.

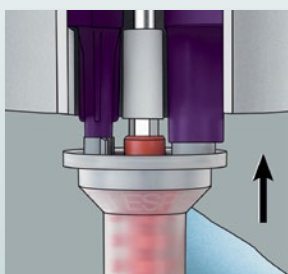

5. Attach a Penta™ Mixing Tip – Red.



6. Close the latch with an audible click.



7. Press the green start button to fill the impression tray or elastomer syringe.

Space-saving, compact design

With its unique swivelling design, the Pentamix Lite mixing unit can be moved into the upright standby position (Fig. 2) if not in use, so that it requires only minimal counter space and can be stowed in a small space. In this position it requires less than half the space of other automatic mixing devices (and only two-thirds of the space compared to the Pentamix 3 unit) (Fig. 5). When needed, it can be swivelled down into the working position with just one easy movement (Figs. 3, 4).



Fig. 2: Upright standby position

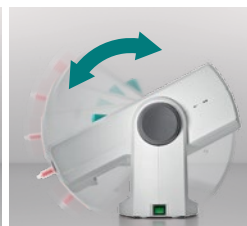

Fig. 3: Swivel mechanism



Fig. 4: Working position







	Footprint in sq. in. (cm ²)
 Pentamix™ Lite Automatic Mixing Unit (3M ESPE)	52 (333)
 Pentamix™ 3 Automatic Mixing Unit (3M ESPE)	82 (528)
 Pentamix™ 2 Automatic Mixing Unit (3M ESPE)	110 (708)
 MixStar-eMotion (DMG)	112 (725)
 Modulmix (Zhermack)	112 (783)
 Duomix™/Duomix™ II; Dynamix®/Dynamix® speed (manufactured by Renfert)	106 (682)

Fig. 5: Space requirement of the Pentamix™ Lite Automatic Mixing Unit from 3M ESPE in standby position compared to competitive automatic mixing devices and other Pentamix™ Systems.

Source: 3M ESPE internal data. Data available on request from 3M ESPE. See contact information, back page.

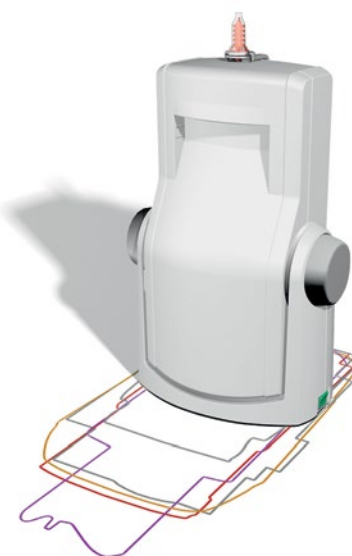

Unique handgrip and light weight

With an integrated ergonomic handgrip on the rear of the device (Fig. 6) and a reduced weight of only 14.8 lbs. (6.7 kg) (Fig. 7) the Pentamix™ Lite Automatic Mixing Unit is easy to carry from one operator to another when desired or store away when not in use. It is therefore the ideal solution for practices with multiple operatories.



Fig. 6: Integrated handgrip on the rear of the device.

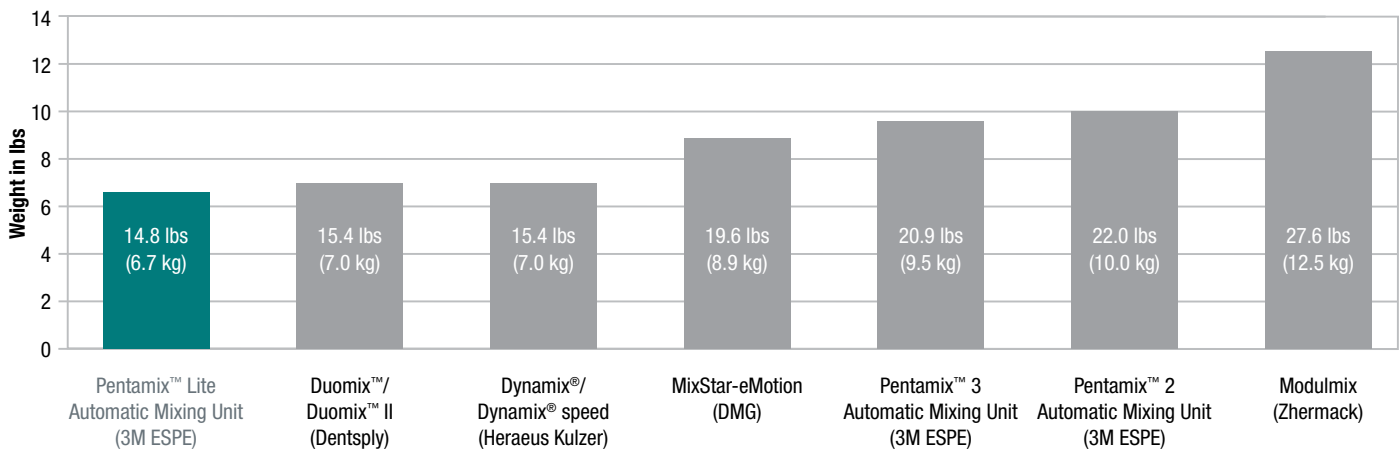

Fig. 7: Weight of the Pentamix™ Lite Automatic Mixing Unit compared to competitive devices and other Pentamix™ Systems. Source: 3M ESPE internal data. Data available on request from 3M ESPE. See contact information, back page.

Faster tray filling

Like its predecessors, the Pentamix Lite mixing unit helps you save valuable time compared to hand-mixing. The device's mixing speed lets you fill even very large trays with heavy body, medium body and high consistency putty materials in only 30 seconds. Smaller trays can be filled even faster (Fig. 8). This mixing speed is well suited for beginners in automatic mixing as well as practices with many impressions per day.

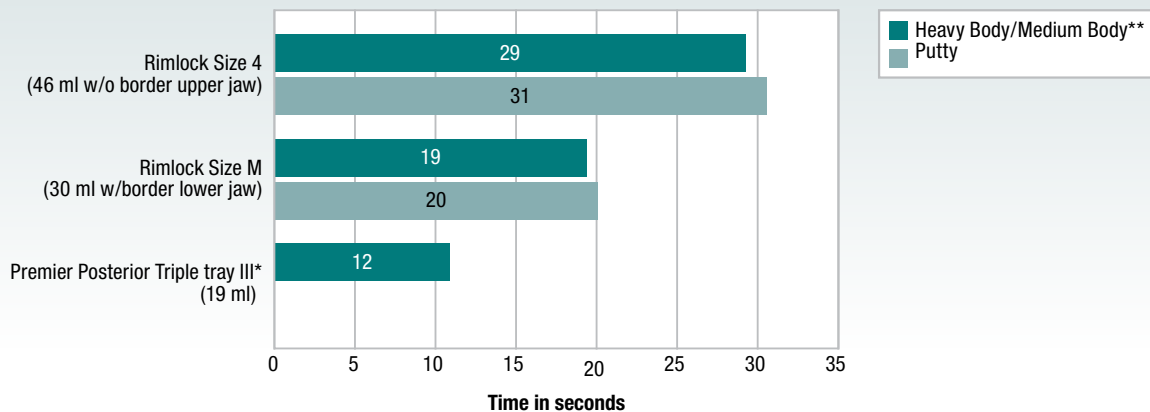

Fig. 8: Required time (in seconds) to fill different tray types from the Pentamix™ Lite Automatic Mixing Unit with either a heavy body or putty impression material. *Dual-arch trays are not recommended for putty materials. ** Mixing speed for lower viscosity materials is the same as for heavy body materials.

Excellent results from the application test

To test how customers perceive the new Pentamix™ Lite Automatic Mixing Unit, 3M ESPE conducted a test with 32 randomly chosen dentists (making over 630 impressions) from the U.S., India, France, Poland, and the U.K., who are currently not using an automatic mixing device. **Testers especially valued the easy handling (Fig. 9), the better quality of the final impressions due to homogeneously mixed, void-free impression materials (Fig. 10) and the time savings (Fig. 11).**

Over 90% of the testers are very satisfied or satisfied with the easy handling of the Pentamix™ Lite Automatic Mixing Unit.

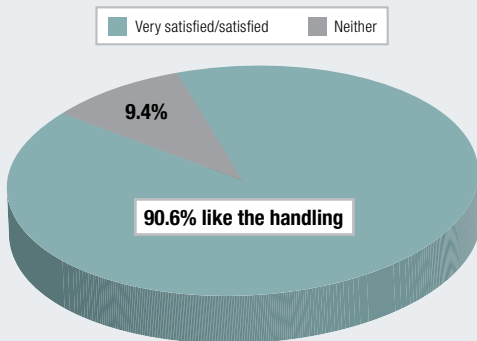

Fig. 9: Satisfaction with the handling of the Pentamix™ Lite Automatic Mixing Unit, n=32.
Source: Prototype testing conducted by 3M ESPE.

More than 90% are very satisfied or satisfied with the mixing quality from the Pentamix™ Lite Automatic Mixing Unit.

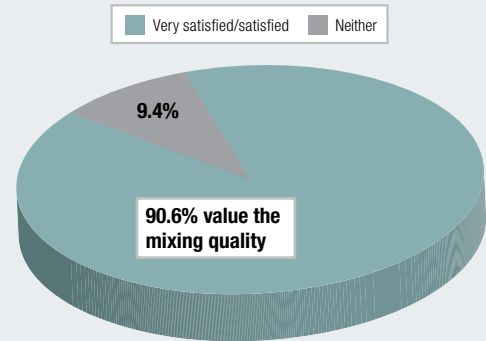

Fig. 10: Satisfaction with the mixing quality of the impression material from the Pentamix™ Lite Automatic Mixing Unit, n=32.
Source: Prototype testing conducted by 3M ESPE.

Almost 72% of the testers think that impression-taking with the Pentamix™ Lite Automatic Mixing Unit saves time compared to the mixing method currently used.

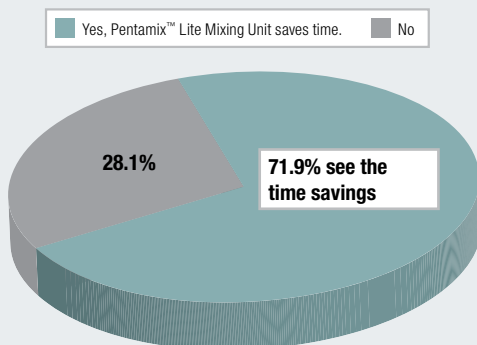

Fig. 11: Time savings when using the Pentamix™ Lite Automatic Mixing Unit, n=32.
Source: Prototype testing conducted by 3M ESPE.

78% would recommend the Pentamix™ Lite Automatic Mixing Unit to their colleagues.

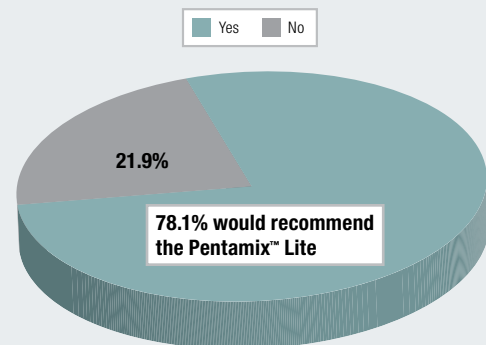

Fig. 12: Recommendation rate for the Pentamix™ Lite Automatic Mixing Unit, n=32.
Source: Prototype testing conducted by 3M ESPE.

When asked “How would you describe the new Pentamix Lite mixing unit” to your colleagues, dentists from all around the world stated:

“Nice design, very smooth and constant mix” Dr. Richard Rappa, USA
“Convenient, operator friendly, less material wasted” Dr. Marileth Coria, USA
“Awesome” Dr. Kirpa Johar, India
“Good impressions with easy mixing and saving lot of time and repetitions” Dr. Jawahar, India
“Device is easy to handle, alone or if you are two, quickly and cleanly several impression materials” Dr. Mercier, France

“Automatic mixing machine allowing the use of Impregum™” Dr. Benjamin Boubil, France
“Perfect device for reproducible high quality mixed material, easy to use, saving time aesthetically pleasing”
 Dr. Kamil Szymański, Poland
“Better efficiency in the prosthetic treatment”
 Dr. Andrzej Minkowski, Poland
“Impressions have never been so easy and so accurate!” Dr. Bilal Sheikh, Great Britain

Technical Data

Operating mode:	Short-term operation – max. 1.5 min. on, min. 10 min. off
Cartridges:	Suitable for use with Penta™ foil bags Dimensions: 60 × 130 mm, 26.8 × 130 mm
Housing:	All parts of the housing are made of impact-resistant plastic
Power supply:	115 V/230 V (see rating plate)
Frequency:	60 Hz/50 Hz (see rating plate)
Power input:	2.5 A/1.5 A
Ambient temperatures:	18° C/64° F 40° C/104° F
Rel. humidity:	20% 80%
Classification:	Hazard Class I
Dimensions:	Working position: L 396 mm × W 265 mm × H 305 mm Standby position: L 165 mm × W 265 mm × H 406 mm
Weight:	approx. 6.7 kg (14.8 lbs)
Storage and transport:	-20° C to +60° C / -4° F to 140° F, Maximum rel. humidity 80%
Emission sound pressure level:	approx. 65 dB(A)

References

"Ask Dr. Christensen", Gordon J. Christensen, Dental Economics, April 2002.

"Assessment of preference of mixing techniques and duration of mixing and tray loading for two viscosities of vinyl polysiloxane material", J. Nam, A.J. Raigrosdki, J. Townsend, X. Lepe, L.A. Mancl, J Prosth Dent (2007), 12 – 17, School of Dentistry, University of Washington, Seattle, WA.

"Productivity counts", M. Firla, W. Bergin, DPR Europe, (2007), 43 – 44.

"Properties of elastomeric impression materials using automix technique", M. Wildenhain, P. Pospiech, P. Rammelsberg, W. Gernet, (1998) IADR #1062, Department of Prosthodontics, University of Munich, Germany.

3M ESPE Clinical Survey with U.S. Dental Practitioners (2006), internal data, 3M Deutschland GmbH, Location Seefeld, Germany.

"Assessment of Preference of Mixing Techniques for Impression Materials", C.E. Sabrosa¹, L. Vasconcelos¹, L.M. Miragaya², and L. Alves¹,
¹Universidade do Estado do Rio de Janeiro, Rio de Janeiro, Brazil, ²Universidade Federal Fluminense, Rio de Janeiro, Brazil, AADR 2011, #1974.

"Attitude of Graduate Students on Mixing Techniques for Impression Materials", G. Ribeiro¹, L. Vasconcelos¹, L. Miragaya², S.M. Morgano³ and C.E. Sabrosa¹,
¹Universidade do Estado do Rio de Janeiro, Rio de Janeiro, Brazil, ²UFF, Rio de Janeiro, Brazil, ³Boston University, Boston, MA Brazil, AADR 2012, #433.

"Attitude of Professors on Mixing Techniques for Impression Materials", L. Vasconcelos¹, B. Sartori¹, S.M. Morgano² and C.E. Sabrosa¹,
¹Universidade do Estado do Rio de Janeiro, Rio de Janeiro, Brazil, ²Boston, University, Boston, MA, AADR 2012, #434.

Customer Care Center: 1-800-634-2249
www.3MESPE.com/PentamixLite

3M ESPE

Dental Products

2510 Conway Avenue
St. Paul, MN 55144-1000 USA
1-800-634-2249

3M Canada

Post Office Box 5757
London, Ontario N6A 4T1
Canada
1-888-363-3685

3M, ESPE, Impregum, Imprint, Penta and Pentamix are trademarks of 3M or 3M Deutschland GmbH. Used under license in Canada. © 3M 2014.
All rights reserved. Please recycle. Printed in U.S.A. 70-2013-0605-0