

PROSERIES LUXURY VINYL FLOORING

TRIM INSTALLATION & CARE GUIDE

STOCKING AND SPECIAL ORDER

Daltile | Dal-Tile, LLC
7834 C.F. Hawn Freeway
Dallas, TX 75217

TECHNICAL SERVICES
1.800.933.TILE



TABLE OF CONTENTS

3	ProSeries™ Extra Tall Stair Nose
9	ProSeries™ Vinyl Stair Cap
13	ProSeries™ Slim Trim 4-in-1 Transition
18	ProSeries™ Full Round Stair Tread
21	ProSeries™ Round Stair Nose
27	ProSeries™ Quarter Round
31	ProSeries™ Slim Cap

EXTRA TALL STAIR NOSE

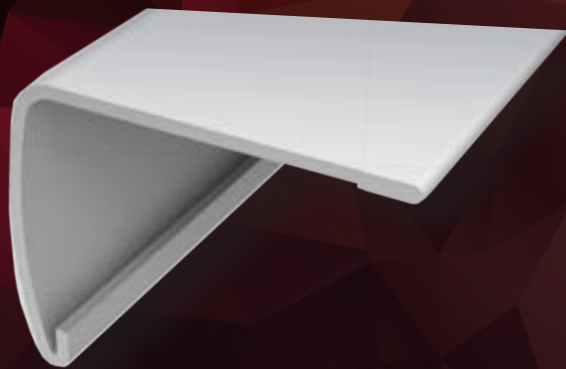

Creates a transition to the edge of the step by overlapping the flooring on the back end. Can also be installed flush on floors with an overall thickness up to 4 mm.*

* References to flooring thickness refer to the total thickness of all members of the floor installation being laid upon the subfloor. This typically is comprised of the flooring plank, e.g. Vinyl or Laminate, the underlayment, either attached or loose lay and any additional vapor barriers.

Extra Tall Stair Nose - EXTSN

Note: Available for both Rigid Click and Flexible Glue Down Platforms.

Technical Information — Sizes

Extra Tall Stair Nose

The Extra Tall Stair Nose combines style and function to enhance the beauty of a staircase or step. For use on flooring with an overall thickness of up to 19 mm (0.75").

Surface Material: High Wear Resistant Aluminum Oxide Laminate

Core Material: Aluminum

Shim

To be used with Extra Tall Stair Nose for floors for flush installations

(See illustrations at bottom right).

Material: Standard MDF/HDF

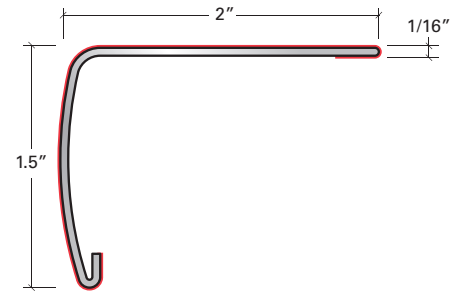

Installation*

Overlap Install

Locked Down Install

Used where floating of the floor is not required, as with Stair Tread or Glued-Down/Nailed-Down floors. This can be used on floating floors where expansion and contraction will occur on the opposite side of the flooring plane.

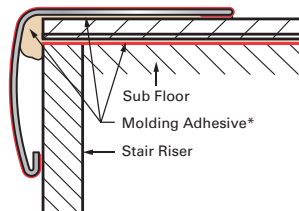

Floating Install

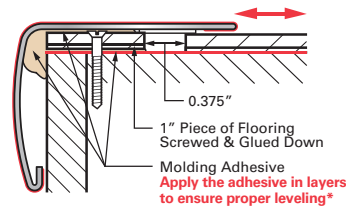

Flush Install

Locked Down Install

Used where floating of the floor is not required, as with Stair Tread or Glued-Down/Nailed-Down floors. This can be used on floating floors where expansion and contraction will occur on the opposite side of the flooring plane.

Tongue side of plank **MUST** face the Extra Tall Stair Nose, Shims, and flooring planks must be glued down to subfloor.

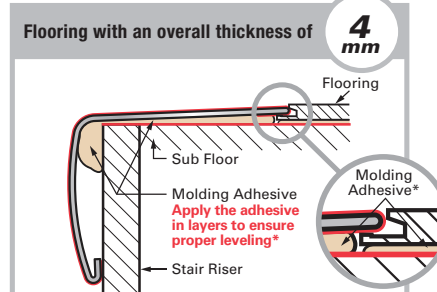
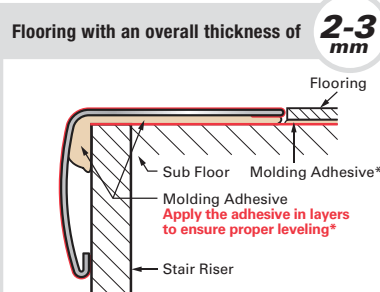

Extra Tall Stair Nose - EXTSN

Installation on flooring with an overall thickness of up to 19 mm (0.75").

"LOCK-DOWN" INSTALLATION

Flooring with an overall thickness of up to 19 mm (0.75")

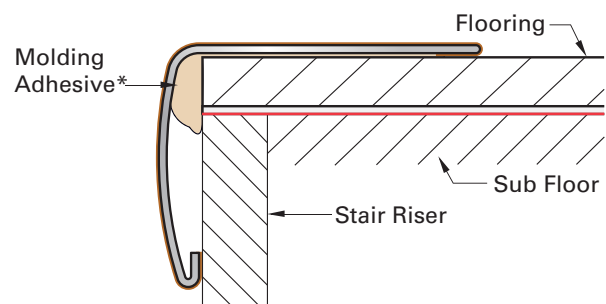
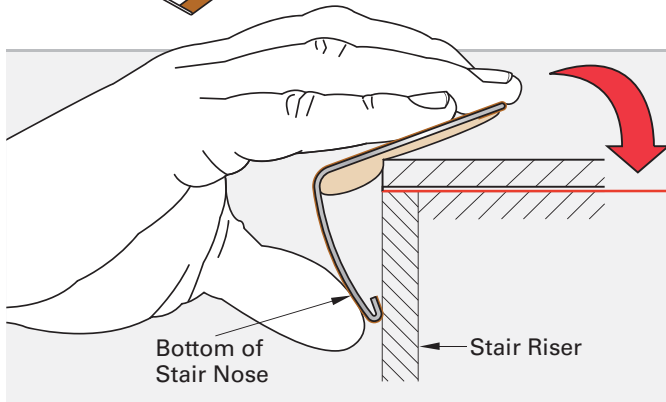
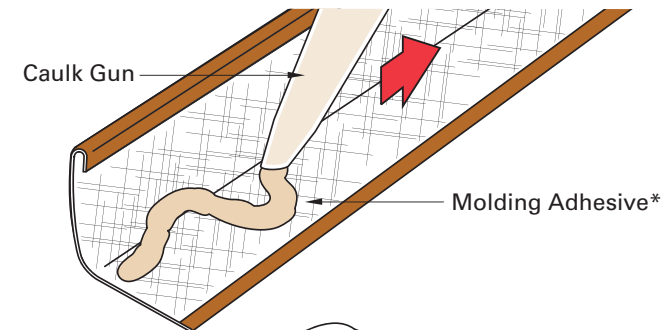
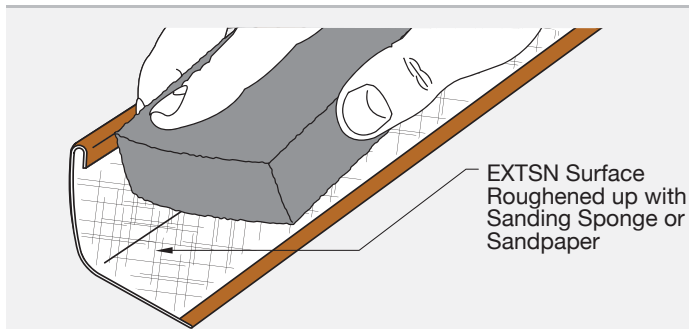
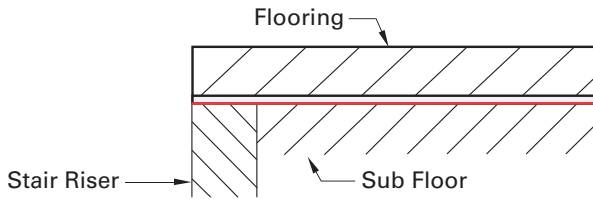

Step 1

Install the riser flush to the stair. Glue down flooring planks (for more details see manufacturers recommendations). Then, clean flooring and molding as directed below:

CLEANING PREPARATION FOR BOTH SURFACES

Preparing the floor & molding as outlined is mandatory to achieve the required bonding strength

1. Use a damp cloth (water only) to clean both surfaces of loose particles or surface films.
2. Roughen the surfaces with sandpaper (100-150 grit), sanding sponge or metal brush. For flooring, only roughen up area that will be covered (1.25" to 1.5").
3. Degrease both surfaces to remove all traces of oil, grease, dust, and fingerprints by using a solvent such as methyl ethyl ketone (MEK), acetone or isopropyl alcohol.
4. Let both surfaces dry thoroughly before applying Molding Adhesive.

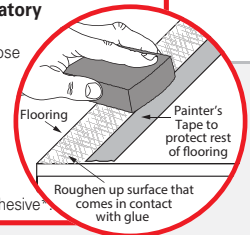

Step 2

Turn EXTSN over and roughen the inside surface of the EXTSN to increase bond by means of 60 grit sandpaper, sanding sponge, or a metal brush.

Step 3

Next, apply a generous bead of a Molding Adhesive* along the entire inside corner.

Underside of molding generously covered with Molding Adhesive*

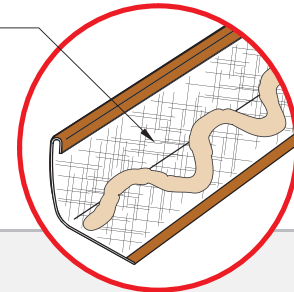

Step 4

Touch the bottom of molding to the stair riser and carefully roll the stair nose in place. Make any final adjustments before you push the molding all the way down. Once it's in the final position, press down firmly with your hands and make your way down the entire stair nose. It may take 2 or 3 passes to set it firmly in place.

Step 5

Let the Molding Adhesive* cure for at least 4 hours before any walking on it. For exposure to full traffic, wait 24 to 48 hours.

NOTE: Complete cure takes 48 hours.

RECOMMENDED
BLADES

Carbide Tipped
Cross-Cutting
Blades

Extra Tall Stair Nose - EXTSN

Installation on flooring with an overall thickness of up to 19 mm (0.75").

"FLOATING" INSTALLATION

Flooring with an overall thickness of up to 19 mm (0.75")

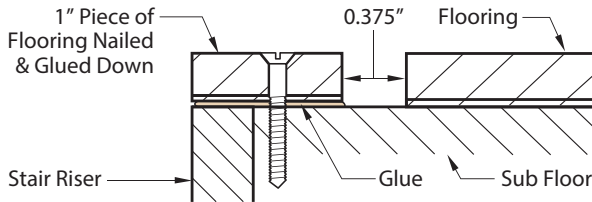

Step 1

Install the riser flush to the stair. Cut a 1" wide strip of your floor. Drill, counter-sink, screw and glue it flush to the stair riser. Install flooring 0.375" from the glued down 1" strip. **DO NOT glue flooring down.** Clean flooring and molding as directed below:

CLEANING PREPARATION FOR BOTH SURFACES

Preparing the floor & molding as outlined is mandatory to achieve the required bonding strength

1. Use a damp cloth (water only) to clean both surfaces of loose particles or surface films.
2. Roughen the surfaces with sandpaper (100-150 grit), sanding sponge or metal brush. For flooring, only roughen up area that will be covered (1.25" to 1.5").
3. Degrease both surfaces to remove all traces of oil, grease, dust, and fingerprints by using a solvent such as methyl ethyl ketone (MEK), acetone or isopropyl alcohol.
4. Let both surfaces dry thoroughly before applying Molding Adhesive.

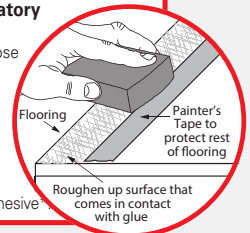

Step 2

Turn EXTSN after following the cleaning preparation above.

Step 3

Next, apply a generous bead of a Molding Adhesive* along the entire inside corner. **Be sure to NOT put adhesive towards the front of the molding.**

Underside of molding generously covered with Molding Adhesive*

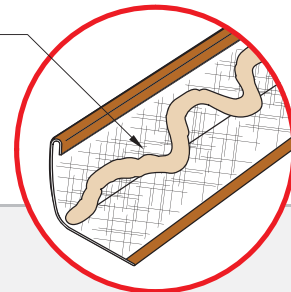

Step 4

Touch the bottom of molding to the stair riser and carefully roll the stair nose in place. Make any final adjustments before you push the molding all the way down. Once it's in the final position, press down firmly with your hands and make your way down the entire stair nose. It may take 2 or 3 passes to set it firmly in place.

Step 5

Let the Molding Adhesive* cure for at least 4 hours before any walking on it. For exposure to full traffic, wait 24 to 48 hours.

NOTE: Complete cure takes 48 hours.

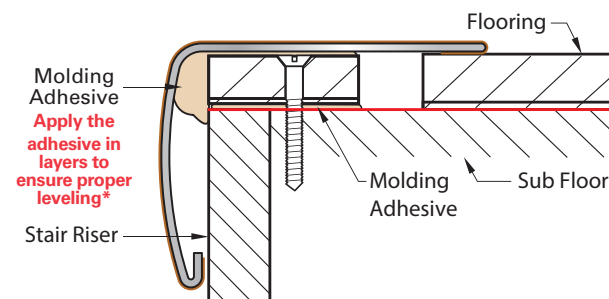
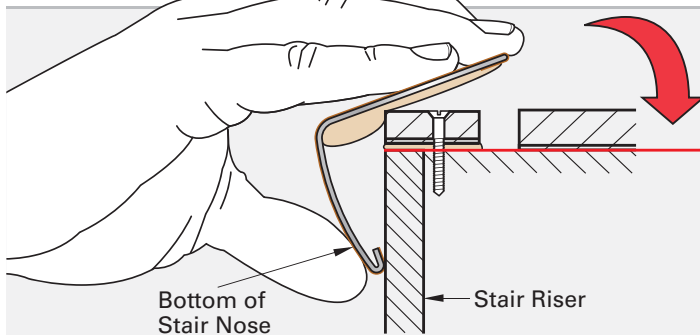
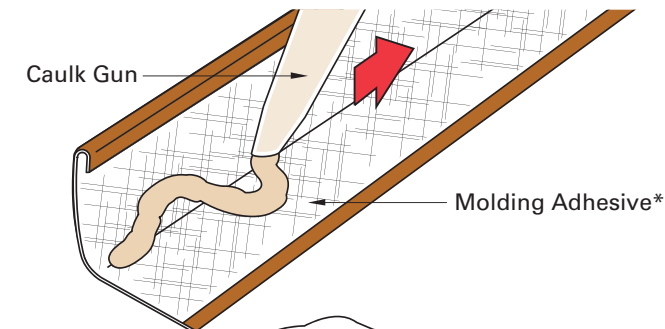
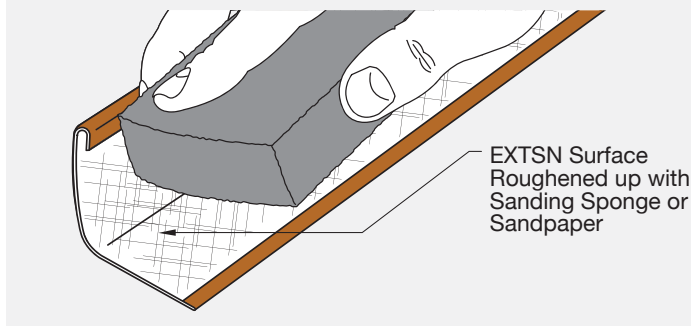

RECOMMENDED
BLADES

Carbide Tipped
Cross-Cutting
Blades

Extra Tall Stair Nose - EXTSN

Installation on **2-3 mm** LVT flooring

"Flush Lock-Down" Installation

Flooring with an overall thickness of

2-3 mm

Use EXTSN Extra Tall to Position Flooring.
Molding MUST touch flooring!

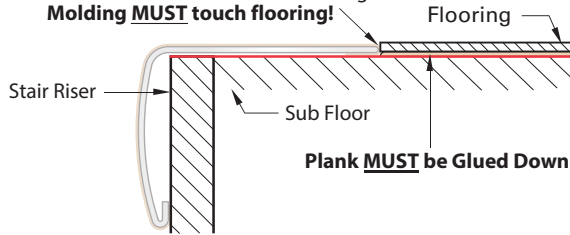

Step 1

Install the riser flush to the stair. Use EXTSN to determine where to start your flooring. EXTSN must fit snugly next to plank. Remove EXTSN and **glue the flooring plank down**. Clean flooring and molding as directed below:

CLEANING PREPARATION FOR BOTH SURFACES

Preparing the floor & molding as outlined is mandatory to achieve the required bonding strength

1. Use a damp cloth (water only) to clean both surfaces of loose particles or surface films.
2. Roughen the surfaces with sandpaper (100-150 grit), sanding sponge or metal brush. For flooring, only roughen up area that will be covered (1.25" to 1.5").
3. Degrease both surfaces to remove all traces of oil, grease, dust, and fingerprints by using a solvent such as methyl ethyl ketone (MEK), acetone or isopropyl alcohol.
4. Let both surfaces dry thoroughly before applying Molding Adhesive.

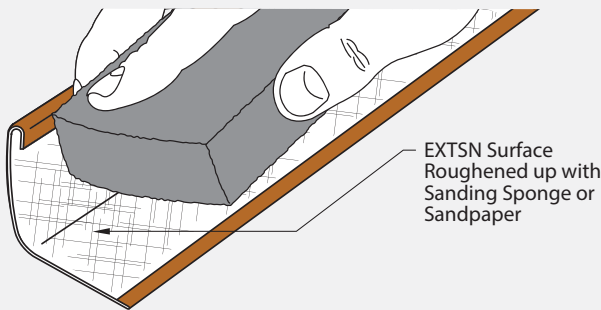
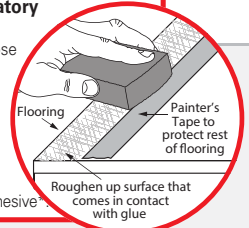

Step 2

Turn EXTSN over and roughen the inside surface of the EXTSN to increase bond by means of 60 grit sandpaper, sanding sponge, or a metal brush.

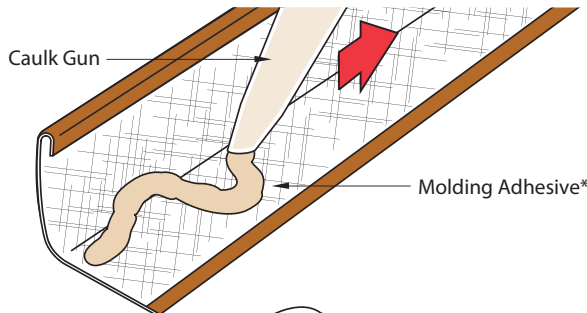

Step 3

Next, apply a generous bead of a Molding Adhesive* along the entire inside corner.

Underside of molding generously covered with Molding Adhesive*

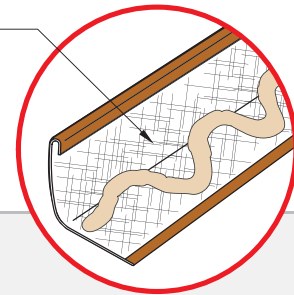

Step 4

Touch the bottom of molding to the stair riser and carefully roll the stair nose in place. Make any final adjustments before you push the molding all the way down. Once it's in the final position, press down firmly with your hands and make your way down the entire stair nose. It may take 2 or 3 passes to set it firmly in place.

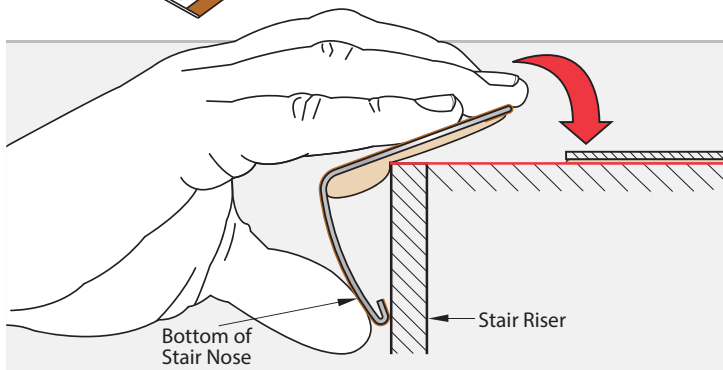

Step 5

Allow at least 24 hours for the Adhesive* to form a bond. You should always start at top of stairs and work your way down to avoid contact with the installed moldings until cured.

NOTE: Complete cure takes 48-72 hours.

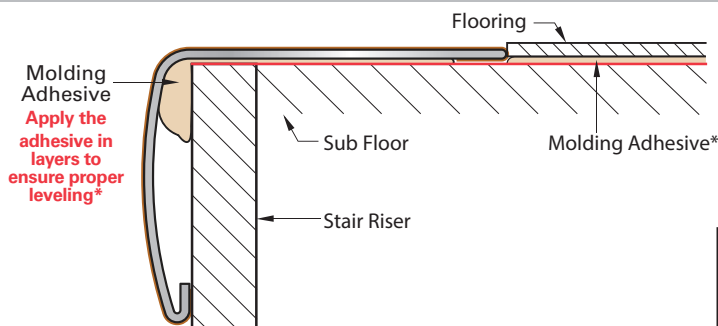

**RECOMMENDED
BLADES**

**Carbide Tipped
Cross-Cutting
Blades**

Extra Tall Stair Nose - EXTSN

Installation on **4 mm LVT flooring**

"Flush Lock-Down" Installation

Flooring with an overall thickness of

4 mm

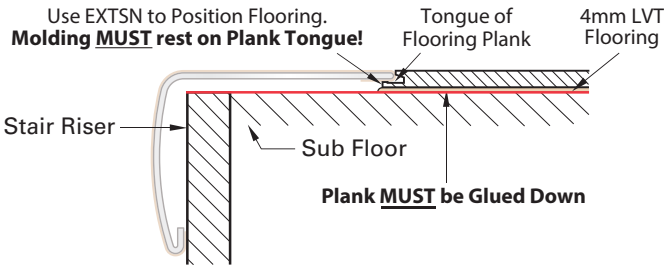

Step 1

Install the riser flush to the stair. Use EXTSN to determine where to start your flooring. **Tongue side of flooring plank MUST face EXTSN** so EXTSN can fit snugly onto Tongue. Remove EXTSN and **glue the flooring plank down**. Clean flooring and molding as directed below:

CLEANING PREPARATION FOR BOTH SURFACES

Preparing the floor & molding as outlined is mandatory to achieve the required bonding strength

1. Use a damp cloth (water only) to clean both surfaces of loose particles or surface films.
2. Roughen the surfaces with sandpaper (100-150 grit), sanding sponge or metal brush. For flooring, only roughen up area that will be covered (1.25" to 1.5").
3. Degrease both surfaces to remove all traces of oil, grease, dust, and fingerprints by using a solvent such as methyl ethyl ketone (MEK), acetone or isopropyl alcohol.
4. Let both surfaces dry thoroughly before applying Molding Adhesive.

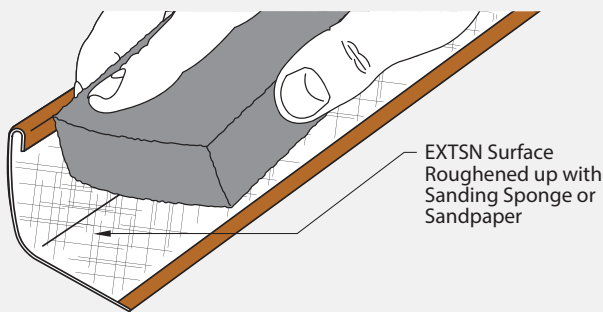
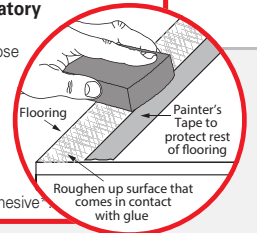

Step 2

Turn EXTSN over and roughen the inside surface of the EXTSN to increase bond by means of 60 grit sandpaper, sanding sponge, or a metal brush.

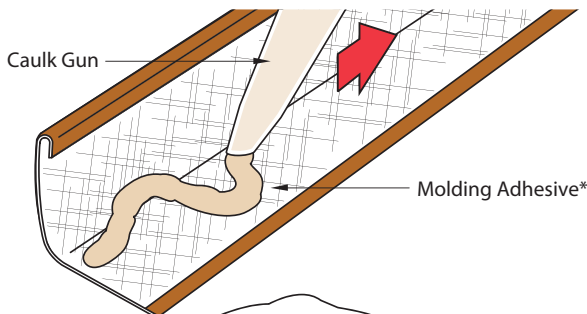

Step 3

Next, apply a generous bead of a Molding Adhesive* along the entire inside corner. Reveal edge of plank may show when EXTSN is installed. To compensate, apply a little more adhesive to the molding.

Underside of molding generously covered with Molding Adhesive*

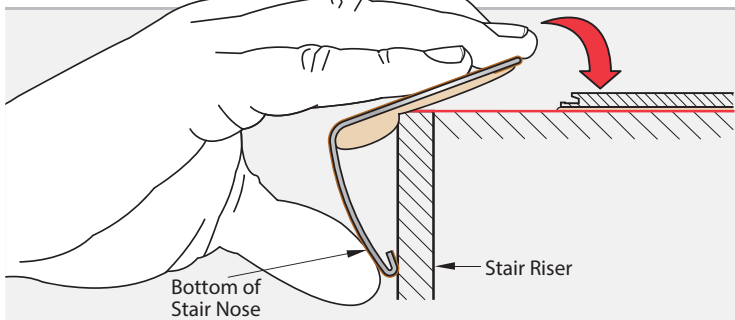
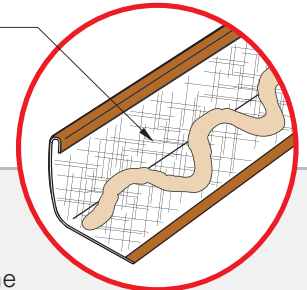

Step 4

Touch the bottom of molding to the stair riser and carefully roll the stair nose in place. Make any final adjustments before you push the molding all the way down. Once it's in the final position, press down firmly with your hands and make your way down the entire stair nose. It may take 2 or 3 passes to set it firmly in place.

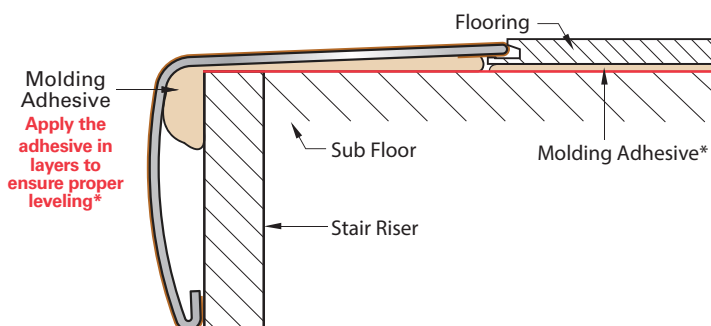

Step 5

Allow at least 24 hours for the Adhesive* to form a bond. You should always start at top of stairs and work your way down to avoid contact with the installed moldings until cured.

NOTE: Complete cure takes 48-72 hours.

**RECOMMENDED
BLADES**

**Carbide Tipped
Cross-Cutting
Blades**

* Premium Polyurethane Construction Adhesive

VINYL STAIR CAP

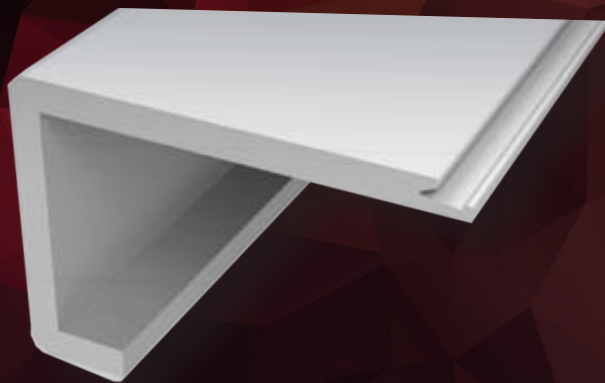

Creates a smooth and flush finish on the edges of steps by using the same vinyl flooring plank to ensure a corresponding color and texture.

Vinyl Stair Cap - VSCAP

Note: Available for Rigid Click Platform Only.

Technical Information — Sizes

Vinyl Stair Cap - VSCAP

The VSCAP is used to create matching, flush stair treads & returns that perfectly match your floor to give your staircase an elegant cohesive look.

VSCAP is made from the actual floor so it is a perfect match.

Available in Edge and/or Square Depending on Floor Type

VSCAP Edge

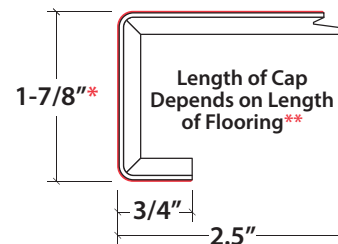

VSCAP Square

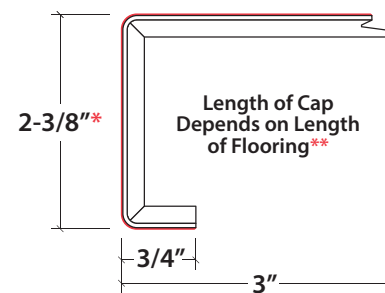

Installation

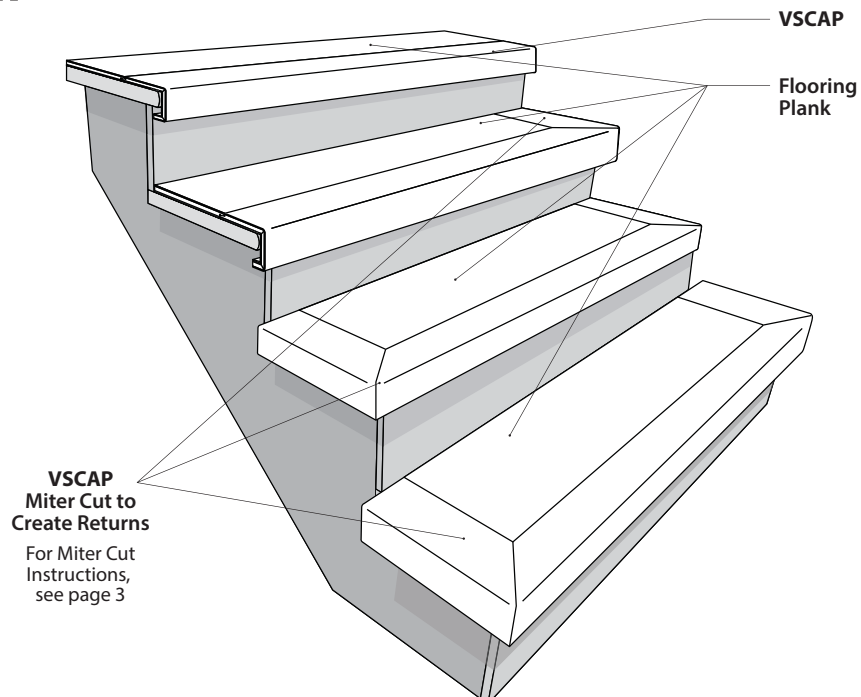

*Since flooring thicknesses vary, to find the inside height dimension of your VSCAP, measure the thickness of your floor, multiply it by 2, and subtract it from the outside height.

**VSCAPs are produced in various lengths depending on the length of the actual floor. However, regardless of the floor length, the maximum length for VSCAPs is 46 inches.

Vinyl Stair Cap - VSCAP

Basic VSCAP Installation

Daltile does **not** recommend that you join two caps together in order to complete one stair nose

Daltile does not provide custom cuts

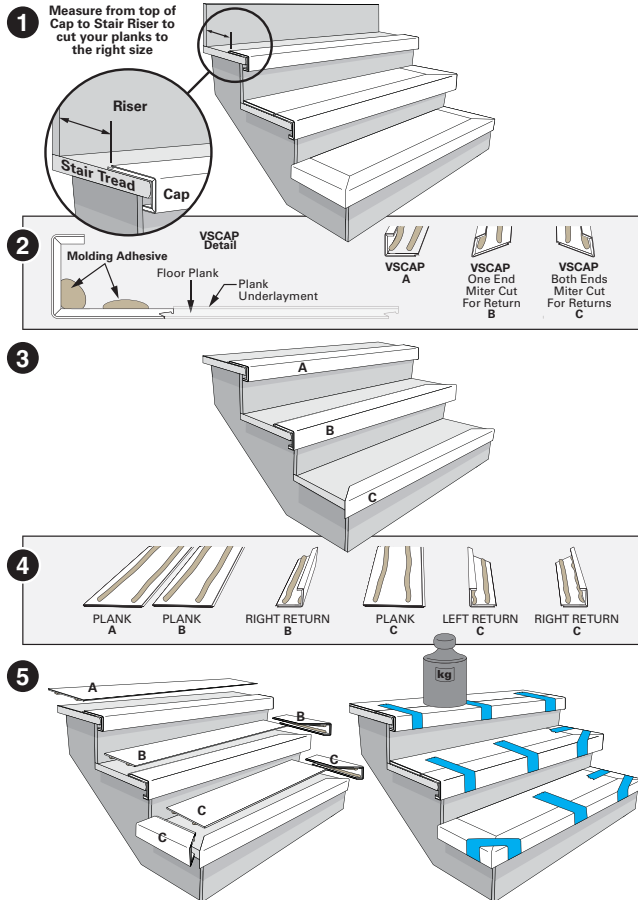

CAUTION: Depending on the floor type, the VSCAP may come with padding. If the padding is not securely attached it should be removed from the cap and/or the plank before installing to stair.

NOTE: Small broken areas (less than 1") in the locking system of your Cap will not cause any issues with installation because the cap and floor will be glued down.

Step 1

Clean the staircase from all dust and debris. All wood or concrete stair surfaces must be properly prepared, stable, flat, and free of adhesive residue or anything that may be an adhesive bond breaker. **IMPORTANT:** Installing over existing flooring on stairs is not permitted. Existing flooring must be removed.

Once staircase is clean, measure each stair and cut your planks and caps. If creating returns, use a miter saw set at 45° angles to make the cuts. Dry fit the caps, returns, & planks prior to spreading any adhesive. Leave them in place until ready to glue down.

NOTE: Start at the top of the Stair Case and work your way down. The strategy, as you will see in the steps that follow, will be to glue and staple down the VSCAP first. Then, glue down the plank and/or return(s). Move on to the next stair and repeat Steps 2 to 5.

Step 2

IMPORTANT: The VSCAP does not come with an underlayment. Apply enough adhesive to the broad flat area to make the Caps and Returns level with the floor plank. Turn the first VSCAP over and apply adhesive on the inside corner and a generous amount of molding adhesive* on the broad flat area. (See illustration on the left).

Step 3

Place the VSCAP on the stair. Position it where you want it.

Clean up any excess adhesive with a damp rag.

Step 4

Make sure the underlayment is firmly and completely attached to the floor plank. If it is not, either remove it or reattach it with PUR adhesive. Next, take the plank and/or return(s) that go with the VSCAP you just fixed on the Stair. Turn them over and apply a generous amount of molding adhesive to them. If installing returns, apply glue to the inside corner of the return and then apply adhesive to the broad flat area of the return like you did to the Cap in Step 2. (See illus. at left).

Step 5

Next, place the plank and/or return(s) in place. Clean up any excess adhesive with a damp rag before applying the painters tape.

Use painter's tape to tape the VSCAP to the flooring plank and returns. Place a heavy weight across the seams. Let the molding adhesive cure for 48 hours before heavy traffic. Once dry, you can remove painter's tape from stairs.

Next, move on to the next stair and repeat Steps 2 to 5.

HOW NOT TO INSTALL:

NO-OVERHANG STAIR TREAD

Use Options #1 or #2 at Right

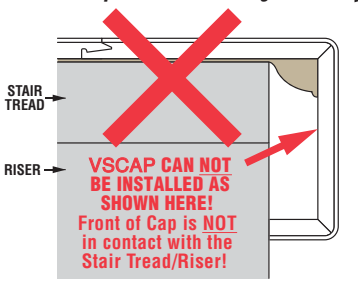

INSTALLATION OPTIONS:

NO-OVERHANG STAIR TREAD

OPTION #1: Piece of Wood Cut to Size and Screwed & Glued in Place

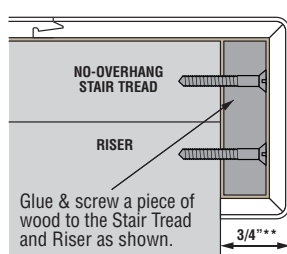

NO-OVERHANG STAIR TREAD

OPTION #2: Cut Bottom Lip of VSCAP so it Lays Flat Against Stair Tread/Riser

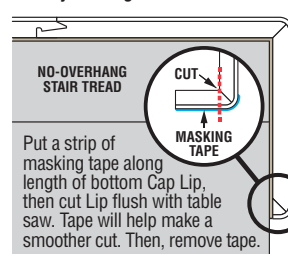

OVERHANG STAIR TREAD

Front of Cap is in Contact with Stair Riser

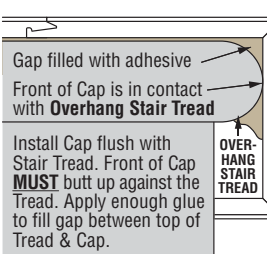

When we machine the planks we change the symmetry of tension and some bowing is to be expected. Here is how you install a slightly bowed VSCAP:

- After you cut your planks and VSCAPs to size, dry fit them to see which caps are bowing. You may see a slight 1 to 2 mm gap either towards the ends of the plank or towards the middle caused by the bowing.
- Glue your VSCAP in place on the step. Then apply glue to the back of the plank. We also advise to put a thin swipe of construction glue into the click system of the floor plank.
- Line up the plank to the VSCAP so that both ends meet.
- Start at one end and snap the plank into place by lining it up with the VSCAPs groove and lowering it down.
- Take a strip of painter's tape and start towards the very top of the flooring plank and end under the lip of the VSCAP, or even on the stair riser below the cap, pulling tightly so that the VSCAP and plank are held snug in place by the tape.
- Work your way down to the other end, pressing firmly and using your body weight to push the flooring groove into the VSCAP until it snaps into place.
- Then add strips of painter's tape to the other end and to the center of the tread to hold the VSCAP in place until the glue dries. Apply weights.

**Per 2018 Building code (IBC R311.7.5.3) an overhang stair tread of not less than 3/4" is required when treads are less than 11" deep, but please make sure to check with your local code officials as local jurisdictions have their own rules.

Vinyl Stair Cap - VSCAP

Cutting VSCAP to Create Returns

Daltile does not provide custom cuts

Make sure to use safety goggles and thick gloves while using saw and handling the blade

Step 1 – MAKE TEST CUTS ON SCRAP 2x4

IMPORTANT: Make sure the bevel angle is set to ZERO (A).

We highly recommend you do a test cut on 2 scrap pieces of 2x4 to make sure your cuts line up. Set the miter angle to 45 degrees for the first cut (B). Cut the 2x4 (C).

Then change angle of miter cut to 45 degrees in the other direction (D). Cut the other piece of 2x4.

Line up ends of the 2x4s to form a corner (E). Check the pieces to see if they line up correctly with **no gap** on the top or front view (F).

Step 2 – CUT YOUR VSCAP

IMPORTANT: Use a scrap 2x4 piece to set VSCAP on while you make the cuts (G). This will keep them level as you cut.

Set the miter angle to 45 degrees. Cut the VSCAP (H).

REMINDER: Always wear safety goggles when using the saw

IMPORTANT: Hold the VSCAP extremely tight, otherwise it will pull in the direction of the blade and your cut will be off

Change miter angle to 45 degrees in the other direction (I). Cut the other piece that you are using for the Return. Again, **make sure you hold the VSCAP extremely tight. Don't let it move while you make the cut.**

Check the Cap & Return to see if they line up correctly with **no gap** on the top or front view (J).

Step 3 – APPLYING CAP & RETURN TO THE STAIRS

IMPORTANT: The VSCAP does not come with an underlayment. Apply enough adhesive to the broad flat area to make the Caps & Returns level with the floor plank.

After wiping the Cap & Return clean from debris, test the fit on your stairway. Make sure there is no gap between them (M).

After you test the fit, run thick lines of **molding adhesive*** along the inside corner and along the broad flat surface of the VersaCap (N).

Put the Cap in place, pressing down firmly to make sure it is in contact with the stair (O). Make sure the edge is square.

Clean up any excess adhesive with a damp rag.

IMPORTANT: Make sure the underlayment is firmly and completely attached to the floor plank. If it is not, either remove it or reattach it with PUR adhesive.

Next, take the plank and Return that go with the VSCAP you just fixed on the Stair. Turn them over and apply a generous amount of **molding adhesive** to them. Apply glue to the inside corner of the return and then apply adhesive to the broad flat area.

Next, place the plank and Return in place (P).

Clean up any excess adhesive with a damp rag before applying the painter's tape.

While pressing both ends firmly together, stretch a piece of painter's tape tightly across the corner edge to keep the moldings from separating while the adhesive cures (Q).

Place a heavy weight across the seams (R).

Let the Molding Adhesive cure for 48 hours before heavy traffic. Once dry, you can remove painter's tape from stairs.

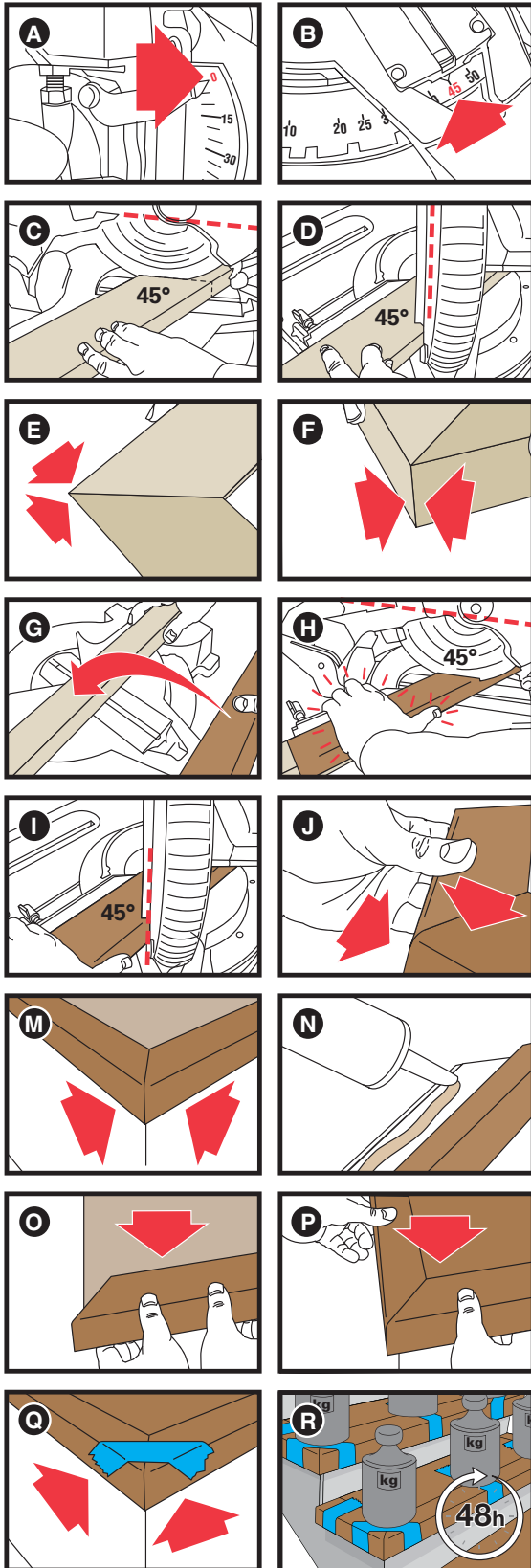

* Premium Polyurethane Construction Adhesive

SLIM TRIM 4-IN-1 TRANSITION



T-Molding



Hard Surface
Reducer



End Molding



Carpet Transition

Performance Accessories' exclusive 4-in-1 transition allows you to utilize a single transition for four different applications.

Slim Trim

Note: Available for both Rigid Click and Flexible Glue Down Platforms.

Technical Information — Sizes

SlimTrim

Our SlimTrim functions as a Reducer, T-Molding, and End Cap. Comes with track & shim for floors up to 1/4" (6.35mm) or dowels for floors up to 3/4" (19mm). See illustrations below for details.

Surface Material: High Wear Resistant Aluminum Oxide Laminate

Core Material: PVC

Track

To be used with SlimTrim for floors up to 1/8" (3mm) thickness. Also, used in conjunction with the Shim for 1/8"-1/4"* (3-6.35mm). See illustrations below for details.

Material: Cold Roll Steel

* For floors thicker than 1/4" (6.35mm), use dowel installation

Shim

Used with SlimTrack installation to extend thickness range.

Material: Standard HDF

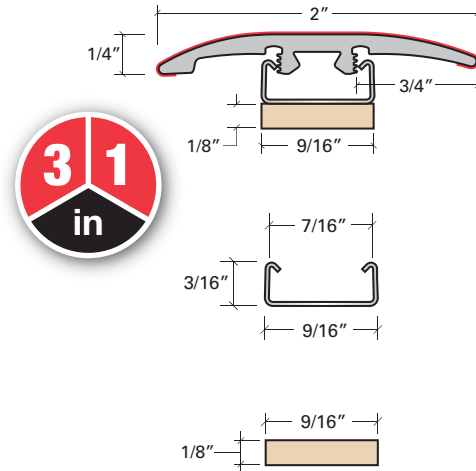

Installation*

LVT Floors

1 Hard Surface Reducer:

Up to 1/4"
(0-6.35mm)**



Track

2 T-Molding:

1/16 to 1/8"
(1.6-3mm)**

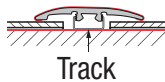

Track

1/8-1/4"
(3-6.35mm)**

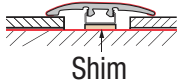

Shim

3 Carpet Transition:

Hard Surface to Carpet

Up to 1/4"
(0-6.35mm)**

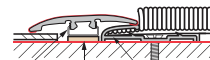

Track Shim Carpet Transition

4 End Molding:

Hard Surface to Threshold,
Sliding Door, etc.

Up to 1/4"
(0-6.35mm)**

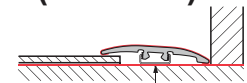

Track

*The installation instructions shown on this page are suggestions of how to install our moldings. Daltile does not assume responsibility for any product failure or liability due to installations that are in violation of the flooring manufacturer's installation guidelines and/or warranties.

**All references to flooring thickness refer to the total thickness of all members of the floor installation being laid upon the subfloor. This typically is comprised of the flooring plank, e.g. Vinyl, the underlayment, either attached or loose lay and any additional vapor barriers.

PROSERIES™ SLIM TRIM 4-In-1 Transition

SlimTrim as a Hard Surface Reducer

Use Track (Metal Track) for up to 6.35 mm floors.

**If the flooring manufacturer suggests/permits the use of underpayments, you may need to shim the track to accommodate the increase in overall thickness*

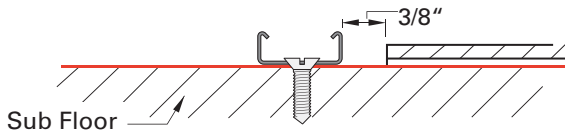

IMPORTANT: Rock SlimTrim back & forth to make sure it is sitting inside the track BEFORE hammering in!

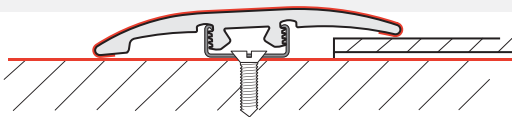
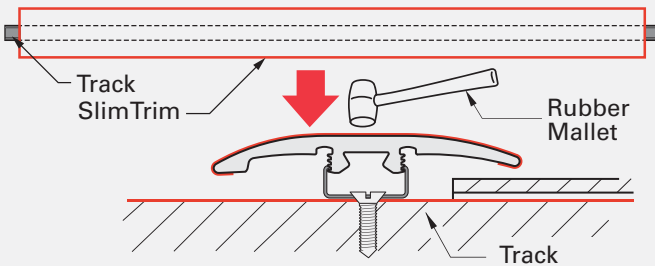

Use SlimTrack & Shim for 6.35-9.5 mm floors. Use the same molding & track, just add Shim.

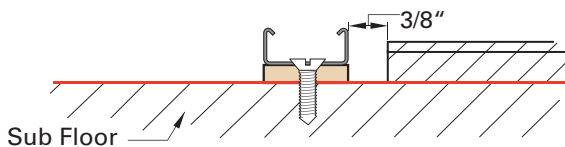

IMPORTANT: Rock SlimTrim back & forth to make sure it is sitting inside the track BEFORE hammering in!

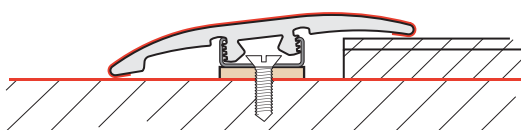
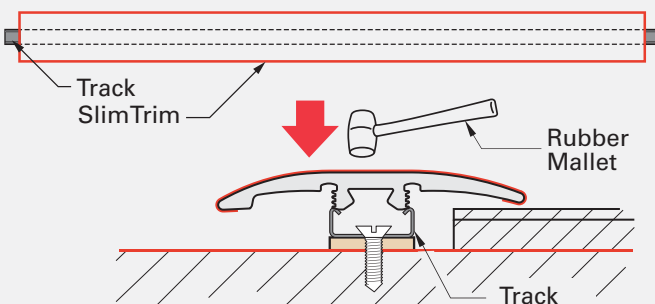

Up to 1/4" (6.35 mm) Floors

This end of the SlimTrim MUST be placed on the lower of the two surfaces.

Step 1

Install the flooring plank*. Then place the Track 3/8" from the floor and screw it to the sub-floor using #6 screws.



If SlimTrim wiggles back and forth, it is NOT set in the track properly and will be damaged when hammered in!

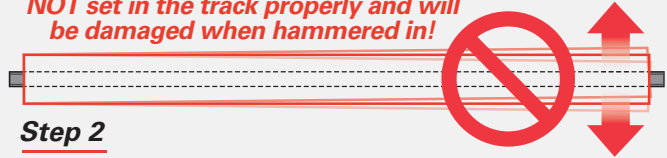

Step 2

Line the SlimTrim molding up with the Track and fit one end into the molding. Using a rubber mallet, tap the molding until it engages with the track. **Use your hand to guide the molding into the track as you work your way down**, tapping it in, similar to how you would close a zip-loc bag.

Step 3

Next, go up and down the molding several times, tapping the SlimTrim all the way into the track. You can use a little more force once you are sure it is properly engaged in the track.



For 6.35 - 9.5mm WPC/LVT Floors

This end of the SlimTrim MUST be placed on the lower of the two surfaces.

Step 1

Install the flooring plank*. Then place the track & shim 3/8" from the floor and screw it to the sub-floor using #6 screws.



If SlimTrim wiggles back and forth, it is NOT set in the track properly and will be damaged when hammered in!

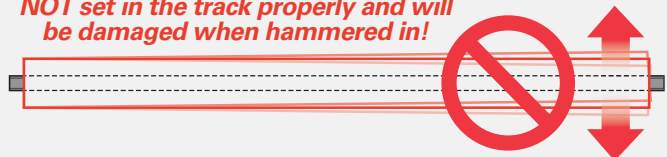

Step 2

Line the SlimTrim molding up with the Track and fit one end into the molding. Using a rubber mallet, tap the molding until it engages with the track. **Use your hand to guide the molding into the track as you work your way down**, tapping it in, similar to how you would close a zip-loc bag.

Step 3

Next, go up and down the molding several times, tapping the SlimTrim all the way into the track. You can use a little more force once you are sure it is properly engaged in the track.

PROSERIES™ SLIM TRIM 4-In-1 Transition

SlimTrim as a T-Molding

Use Track (Metal Track) for 1.6 - 3 mm floors.



1/16 to 1/8" (1.6-3 mm) Floors

**If the flooring manufacturer suggests/permits the use of underlayments, you may need to shim the track to accommodate the increase in overall thickness*

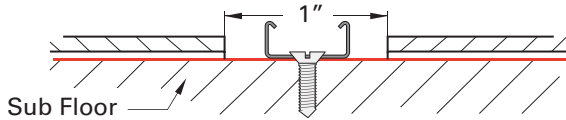

Step 1

Install the flooring planks* by leaving a 1" inch (25mm) gap for the installation of the SlimTrim. Center the track between the two laminate floors and screw it to the sub floor by using #6 screws.

IMPORTANT: Rock SlimTrim back & forth to make sure it is sitting inside the track BEFORE hammering in!

If SlimTrim wiggles back and forth, it is NOT set in the track properly and will be damaged when hammered in!

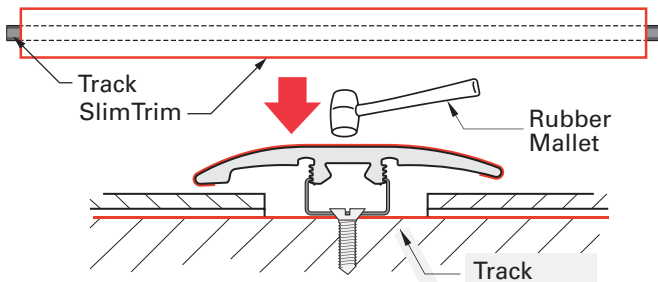
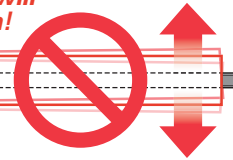

Step 2

Line the SlimTrim molding up with the Track and fit one end into the molding. Using a rubber mallet, tap the molding until it engages with the track. **Use your hand to guide the molding into the track as you work your way down**, tapping it in, similar to how you would close a zip-loc bag.

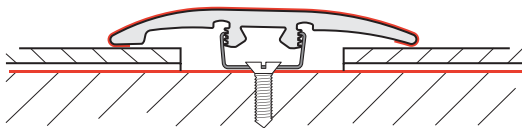

Step 3

Next, go up and down the molding several times, tapping the SlimTrim all the way into the track. You can use a little more force once you are sure it is properly engaged in the track.

Use Track & Shim for 4-6.35 mm floors. Use the same molding & track, just add shim.

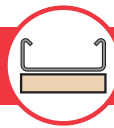

1/8 to 1/4" (3-6.35 mm) Floors

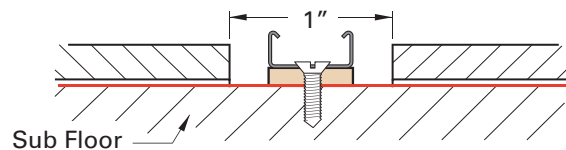

Step 1

Install the flooring planks by leaving a 1" inch (25mm) gap for the installation of the SlimTrim. Center the track and shim between the two laminate floors and screw them to the sub floor by using #6 screws.

IMPORTANT: Rock SlimTrim back & forth to make sure it is sitting inside the track BEFORE hammering in!

If SlimTrim wiggles back and forth, it is NOT set in the track properly and will be damaged when hammered in!

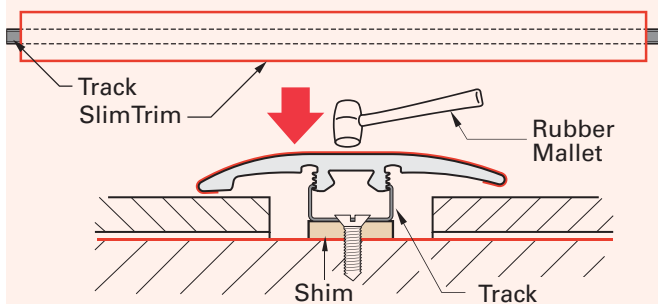
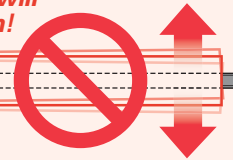

Step 2

Line the SlimTrim molding up with the Track and fit one end into the molding. Using a rubber mallet, tap the molding until it engages with the track. **Use your hand to guide the molding into the track as you work your way down**, tapping it in, similar to how you would close a zip-loc bag.

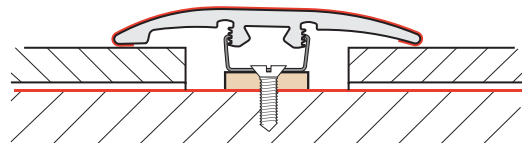

Step 3

Next, go up and down the molding several times, tapping the SlimTrim all the way into the track. You can use a little more force once you are sure it is properly engaged in the track.

PROSERIES™ SLIM TRIM 4-In-1 Transition

SlimTrim as a Carpet Transition

Use Track & Shim for up to 6.35 mm floors. Use the same molding & track, just add shim.

NOTE: Carpet Tap Down trim must be even with the top of the track.

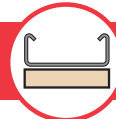
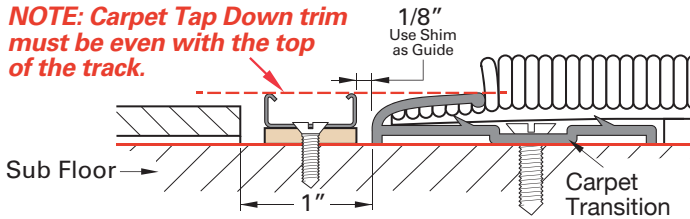

Up to 1/4" (0-6.35 mm) Floors

Step 1

Install the flooring plank and carpet (using a carpet tap down trim) by leaving a 1" inch (25mm) gap for the installation of the SlimTrim. Position the track 3/4" from where the of the Carpet Transition trim meets the carpet and screw them to the sub floor by using #6. The Carpet Transition trim must be even with the top of the track.

IMPORTANT: Rock SlimTrim back & forth to make sure it is sitting inside the track BEFORE hammering in!

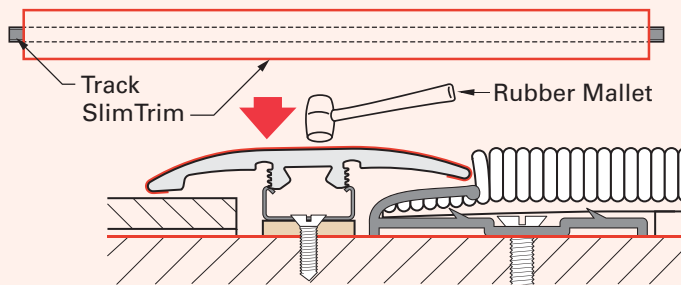

If SlimTrim wiggles back and forth, it is NOT set in the track properly and will be damaged when hammered in!

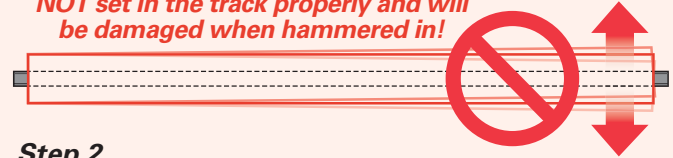

Step 2

Line the SlimTrim up with the track and fit one end into the molding. Using a rubber mallet, tap the molding until it engages with the track. **Use your hand to guide the molding into the track as you work your way down**, tapping it in, similar to how you would close a zip-loc bag.

Step 3

Next, go up and down the molding several times, tapping the SlimTrim all the way into the track. You can use a little more force once you are sure it is properly engaged in the track.

this end MUST be placed on the lower surface

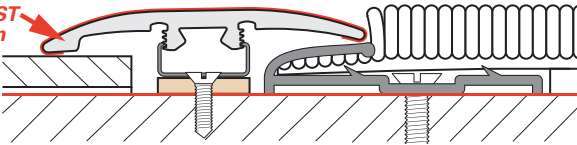

FULL ROUND STAIR TREAD



A vinyl stair tread with pre-attached stair nosing.
Can be used on steps with or without nosing.

SPECIFICATIONS

- 12-1/5" W x 50" L x 5/16" T
(50" includes the width of left and right returns.
The length without returns is 48")
- Thickness of "overlap": 1.7"
- 1 piece per carton
- 100% Waterproof, kidproof, petproof
- Pre-attached nosing for easy front installation
- Includes end cap to be cut to size for the right or left side, the adhere to tread for open staircases
- Seamless one-piece stair tread
- Meets building code

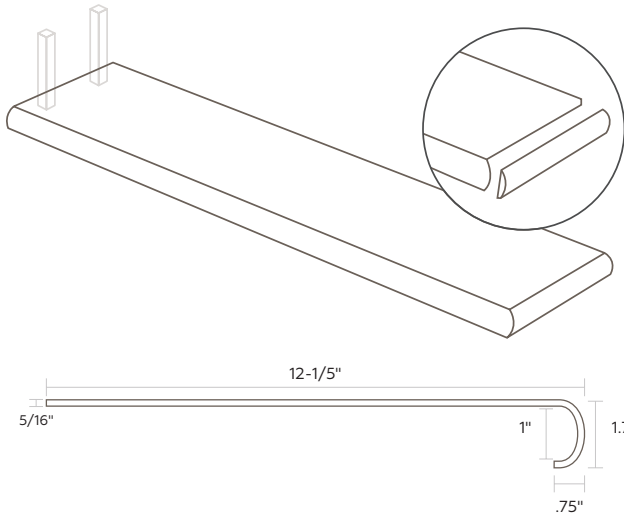

TOOLS & MATERIALS

- ✓ Gloves, Safety Glasses, Dust Mask
- ✓ Measuring Tape
- ✓ Pliers
- ✓ Hammer
- ✓ Vacuum
- ✓ 5 in 1 Tool/Scraper
- ✓ Heavy Duty, Urethane Construction Adhesive
- ✓ Caulking Gun
- ✓ Sliding Miter Saw With Carbide Tipped Blade
- ✓ Table Saw With Carbide Tipped Blade
- ✓ T-Bevel or Angle Gauge
- ✓ 100 Grit Sandpaper
- ✓ Brad/Finish Nailer
- ✓ Denatured Alcohol
- ✓ Matching Wood Filler

PREPARING FOR INSTALLATION

The **FULL ROUND STAIR TREAD** can be installed on steps with or without nosing. Any stair nosing greater than 1" thick and .25" deep will require to be uninstalled creating a squared off step. This can be achieved by utilizing a circular saw to cut off as much overhang to position it as close to the stringers as possible. A hammer and chisel can be used to remove the remaining end portions.

Prior to installation of the **FULL ROUND STAIR TREAD**:

1. The entire staircase should be clean. by removing any carpet, staples and padding. Any nails that are inhibiting installation must be flattened. Remove any debris or obstruction that might interfere with the installation by vacuuming the stairs.
2. It is imperative that the staircase is structurally stable by repairing or reinforcing any steps that may be loose or create noise.

If staircase has pre-existing spindles, make sure to remove prior to **FULL ROUND STAIR TREAD** installation. After stair tread installation, is completed, re install the spindles. Do not cut stair tread around existing spindles.

MEASURING/FITTING

FULL ROUND STAIR TREADS

3. Measure the width of each step, from stringer to stringer, where the riser meets the step, as well as the front portion of the step or the stringer to step end for Open Steps. **Use a T-Bevel or Angle Gauge** to assure a proper fit as each step will vary in size. Transfer these measurements to the **FULL ROUND STAIR TREAD**.
4. For "open steps" cut one side of the expose side profile or for "boxed steps" cut both sides of the **FULL ROUND STAIR TREAD** with a sliding miter saw.
5. Once the step has been carefully measured, cut the entire length of the each **FULL ROUND STAIR TREAD** with a table saw to the specific dimension.

INSTALLING

6. The **FULL ROUND STAIR TREAD**, should be installed from the bottom of the staircase to the top, beginning with the bottom riser. Then alternate by installing tread, riser, tread riser until entire staircase is completed.
7. Lightly sand the back of the **FULL ROUND STAIR TREAD** with 100 grit sandpaper and wipe the surface with denatured alcohol applied to a clean cloth to aid in adhesion. This will improve the adhesion of the tread to the step.
8. Apply a 1/4" bead of Heavy Duty Urethane Construction Adhesive to the back side of the bottom riser around the perimeter as well as a serpentine bead throughout the middle.
9. Fit riser into place and reinforce with brad nails at the top if necessary. Place the nail close enough to the top edge so that the following **FULL ROUND STAIR TREAD** covers the nail holes.

10. Apply adhesive to the next **FULL ROUND STAIR TREAD** in the sequence and fit into place.
11. Repeat all steps until staircase is completed.
12. Secure each tread with 2 to 3 brad nails across the width of the tread without getting too close to 1/4 inch from the current riser. The tread riser will be used to cover any brad nails installed. This process will assist keeping the **FULL ROUND STAIR TREAD** in place while installing from bottom to top.
13. For "open steps", place the included edge cap by the side of the stair tread to check that the miter aligns with the tread. Verify where the edge cap will end and mark with a pencil the short end where the 45-degree cut will be done. Once the edge cap is cut, drill 2 pilot holes into the edge cap. The holes need to be 4" apart from each other. Insert the dowels into the holes and use the dowels to mark where the holes in the substrate need to be drilled. Mark the holes on the substrate and drill the holes to insert the dowels into place. Add glue to attach the edge cap onto the substrate and full stair tread. Glue on the 45-degree return to the edge cap in order to cover the raw edge. For a stronger bond, add brad nails and fill the holes with putty.
14. To conceal the raw end of the riser, an end cap can be attached to give a finished look.

TOP STEP

15. To finish the top step, use a coordinating Extra Tall Stair Nose, or a Round Stair Nose. A Vinyl Stair Cap also can be used if the product installed is rigid click product.

FINAL DETAILS

16. Caulk needs to be used to fill any gaps around treads and risers.

ROUND STAIR NOSE

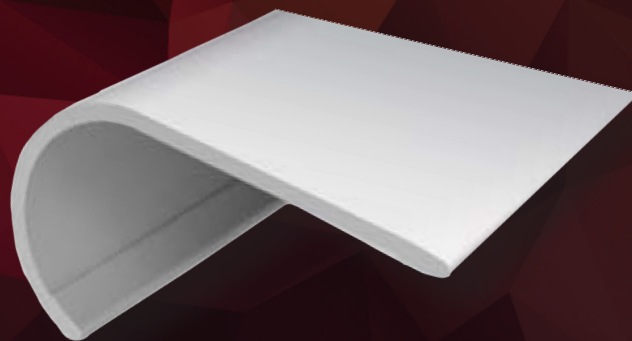

Creates a transition to the edge of the step by overlapping the flooring on the back end. Can also be installed flush on floors with an overall thickness up to 4 mm.*

* References to flooring thickness refer to the total thickness of all members of the floor installation being laid upon the subfloor. This typically is comprised of the flooring plank, e.g. Vinyl or Laminate, the underlayment, either attached or loose lay and any additional vapor barriers.

Round Stair Nose

Note: Available for both Rigid Click and Flexible Glue Down Platforms.

Technical Information — Sizes

Round Stair Nose

The Round Stair Nose combines style and function to enhance the beauty of a staircase or step. For use on flooring with an overall thickness of up to 19 mm (0.75").

Surface Material: High Wear Resistant Aluminum Oxide Laminate

Core Material: PVC

Shim

To be used with the Round Stair Nose for floors in flush installations (See illustrations at bottom right).

Material: Standard MDF/HDF

Bullnose Shim

To be used to install the RSN on **Box Staircases** to create a rounded step and to add more stabilization for the Stair Nose.

Material: Standard MDF

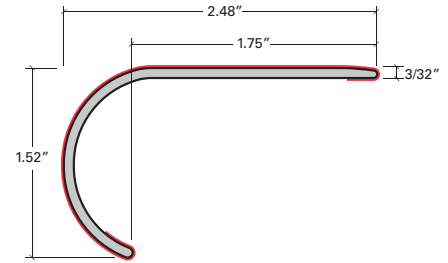

Installation*

Overlap Install

“Lock-Down” Installs

Used where floating of the floor is not required, as with Stair Tread or Glued-Down/Nailed-Down floors. This can be used on floating floors where expansion and contraction will occur on the opposite side of the flooring plane.

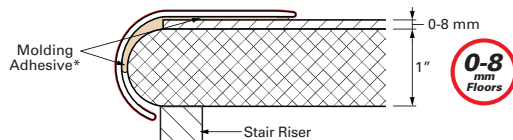

“Floating” Install

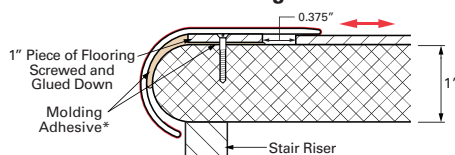

Flush Install

“Lock-Down” Installs

Used where floating of the floor is not required, as with Stair Tread or Glued-Down/Nailed-Down floors. This can be used on floating floors where expansion and contraction will occur on the opposite side of the flooring plane.

Tongue side of plank MUST face the Stair Nose. Stair Nose, Shims, and flooring planks must be glued down to subfloor.

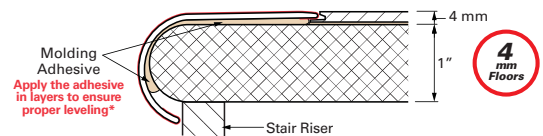
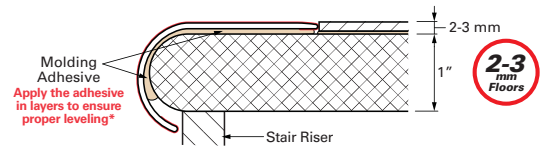

Round Stair Nose

Overlap "Lock-Down" Installation

Flooring with an overall thickness of

0-8 mm

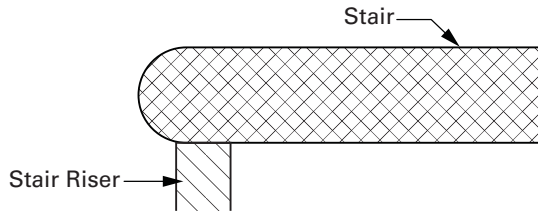

Step 1

Install the riser flush to the stair. Glue down flooring planks (for more details see manufacturers recommendations). Then, clean flooring and molding as directed below:

CLEANING PREPARATION FOR BOTH SURFACES

Preparing the floor & molding as outlined is mandatory to achieve the required bonding strength

1. Use a damp cloth (water only) to clean both surfaces of loose particles or surface films.
2. Roughen the surfaces with sandpaper (100-150 grit), sanding sponge or metal brush. For flooring, only roughen up area that will be covered (1.25" to 1.5").
3. Degrease both surfaces to remove all traces of oil, grease, dust, and fingerprints by using a light solvent such as isopropyl alcohol (Refer to the manufacturer's recommendations for additional safe cleaning agents).
4. Let both surfaces dry thoroughly before applying adhesive.

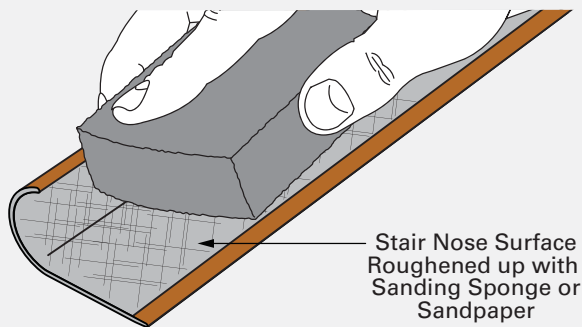
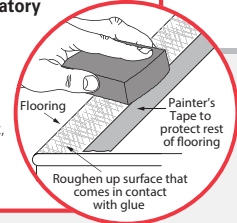

Step 2

Turn Stair Nose over and roughen the inside surface of the molding to increase bond by means of 60 grit sandpaper, sanding sponge, or a metal brush.

Step 3

Next, apply a generous bead of a Molding Adhesive* along the entire inside corner.

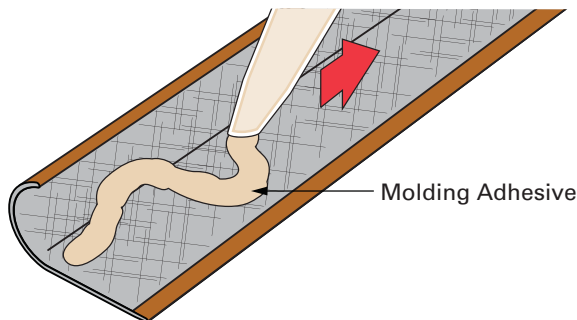

Underside of molding generously covered with Molding Adhesive

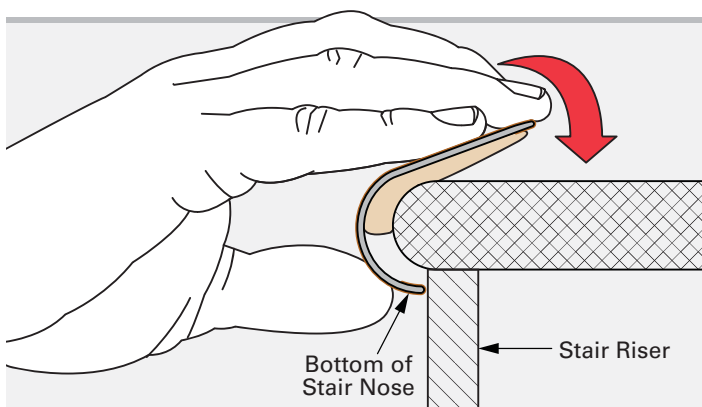
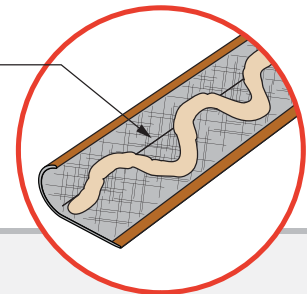

Step 4

Touch the bottom of molding to the stair riser and carefully roll the Stair Nose in place. Make any final adjustments before you push the molding all the way down. Once it's in the final position, press down firmly with your hands and make your way down the entire stair nose. It may take 2 or 3 passes to set it firmly in place.

Step 5

Allow at least 24 hours for the Molding Adhesive to form a bond. You should always start at top of stairs and work your way down to avoid contact with the installed moldings until cured.

NOTE: Complete cure takes 48-72 hours.

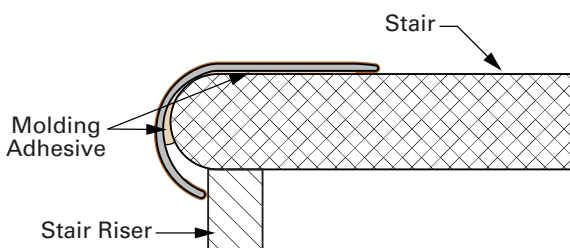

* Premium Polyurethane Construction Adhesive

Round Stair Nose

Overlap "Floating" Installation

Flooring with an overall thickness of

0-8 mm

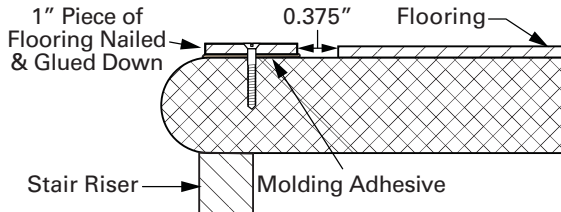

Step 1

Install the riser flush to the stair. Cut a 1" wide strip of your floor. Drill, counter-sink, screw and glue it flush to the stair riser. Install flooring 0.375" from the glued down 1" strip. **DO NOT glue flooring down.** Clean flooring and molding as directed below:

CLEANING PREPARATION FOR BOTH SURFACES

Preparing the floor & molding as outlined is mandatory to achieve the required bonding strength

1. Use a damp cloth (water only) to clean both surfaces of loose particles or surface films.
2. Roughen the surfaces with sandpaper (100-150 grit), sanding sponge or metal brush. For flooring, only roughen up area that will be covered (1.25" to 1.5").
3. Degrease both surfaces to remove all traces of oil, grease, dust, and fingerprints by using a light solvent such isopropyl alcohol (Refer to the manufacturer's recommendations for additional safe cleaning agents).
4. Let both surfaces dry thoroughly before applying adhesive.

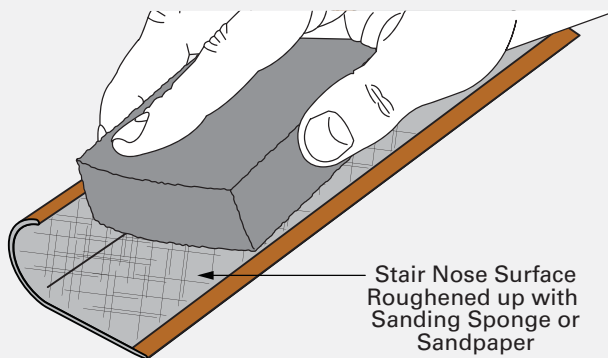
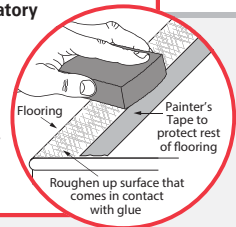

Step 2

Turn Stair Nose over and roughen the inside surface of the molding to increase bond by means of 60 grit sandpaper, sanding sponge, or a metal brush.

Step 3

Next, apply a generous bead of a molding adhesive* along the entire inside corner.

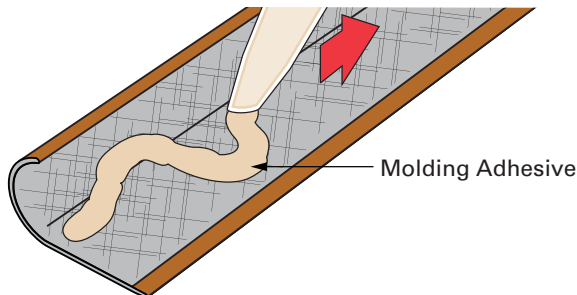

Underside of molding generously covered with molding adhesive

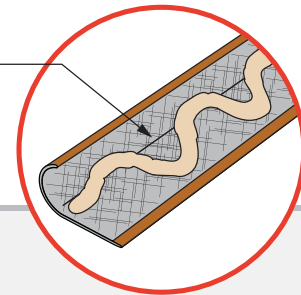

Step 4

Touch the bottom of molding to the stair riser and carefully roll the Stair Nose in place. Make any final adjustments before you push the molding all the way down. Once it's in the final position, press down firmly with your hands and make your way down the entire stair nose. It may take 2 or 3 passes to set it firmly in place.

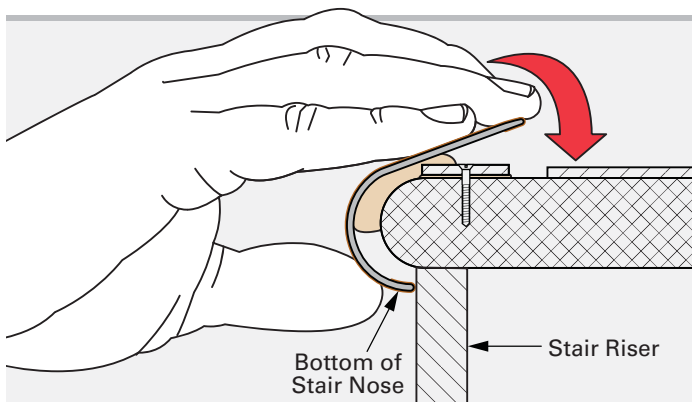

Step 5

Allow at least 24 hours for the molding adhesive to form a bond. You should always start at top of stairs and work your way down to avoid contact with the installed moldings until cured.

NOTE: Complete cure takes 48-72 hours.

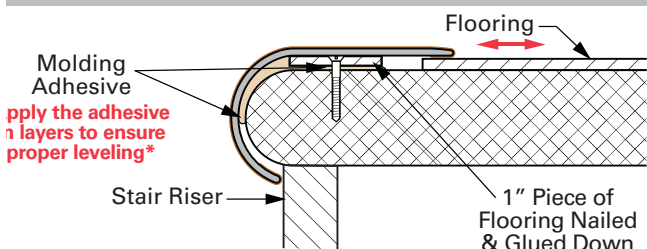

* Premium Polyurethane Construction Adhesive

Round Stair Nose

Flush "Lock-Down" Installation

Flooring with an overall thickness of

**2-3
mm**

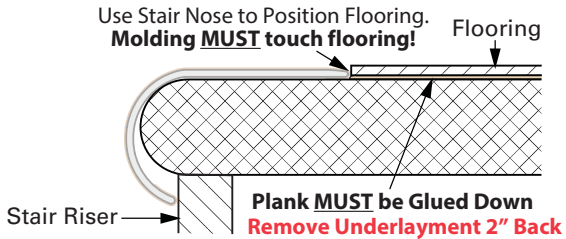

Step 1

Install the riser flush to the stair. Use Stair Nose to determine where to start your flooring. Stair Nose must fit snugly next to plank. Remove Stair Nose and **glue the flooring plank down. Remove underlayment 2" back** from floor before you glue plank down. Clean flooring and molding as directed below:

CLEANING PREPARATION FOR BOTH SURFACES

Preparing the floor & molding as outlined is mandatory to achieve the required bonding strength

1. Use a damp cloth (water only) to clean both surfaces of loose particles or surface films.
2. Roughen the surfaces with sandpaper (100-150 grit), sanding sponge or metal brush. For flooring, only roughen up area that will be covered (1.25" to 1.5").
3. Degrease both surfaces to remove all traces of oil, grease, dust, and fingerprints by using a light solvent such isopropyl alcohol (Refer to the manufacturer's recommendations for additional safe cleaning agents).
4. Let both surfaces dry thoroughly before applying adhesive.

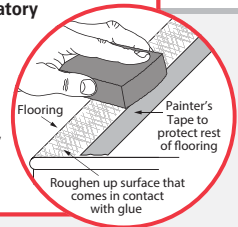

Step 2

Turn Stair Nose over and roughen the inside surface of the Stair Nose to increase bond by means of 60 grit sandpaper, sanding sponge, or a metal brush.

Step 3

Next, apply a generous bead of a molding adhesive* along the entire inside corner.

Underside of molding generously covered with molding adhesive

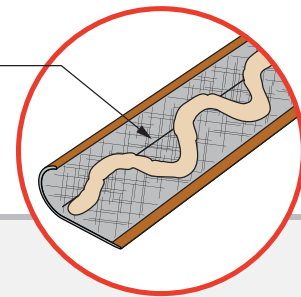

Step 4

Touch the bottom of molding to the stair riser and carefully roll the Stair Nose in place. Make any final adjustments before you push the molding all the way down. Once it's in the final position, press down firmly with your hands and make your way down the entire stair nose. It may take 2 or 3 passes to set it firmly in place.

Step 5

Allow at least 24 hours for the molding adhesive to form a bond. You should always start at top of stairs and work your way down to avoid contact with the installed moldings until cured.

NOTE: Complete cure takes 48-72 hours.

* Premium Polyurethane Construction Adhesive

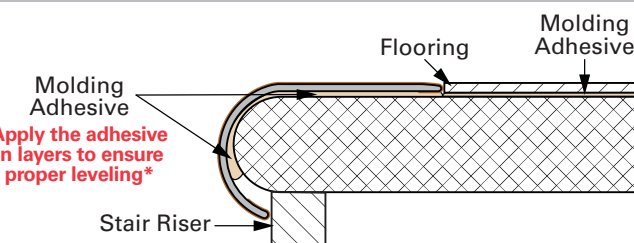
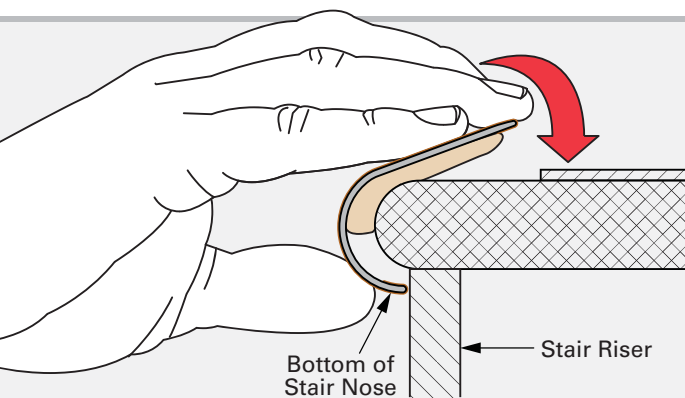
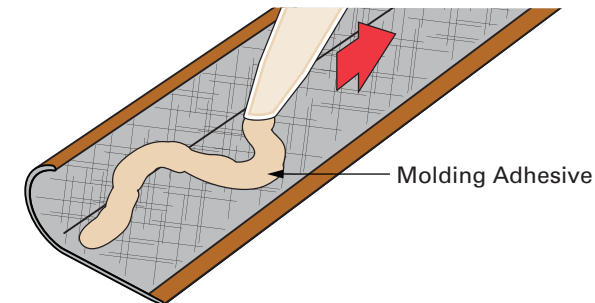
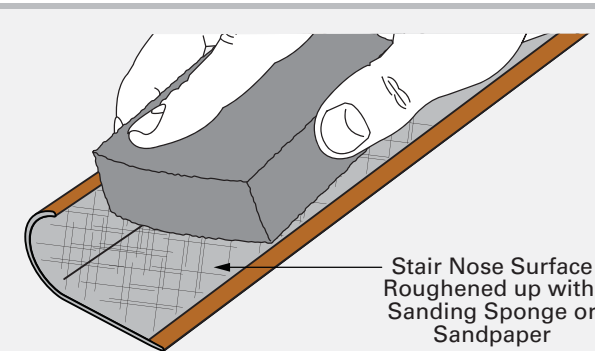

Round Stair Nose

Flush "Lock-Down" Installation

Flooring with an overall thickness of

**4
mm**

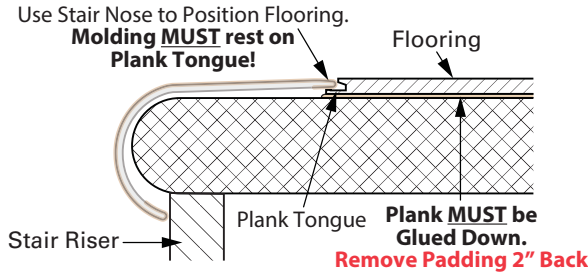

Step 1

Install the riser flush to the stair. Use Stair Nose to determine where to start your flooring. **Tongue side of flooring plank MUST face Stair Nose** so Stair Nose can fit snugly onto Tongue. Remove Stair Nose and **glue the flooring plank down. Remove padding 2" back** from plank before you glue it down. Clean flooring and molding as directed below:

CLEANING PREPARATION FOR BOTH SURFACES

Preparing the floor & molding as outlined is mandatory to achieve the required bonding strength

1. Use a damp cloth (water only) to clean both surfaces of loose particles or surface films.
2. Roughen the surfaces with sandpaper (100-150 grit), sanding sponge or metal brush. For flooring, only roughen up area that will be covered (1.25" to 1.5").
3. Degrease both surfaces to remove all traces of oil, grease, dust, and fingerprints by using a light solvent such as isopropyl alcohol (Refer to the manufacturer's recommendations for additional safe cleaning agents).
4. Let both surfaces dry thoroughly before applying adhesive.

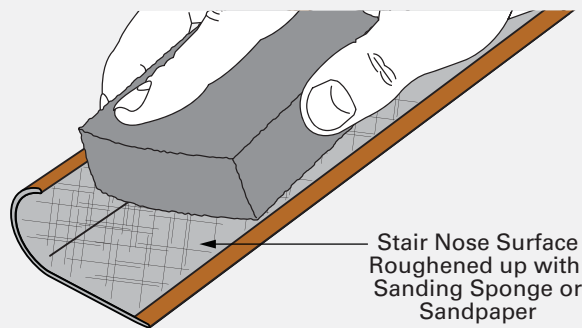
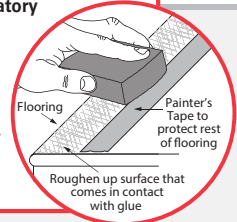

Step 2

Turn Stair Nose over and roughen the inside surface of the Stair Nose to increase bond by means of 60 grit sandpaper, sanding sponge, or a metal brush.

Step 3

Next, apply a generous bead of a molding adhesive* along the entire inside corner. Reveal edge of plank may show when Stair Nose is installed. To compensate, apply a little more adhesive to the molding.

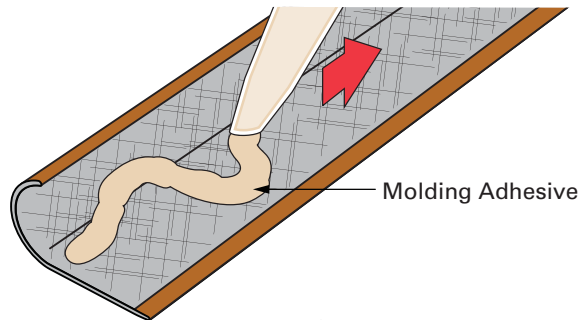

Underside of molding generously covered with molding adhesive

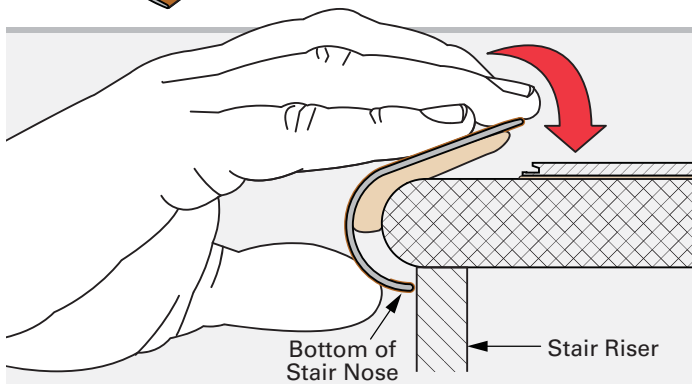
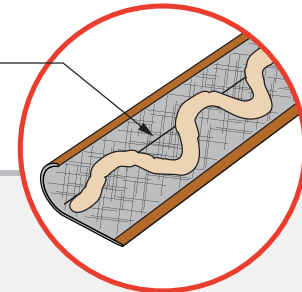

Step 4

Touch the bottom of molding to the stair riser and carefully roll the Stair Nose in place. Make any final adjustments before you push the molding all the way down. Once it's in the final position, press down firmly with your hands and make your way down the entire stair nose. It may take 2 or 3 passes to set it firmly in place.

Step 5

Allow at least 24 hours for the molding adhesive to form a bond. You should always start at top of stairs and work your way down to avoid contact with the installed moldings until cured.

NOTE: Complete cure takes 48-72 hours.

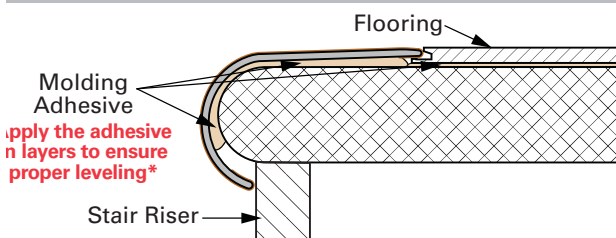

* Premium Polyurethane Construction Adhesive

QUARTER ROUND

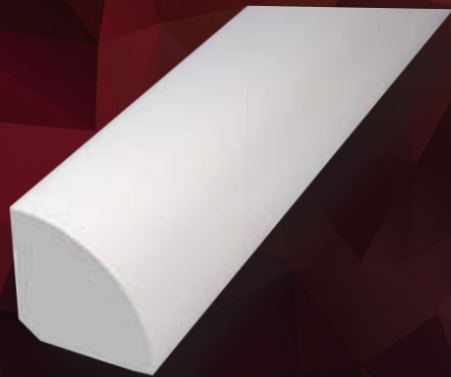

Conceals the expansion space between the wall and the flooring.

Quarter Round

Note: Available for both Rigid Click and Flexible Glue Down Platforms.

Technical Information — Sizes

Quarter Round

Quarter Rounds are used to conceal the required expansion space between the wall and the LVF. **Available as Standard or Moisture Resistant.**

Surface Material: Decorative Paper

Core Material:

Standard Quarter Round: Standard MDF.

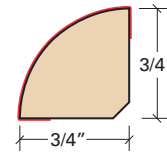

Installation

Quarter Round

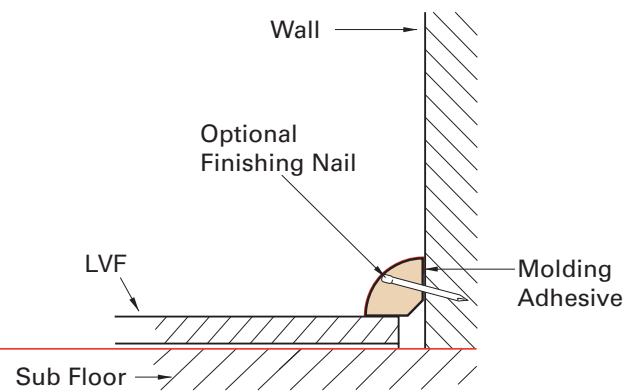

Quarter Round with Existing Wall Base

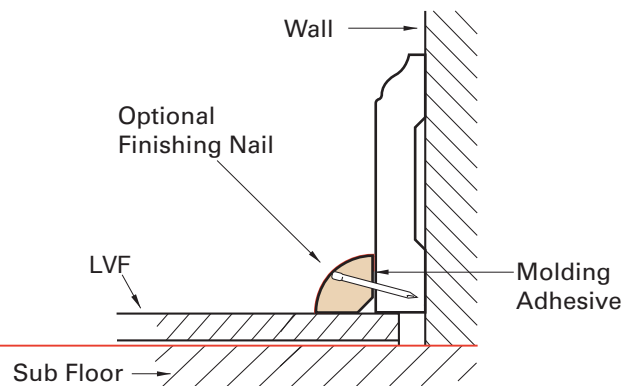

Quarter Round to an Existing Base Molding

Apply one thin bead of molding adhesive* to the back of the Quarter Round and attach it to the existing base molding. Support it with a heavy object until the adhesive has cured so it won't pop off the wall (about 24 hours).

Step 1

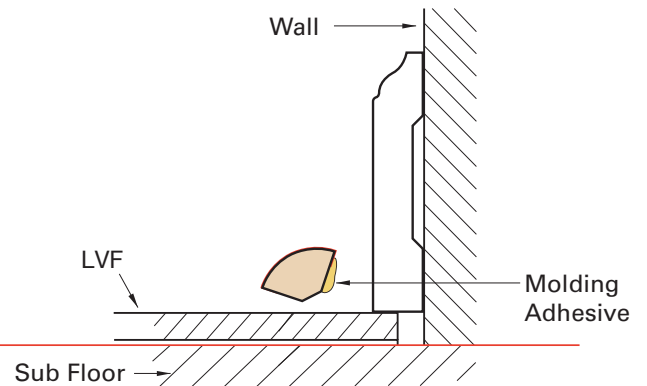

Optional Step: Use finishing nails in the Quarter Round every 16 inches. Finish up the nails with a color matching Color Fill!

Step 2

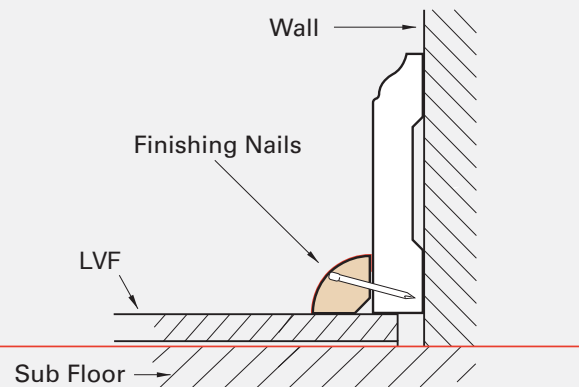

Quarter Round

Leave a gap between the wall and the floor as suggested by the manufacturer of the floor, but no more than 1/2" to allow the molding to sit on the floor!

Step 1

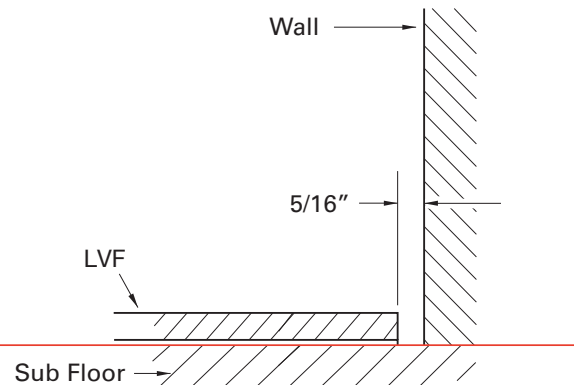

Apply one thin bead of molding adhesive* to the back of the Quarter Round and attach it to the wall. Support it with a heavy object until the adhesive has cured so it won't pop off the wall (about 24 hours).

Step 2

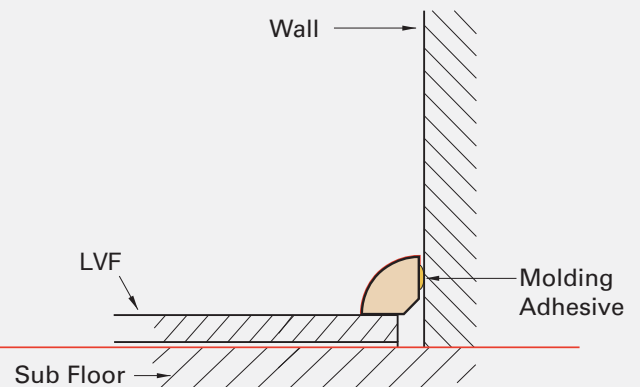

Optional Step: Use finishing nails in the Quarter Round every 16 inches. Finish up the nails with a color matching Color Fill!

Step 3

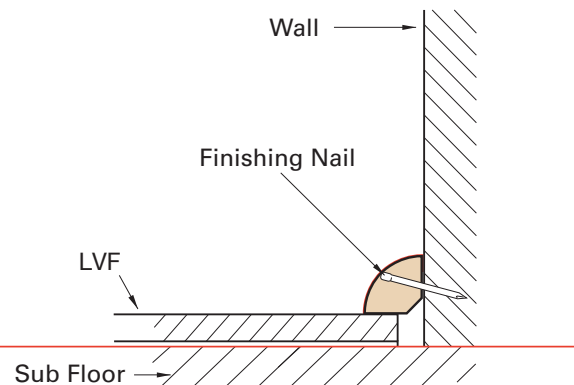

SLIM CAP



Low profile end cap used to transition from flooring to carpet, masonry, sliding doors, and other exterior door jambs.

Slim Cap

Note: Available for both Rigid Click and Flexible Glue Down Platforms.

Technical Information — Sizes

Slim Cap

Slim Cap is used to transition from vinyl to carpet, masonry (fireplaces), sliding doors and other exterior door jambs.

Surface Material: High Wear Resistant Aluminum Oxide Laminate

Core Material: PVC

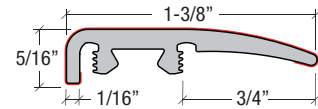

Track

To be used with Slim Cap for floors up to 4.5mm thickness including underlayment. Also, used in conjunction with 1 Versatrack Shim for 5-9.5mm floors including underlayment and 2 shims for 10-12.7mm floors including underlayment.

Material: Cold Roll Steel

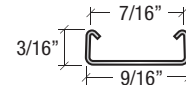

Shim

Slim Cap in conjunction with the SlimTrack or Versatrack for floors from 5mm-12.7mm thickness including underlayment.

Material: Standard HDF

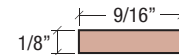

Installation*

FLOOR THICKNESS:	The overall flooring assembly thickness refers to the total thickness of all members of the floor installation being laid upon the subfloor. This typically is comprised of the flooring plank, the underlayment, either attached or loose lay and any additional vapor barriers.
Track Floors Up to 3/16" (0 - 4.5 mm)**	
Track & Shim Floors 3/16 - 3/8 (4.5 - 9.5 mm)**	

*The installation instructions shown on this page are suggestions of how to install our moldings. Daltile does not assume responsibility for any product failure or liability due to installations that are in violation of the flooring manufacturer's installation guidelines and/or warranties.

**All references to flooring thickness refer to the total thickness of all members of the floor installation being laid upon the subfloor. This typically is comprised of the flooring plank, e.g. Vinyl, the underlayment, either attached or loose lay and any additional vapor barriers.

Slim Cap

Floors Up to 3/16" (0 - 4.5 mm)

 Track

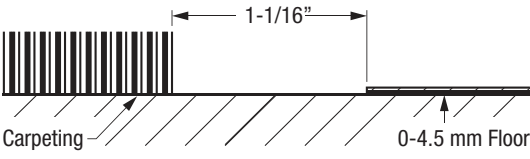
1 

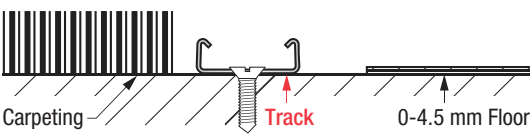
2 

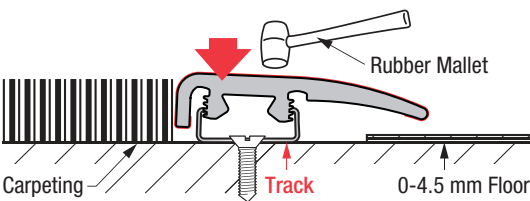
3 

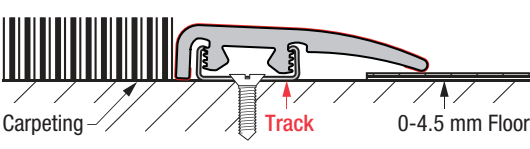
4 

If the flooring manufacturer suggests/permits the use of underlayments, you may need to shim the track to accommodate the increase in overall thickness

Step 1: Install the flooring planks including the underlayment by leaving a 1-1/16" inch (27mm) gap for the installation of the SlimCap molding.

Step 2: Place the Track between the carpet and the flooring. Use the molding for a guide. Screw it to the subfloor by using #6x5/8" screws.

Step 3: Line the SlimCap up with the track and fit one end into the molding. Using a rubber mallet, tap the molding until it engages with the track. **Use your hand to guide the molding into the track as you work your way down**, tapping it in, similar to how you would close a zip-loc bag.

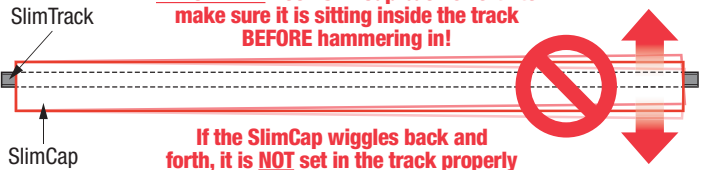



IMPORTANT: Rock SlimCap back & forth to make sure it is sitting inside the track BEFORE hammering in!

If the SlimCap wiggles back and forth, it is NOT set in the track properly and will be damaged when hammered in!

Step 4: Next, go up and down the molding several times, tapping the SlimCap all the way into the track. You can use a little more force once you are sure it is properly engaged in the track.

Floors 3/16 - 3/8 (4.5 - 9.5 mm)

 Track

 Track Shim

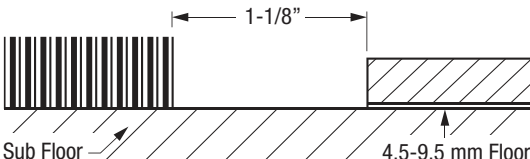
1 

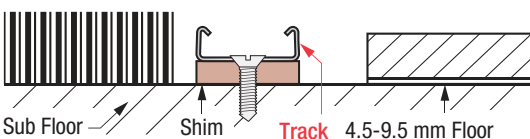
2 

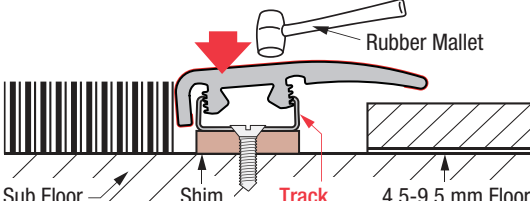
3 

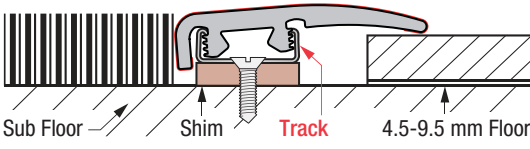
4 

Step 1: Install the flooring planks including the underlayment by leaving a 1-1/16" inch (27mm) gap for the installation of the SlimCap molding.

Step 2: Place the Track and shim between the carpet and the flooring. Use the molding for a guide. Screw them to the subfloor by using #6x5/8" screws.

Step 3: Line the SlimCap up with the track and fit one end into the molding. Using a rubber mallet, tap the molding until it engages with the track. **Use your hand to guide the molding into the track as you work your way down**, tapping it in, similar to how you would close a zip-loc bag.

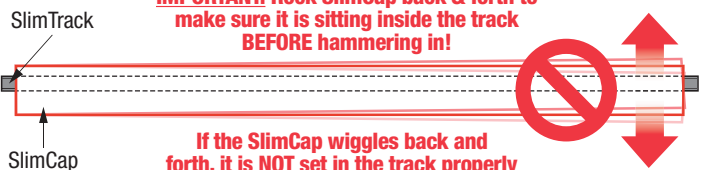

IMPORTANT: Rock SlimCap back & forth to make sure it is sitting inside the track BEFORE hammering in!

If the SlimCap wiggles back and forth, it is NOT set in the track properly and will be damaged when hammered in!

Step 4: Next, go up and down the molding several times, tapping the SlimCap all the way into the track. You can use a little more force once you are sure it is properly engaged in the track.