



# CORE FUNDAMENTALS™

CHOICE | ADVANTAGE | PRIME | PLATINUM





CORE FUNDAMENTALS™

CHOICE



ADVANTAGE



PRIME



PLATINUM



STONE  
LOOK

USAGE



FLOOR



WALL



COUNTERTOP



SHOWER  
FLOOR



EXTERIOR  
FLOOR



STEPWISE™



TRU-EDGE™



MADE IN  
THE U.S.A.



LARGE  
FORMAT



MOSAIC/  
DECO



ENCAUSTIC



TERRAZZO



PAVER



CUSTOMIZE



FLEXFIT™



CG  
SLIP  
GRADE



SPECIAL FEATURES



# CORE FUNDAMENTALS™ CHOICE

THE **CHOICE TIER** HIGHLIGHTS THE BASICS WITH A VARIETY OF FLOOR TILE AND MOSAICS EXCELLENT FOR EVERYDAY USE.



NOT APPLICABLE  
FOR ALL PRODUCTS  
IN THIS SERIES. SEE CHARTS  
FOR FULL PRODUCT DETAILS.

# CORE FUNDAMENTALS™ – CHOICE

## GLAZED CERAMIC FLOOR & MOSAICS

STONE LOOK FINISHES: MATTE

### FLOOR TILE



WEATHERED WHITE SQ20



BURROW BEIGE SQ21



SHADOW GREY SQ22

### 2 x 2 MOSAIC



WEATHERED WHITE SQ20



BURROW BEIGE SQ21



SHADOW GREY SQ22

### AVAILABLE TILE SIZES



18 x 18  
Floor Tile



12 x 24  
Floor Tile



12 x 12  
Floor Tile



2 x 2  
Mosaic

STONE LOOK FINISHES: MATTE

### FLOOR TILE

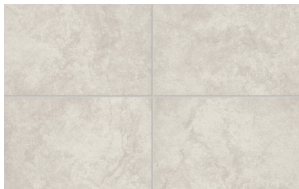

IVORY AR04



CASPER AR05



FAWN AR02

### AVAILABLE TILE SIZES



15 x 15  
Floor Tile



12 x 24  
Floor Tile



12 x 12  
Floor Tile

STONE LOOK FINISHES: MATTE

### FLOOR TILE



FAIR CS22



BUFF CS20

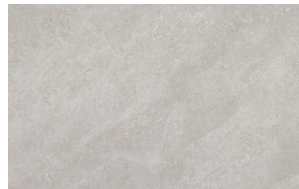

IRON CS23

### 2 x 2 MOSAIC

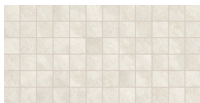

FAIR CS22

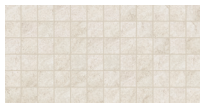

BUFF CS20

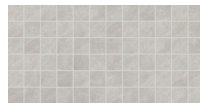

IRON CS23

### AVAILABLE TILE SIZES



18 x 18  
Floor Tile



12 x 24  
Floor Tile



12 x 12  
Floor Tile



2 x 2  
Mosaic

STONE LOOK FINISHES: MATTE

### FLOOR TILE

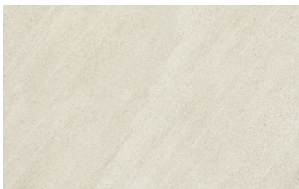

EVEREST WHITE CG05

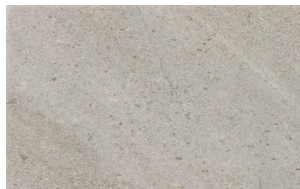

TWILIGHT GREY CG07



CALM BEIGE CG08

### 2 x 2 MOSAIC



EVEREST WHITE CG05



TWILIGHT GREY CG07

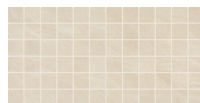

CALM BEIGE CG08

### AVAILABLE TILE SIZES



18 x 18  
Floor Tile



12 x 24  
Floor Tile



12 x 12  
Floor Tile



2 x 2  
Mosaic







FOR COMPLETE PRODUCT INFORMATION, PLEASE VISIT [WWW.DAL TILE/CORE-FUNDAMENTALS](http://WWW.DAL TILE/CORE-FUNDAMENTALS)

# CORE FUNDAMENTALS™ – CHOICE

AVAILABLE SIZE & TRIM SHAPES

## CHOICE

PLEASE REFER TO THE CHART BELOW FOR AVAILABILITY BASED ON COLOR CODE

FLOOR			THICKNESS	FLOOR TRIM		
	<b>18 x 18 Floor Tile</b>	17-11/16" x 17-11/16" (45.01 cm x 45.01 cm)	5/16"		<b>P43C9</b>	3 x 12 Floor Bullnose
	<b>15 x 15 Floor Tile</b>	14-5/8" x 14-5/8" (37.30 cm x 37.30 cm)	5/16"			
	<b>12 x 24 Floor Tile</b>	11-13/16" x 23-11/16" (30.02 cm x 60.12 cm)	5/16"			
	<b>12 x 12 Floor Tile</b>	11-13/16" x 11-13/16" (30.02 cm x 30.02 cm)	5/16"			
MOSAICS			THICKNESS			
	<b>2 x 2 Mosaic Dot-mounted</b>	(12" x 24" Sheet) (30.48 cm x 60.96 cm Sheet)	1/4"			

COLOR #	COLOR NAME	PAGE #	FLOOR				MOSAIC	
			FIELD TILE					BULLNOSE
			18 x 18	15 x 15	12 x 24	12 x 12		P43C9
AR02	Fawn	5		●	●	●		
AR04	Ivory	5		●	●	●		
AR05	Casper	5		●	●	●		
CG05	Everest White	5	●		●	●		
CG07	Twilight Grey	5	●		●	●		
CS20	Buff	5	●		●	●	●	
CS22	Fair	5	●		●	●	●	
CS23	Iron	5	●		●	●	●	
SQ20	Weathered White	5	●		●	●	●	
SQ21	Burrow Beige	5	●		●	●	●	
SQ22	Shadow Grey	5	●		●	●	●	

# CORE FUNDAMENTALS™ – CHOICE

## APPLICATION SPECIFICATIONS

### CHOICE – AR02 | AR04 | AR05 | SQ20 | SQ21 | SQ22 | CG05 | CG07

#### APPLICATIONS

	Target DCOF wet	Suitable
Dry & Level – Interior Floor	N/A	✓
Wet & Level – Interior Floor	≥ 0.42	✓
Shower Floor – Standard Center Drain	≥ 0.42	✓*
Shower Floor – Linear Drain	≥ 0.42	✓*
Exterior Floor Applications (including patios, pool decking & other wet areas with minimal footwear)	≥ 0.60	
Ramps & Inclines	≥ 0.65	
Walls/Backsplashes	N/A	✓
Countertops	N/A	✓
Pool Linings	N/A	✓*



A DCOF value of ≥0.42 is the standard for tiles specified for level interior spaces expected to be walked upon when wet, as stated in ANSI A137.1-A326.3. For more information about DCOF and the DCOF AcuTest™, visit [daltile.com/DCOF](http://daltile.com/DCOF).

#### APPLICATION NOTES:

Suitable for exterior applications (provided it is noted as suitable in the applications chart above) in non-freezing climates, when proper installation methods are followed.

\* Mosaic tile only.

#### INSTALLATION

Grout Joint Recommendation	Shade Variation
<b>Floor:</b> 3/16" (Overlap should not exceed 33% when installing tile with a length 15" or greater in a staggered brick-joint pattern.)	 Medium (V2) SQ20, SQ21 & SQ22
<b>Mosaic:</b> 1/8"	 High (V3) AR02, AR04, AR05, CG05 & CG07

#### PERFORMANCE CHARACTERISTICS

	ASTM#	Result
Water Absorption	C373	< 7.0%
Breaking Strength	C648	> 250 lbf
Scratch Hardness	C1895	8.0
Chemical Resistance	C650	Resistant

For additional information on test results, visit us at: [daltile.com/information/TestResults](http://daltile.com/information/TestResults).

#### DURABILITY

##### Floor Surface Wear Resistance

1 Residential Bathrooms	③	All Residential / Light Commercial
2 All Residential Areas	4	All Residential / Commercial

### CHOICE – CS20 | CS22 | CS23

#### APPLICATIONS

	Target DCOF wet	Suitable
Dry & Level – Interior Floor	N/A	✓
Wet & Level – Interior Floor	≥ 0.42	✓
Shower Floor – Standard Center Drain	≥ 0.42	✓*
Shower Floor – Linear Drain	≥ 0.42	✓*
Exterior Floor Applications (including patios, pool decking & other wet areas with minimal footwear)	≥ 0.60	
Ramps & Inclines	≥ 0.65	
Walls/Backsplashes	N/A	✓
Countertops	N/A	✓
Pool Linings	N/A	✓*

A DCOF value of ≥0.42 is the standard for tiles specified for level interior spaces expected to be walked upon when wet, as stated in ANSI A137.1-A326.3. For more information about DCOF and the DCOF AcuTest™, visit [daltile.com/DCOF](http://daltile.com/DCOF).

#### APPLICATION NOTES:

Suitable for exterior applications (provided it is noted as suitable in the applications chart above) in non-freezing climates, when proper installation methods are followed.

\* Mosaic tile only.

#### INSTALLATION

Grout Joint Recommendation	Shade Variation
<b>Floor:</b> 3/16" (Overlap should not exceed 33% when installing tile with a length 15" or greater in a staggered brick-joint pattern.)	 Medium (V2)
<b>Mosaic:</b> 1/8"	

#### PERFORMANCE CHARACTERISTICS

	ASTM#	Floor Result	Mosaic Result
Water Absorption	C373	< 7.0%	< 3.0%
Breaking Strength	C648	> 250 lbf	> 250 lbf
Scratch Hardness	C1895	7.0	7.0
Chemical Resistance	C650	Resistant	Resistant

For additional information on test results, visit us at: [daltile.com/information/TestResults](http://daltile.com/information/TestResults).

#### DURABILITY

##### Floor Surface Wear Resistance

1 Residential Bathrooms	③	All Residential / Light Commercial
2 All Residential Areas	4	All Residential / Commercial

STONE  
LOOK

USAGE



FLOOR



WALL



COUNTERTOP



SHOWER  
FLOOR



EXTERIOR  
FLOOR



STEPWISE™



TRU-EDGE™



MADE IN  
THE U.S.A.



LARGE  
FORMAT



MOSAIC/  
DECO



ENCAUSTIC



TERRAZZO



PAVER



CUSTOMIZE



FLEXFIT™



CG  
SLIP  
GRADE

LOW HIGH

SPECIAL FEATURES



# CORE FUNDAMENTALS™ ADVANTAGE

THE **ADVANTAGE TIER** IS RICH WITH A COMBINATION OF DIFFERENT FLOOR, WALL, AND MOSAICS TO EXCITE DESIGN, TO MIX AND MATCH OR CREATE A COHESIVE LOOK.



NOT APPLICABLE  
FOR ALL PRODUCTS  
IN THIS SERIES. SEE CHARTS  
FOR FULL PRODUCT DETAILS.

# CORE FUNDAMENTALS™ – ADVANTAGE

GLAZED CERAMIC FLOOR, WALL & MOSAICS

**STONE LOOK** FINISHES: MATTE

## FLOOR TILE



WASHED WHITE LS40



DISTRESSED BEIGE LS41



AGED GREY LS42

## 2 x 4 BRICK-JOINT MOSAIC



WASHED WHITE LS40



DISTRESSED BEIGE LS41



AGED GREY LS42

### AVAILABLE TILE SIZES



18 x 18  
Floor Tile



12 x 24  
Floor Tile



12 x 12  
Floor Tile



2 x 4 Brick-joint  
Mosaic

**STONE LOOK** FINISHES: MATTE & SATIN

## FLOOR TILE



PORTRAIT WHITE AQ01



MURAL TAUPE AQ02



RENOIR GREY AQ03

## 2 x 4 BRICK-JOINT MOSAIC



PORTRAIT WHITE AQ01



MURAL TAUPE AQ02



RENOIR GREY AQ03

### AVAILABLE TILE SIZES



18 x 18  
Floor Tile



12 x 24  
Floor Tile



12 x 12  
Floor Tile



10 x 14  
Wall Tile\*



2 x 4 Brick-joint  
Mosaic

\*10 x 14 available in AQ02 & AQ03 only.

# CORE FUNDAMENTALS™ – ADVANTAGE

GLAZED CERAMIC FLOOR, WALL & MOSAICS

**STONE LOOK** FINISHES: MATTE

## FLOOR TILE



ARIA WHITE EP20



PERCUSSION TAUPE EP21



TRUMPET GREY EP22

## 2 x 4 HERRINGBONE MOSAIC



ARIA WHITE EP20



PERCUSSION TAUPE EP21



TRUMPET GREY EP22

### AVAILABLE TILE SIZES



18 x 18  
Floor Tile



12 x 24  
Floor Tile



12 x 12  
Floor Tile



2 x 4  
Herringbone Mosaic

**CONCRETE LOOK** FINISHES: MATTE

## FLOOR TILE



WHITE CANVAS SV16



GOLDEN SAND SV17



CEMENT GREY SV18

## 2 x 2 MOSAIC



WHITE CANVAS SV16

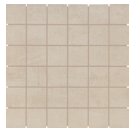

GOLDEN SAND SV17



CEMENT GREY SV18

### AVAILABLE TILE SIZES



18 x 18  
Floor Tile



12 x 24  
Floor Tile













2 x 2  
Mosaic

# CORE FUNDAMENTALS™ – ADVANTAGE

AVAILABLE SIZE & TRIM SHAPES

## ADVANTAGE

PLEASE REFER TO THE CHART BELOW FOR AVAILABILITY BASED ON COLOR CODE

FLOOR			THICKNESS			FLOOR TRIM		
	<b>18 x 18 Floor Tile</b>	17-11/16" x 17-11/16" (45.01 cm x 45.01 cm)	5/16"				<b>P43C9</b>	3 x 12 Floor Bullnose
	<b>12 x 24 Floor Tile</b>	11-13/16" x 23-11/16" (30.02 cm x 60.12 cm)	5/16"			<b>WALL TRIM</b>		
	<b>12 x 12 Floor Tile</b>	11-13/16" x 11-13/16" (30.02 cm x 30.02 cm)	5/16"				<b>S4310</b>	3 x 10 Wall Bullnose
WALL			THICKNESS				<b>SN4310</b>	3 x 3 Wall Bullnose Corner
	<b>10 x 14 Wall Tile</b>	9-13/16" x 13-15/16" (24.99 cm x 35.40 cm)	5/16"					
MOSAICS			THICKNESS					
	<b>2 x 4 Brick-joint Mosaic Dot-mounted</b>	12" x 12" Sheet (30.48 cm x 30.48 cm Sheet)	1/4"					
	<b>2 x 4 Herringbone Mosaic Dot-mounted</b>	14" x 12" Sheet (35.56 cm x 30.48 cm Sheet)	1/4"					
	<b>2 x 2 Mosaic Dot-mounted</b>	12" x 12" Sheet (30.48 cm x 30.48 cm Sheet)	1/4"					

## ADVANTAGE

COLOR #	COLOR NAME	PAGE #	FLOOR				WALL		MOSAIC		
			FIELD TILE			BULLNOSE	FIELD TILE	BULLNOSE	2 x 4 BRICK-JOINT	2 x 4 HERRINGBONE	2 x 2
			18 x 18	12 x 24	12 x 12	P43C9	10 X 14 AQ SATIN FINISH SV MATTE FINISH	S4310 SN4310			
AQ01	Portrait White	09	●	●	●	●			●		
AQ02	Mural Taupe	09	●	●	●	●	●	●	●	●	
AQ03	Renoir Grey	09	●	●	●	●	●	●	●		
EP20	Aria White	10	●	●	●	●				●	
EP21	Percussion Taupe	10	●	●	●	●				●	
EP22	Trumpet Grey	10	●	●	●	●				●	
LS40	Washed White	09	●	●	●	●			●		
LS41	Distressed Beige	09	●	●	●	●			●		
LS42	Aged Grey	09	●	●	●	●			●		
SV16	White Canvas	10	●	●		●					●
SV17	Golden Sand	10	●	●		●					●
SV18	Cement Grey	10	●	●		●					●

# CORE FUNDAMENTALS™ – ADVANTAGE

## APPLICATION SPECIFICATIONS

ADVANTAGE: AQ01 | AQ02 | AQ03 | EP20 | EP21 | EP22 | LS40 | LS41 | LS42 | SV16 | SV17 | SV18

### APPLICATIONS

	Target DCOF wet	Suitable
Dry & Level – Interior Floor	N/A	✓**
Wet & Level – Interior Floor	≥ 0.42	✓**
Shower Floor – Standard Center Drain	≥ 0.42	✓*
Shower Floor – Linear Drain	≥ 0.42	✓*
Exterior Floor Applications (including patios, pool decking & other wet areas with minimal footwear)	≥ 0.60	
Ramps & Inclines	≥ 0.65	
Walls/Backsplashes	N/A	✓
Countertops	N/A	✓**
Pool Linings	N/A	✓*

A DCOF value of ≥0.42 is the standard for tiles specified for level interior spaces expected to be walked upon when wet, as stated in ANSI A137.1-A326.3. For more information about DCOF and the DCOF AcuTest™, visit [daltille.com/DCOF](http://daltille.com/DCOF).



#### APPLICATION NOTES:

Suitable for exterior applications (provided it is noted as suitable in the applications chart above) in non-freezing climates, when proper installation methods are followed. Wall tile suitable for walls/backsplashes only.

\*\* Wall tile not suitable for application

\* Mosaic tile only

### INSTALLATION

Grout Joint Recommendation	Shade Variation
<b>Floor:</b> 3/16" (Overlap should not exceed 33% when installing tile with a length 15" or greater in a staggered brick-joint pattern.)	 Medium (V2) SV16, SV17 & SV18
<b>Mosaic:</b> 1/8"	 High (V3) AQ01, AQ02, AQ03, EP20, EP21, EP22, LS40, LS41 & LS42
<b>Wall:</b> 1/16"	

### PERFORMANCE CHARACTERISTICS

	ASTM#	Floor Result	Wall Result	Mosaic Result
Water Absorption	C373	< 7.0%	< 20.0%	< 3.0%
Breaking Strength	C648	> 250 lbf	120-230 lbf	> 250 lbf
Scratch Hardness	C1895	7.0	4.0-6.0	8.0
Chemical Resistance	C650	Resistant	Resistant	Resistant

For additional information on test results, visit us at: [daltille.com/information/TestResults](http://daltille.com/information/TestResults).

### DURABILITY

Floor Surface Wear Resistance				
1	Residential Bathrooms	③	All Residential / Light Commercial	
2	All Residential Areas	4	All Residential / Commercial	



STONE  
LOOK

USAGE



COUNTERTOP

SHOWER FLOOR

EXTERIOR FLOOR

STEPWISE™

TRU-EDGE™

MADE IN THE U.S.A.

LARGE FORMAT

MOSAIC/DECO

ENCAUSTIC

TERRAZZO

PAVER

CUSTOMIZE

FLEXFIT™

LOW HIGH

SPECIAL FEATURES

# CORE FUNDAMENTALS™ PRIME

THE **PRIME TIER** PROVIDES ALL THE ESSENTIAL BENEFITS OF TILE WHILE OFFERING AN ARRAY OF DIFFERENT LOOKS AND DECORATIVE ACCENTS TO HEIGHTEN DESIGN.

NOT APPLICABLE FOR ALL PRODUCTS IN THIS SERIES. SEE CHARTS FOR FULL PRODUCT DETAILS.

# CORE FUNDAMENTALS™ – PRIME

## GLAZED CERAMIC FLOOR, WALL & MOSAICS

**STONE LOOK** FINISHES: MATTE & GLOSSY

### FLOOR TILE



HEIRLOOM WHITE NS10



LINEAGE GREIGE NS11



HISTORIC GREY NS12

### 1 x 3 HERRINGBONE MOSAIC



HEIRLOOM WHITE NS10



LINEAGE GREIGE NS11

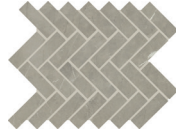

HISTORIC GREY NS12

### AVAILABLE TILE SIZES



18 x 18  
Floor Tile



12 x 24  
Floor Tile



8 x 24  
Wall Tile



1 x 3 Herringbone  
Mosaic

**STONE LOOK** FINISHES: MATTE

### FLOOR TILE



WHITE BA30

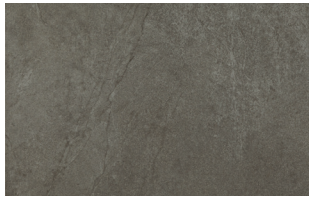

CHARCOAL BA34

### 2 x 4 MOSAIC



WHITE BA30

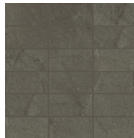

CHARCOAL BA34

### AVAILABLE TILE SIZES



18 x 18  
Floor Tile



12 x 24  
Floor Tile



12 x 12  
Floor Tile



10 x 14  
Wall Tile



2 x 4 Straight-joint  
Mosaic

**MONOCHROMATIC LOOK** FINISHES: MATTE

### FLOOR TILE

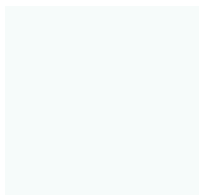

RAINIER 1500

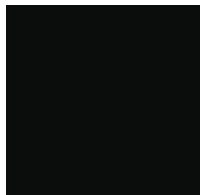

BLACK 2011

### AVAILABLE TILE SIZES



12 x 12  
Floor Tile

# CORE FUNDAMENTALS™ – PRIME

GLAZED CERAMIC FLOOR, WALL & MOSAICS

**STONE LOOK** FINISHES: MATTE

## FLOOR TILE



WHITE EL30



BEIGE EL31

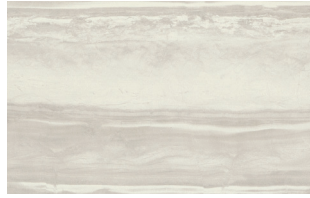

GREY EL32

## 1 x 3 HERRINGBONE MOSAIC



WHITE EL30



BEIGE EL31



GREY EL32

### AVAILABLE TILE SIZES



12 x 24  
Floor Tile



4 x 12  
Wall Tile



1 x 3  
Herringbone Mosaic

**CONCRETE LOOK** FINISHES: MATTE

## FLOOR TILE

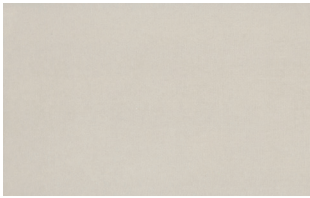

WHITE KC01

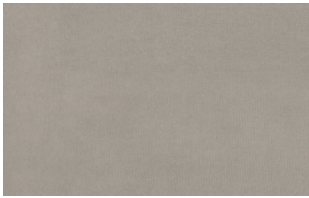

GREY KC04

## 2 x 2 MOSAIC

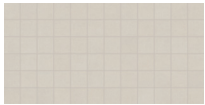

WHITE KC01



GREY KC04

### AVAILABLE TILE SIZES



18 x 18  
Floor Tile



12 x 24  
Floor Tile



12 x 12  
Floor Tile



2 x 2  
Mosaic

**STONE LOOK** FINISHES: MATTE

## FLOOR TILE



VITALITY WHITE RL20

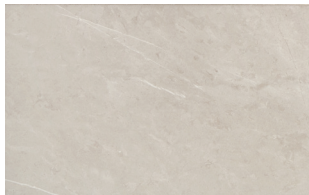

DYNAMIC BEIGE RL21



STAMINA GREY RL23

## 1.5" HEX MOSAIC



VITALITY WHITE  
RL20



DYNAMIC BEIGE  
RL21



STAMINA GREY  
RL23

### AVAILABLE TILE SIZES



12 x 24  
Floor Tile



12 x 12  
Floor Tile





1.5" Hex  
Mosaic



# CORE FUNDAMENTALS™ – PRIME





AVAILABLE SIZE & TRIM SHAPES



## PRIME



PLEASE REFER TO THE CHART BELOW FOR AVAILABILITY BASED ON COLOR CODE

FLOOR	SIZES	THICKNESS
	<b>18 x 18 Floor Tile</b> 17-11/16" x 17-11/16" (45.01 cm x 45.01 cm)	5/16"
	<b>12 x 24 Floor Tile</b> 11-13/16" x 23-11/16" (30.02 cm x 60.12 cm)	5/16"
	<b>12 x 12 Floor Tile</b> 11-13/16" x 11-13/16" (30.02 cm x 30.02 cm)	5/16"

WALL	SIZES	THICKNESS
	<b>8 x 24 Wall Tile</b> 8" x 24" (20.34 cm x 61.30 cm)	3/8"
	<b>10 x 14 Wall Tile</b> 9-13/16" x 13-15/16" (24.99 cm x 35.43 cm)	5/16"
	<b>4 x 12 Wall Tile</b> 4-1/4" x 12-7/8" (10.88 cm x 32.76 cm)	5/16"

MOSAICS	SIZES	THICKNESS
	<b>2 x 4 Straight-joint Mosaic Dot-mounted</b> 12" x 12" Sheet (30.48 x 30.48 cm Sheet)	1/4"
	<b>2 x 2 Mosaic Dot-mounted</b> 12" x 24" Sheet (30.48 cm x 60.96 cm Sheet)	1/4"
	<b>1.5" Hex Mosaic Dot-mounted</b> 11-3/8" x 10-1/4" Sheet (28.89 cm x 26.04 cm Sheet)	1/4"
	<b>1 x 3 Herringbone Mosaic Dot-mounted</b> 9" x 12" Sheet (22.86 x 30.48 cm Sheet)	1/4"

FLOOR TRIM		
	<b>P43F9</b>	3 x 24 Floor Bullnose
	<b>P43C9</b>	3 x 12 Floor Bullnose

WALL TRIM		
	<b>S1/212J</b>	12" Jolly
	<b>S4310</b>	3 x 10 Wall Bullnose
	<b>SN4310</b>	3 x 3 Wall Bullnose Corner

COLOR #	COLOR NAME	PAGE #	FLOOR					WALL					MOSAIC			
			FIELD TILE			BULLNOSE		FIELD TILE			BULLNOSE		2 x 4 STRAIGHT-JOINT	2 x 2	1.5 HEXAGON	1 x 3 HERRINGBONE
			18 x 18	12 x 24	12 x 12	P43F9	P43C9	10 x 14 Matte	8 x 24 Glossy	4 x 12 Matte	S4310 SN4310	S1/212J				
BA30	White	15	●	●	●		●	●			●		●			
BA34	Charcoal	15	●	●	●		●	●			●		●			
EL30	White	16		●		●				●		●				●
EL31	Beige	16		●		●				●		●				●
EL32	Grey	16		●		●				●		●				●
KC01	White	16	●	●	●		●							●		
KC04	Grey	16	●	●	●		●							●		
NS10	Heirloom White	15	●	●			●		●		●					●
NS11	Lineage Greige	15	●	●			●		●		●					●
NS12	Historic Grey	15	●	●			●		●		●					●
RL20	Vitality White	16		●	●	●									●	
RL21	Dynamic Beige	16		●	●	●									●	
RL23	Stamina Grey	16		●	●	●									●	
1500	Rainier	15			●											
2011	Black	15			●											

# CORE FUNDAMENTALS™ – PRIME

## APPLICATION SPECIFICATIONS

**PRIME: BA30 | BA34 | KC01 | KC04 | NS10 | NS11 | NS12**

### APPLICATIONS

	Target DCOF wet	Suitable
Dry & Level – Interior Floor	N/A	✓**
Wet & Level – Interior Floor	≥ 0.42	✓**
Shower Floor – Standard Center Drain	≥ 0.42	✓*
Shower Floor – Linear Drain	≥ 0.42	✓*
Exterior Floor Applications (including patios, pool decking & other wet areas with minimal footwear)	≥ 0.60	
Ramps & Inclines	≥ 0.65	
Walls/Backsplashes	N/A	✓
Countertops	N/A	✓**
Pool Linings	N/A	✓*

A DCOF value of ≥0.42 is the standard for tiles specified for level interior spaces expected to be walked upon when wet, as stated in ANSI A137.1-A326.3. For more information about DCOF and the DCOF AcuTest™, visit [daltile.com/DCOF](http://daltile.com/DCOF).



#### APPLICATION NOTES:

Suitable for exterior applications (provided it is noted as suitable in the applications chart above) in non-freezing climates, when proper installation methods are followed.

\*\* Wall tile not suitable for this application

\* Mosaic tile only

### INSTALLATION

Grout Joint Recommendation	Shade Variation
<b>Floor:</b> 3/16" (Overlap should not exceed 33% when installing tile with a length 15" or greater in a staggered brick-joint pattern.)	 Medium (V2) NS10, NS11 & NS12
<b>Wall:</b> 1/16"	 High (V3) BA30, BA34, KC01 & KC04
<b>Mosaic:</b> 1/8"	

### PERFORMANCE CHARACTERISTICS

	ASTM#	Floor Result	Wall Result	Mosaic Result
Water Absorption	C373	< 7.0%	< 20.0%	< 3.0%
Breaking Strength	C648	> 250 lbf	120-230 lbf	> 250 lbf
Scratch Hardness	C1895	7.0	4.0-6.0	7.0
Chemical Resistance	C650	Resistant	Resistant	Resistant

For additional information on test results, visit us at: [daltile.com/information/TestResults](http://daltile.com/information/TestResults).

### DURABILITY

#### Floor Surface Wear Resistance

1 Residential Bathrooms (3)	All Residential / Light Commercial
2 All Residential Areas	4 All Residential / Commercial

**PRIME: EL30 | EL31 | EL32**

### APPLICATIONS

	Target DCOF wet	Suitable
Dry & Level – Interior Floor	N/A	✓**
Wet & Level – Interior Floor	≥ 0.42	✓**
Shower Floor – Standard Center Drain	≥ 0.42	✓*
Shower Floor – Linear Drain	≥ 0.42	✓*
Exterior Floor Applications (including patios, pool decking & other wet areas with minimal footwear)	≥ 0.60	
Ramps & Inclines	≥ 0.65	
Walls/Backsplashes	N/A	✓
Countertops	N/A	✓**
Pool Linings	N/A	✓*

A DCOF value of ≥0.42 is the standard for tiles specified for level interior spaces expected to be walked upon when wet, as stated in ANSI A137.1-A326.3. For more information about DCOF and the DCOF AcuTest™, visit [daltile.com/DCOF](http://daltile.com/DCOF).

#### APPLICATION NOTES:

Suitable for exterior applications (provided it is noted as suitable in the applications chart above) in non-freezing climates, when proper installation methods are followed.

\*\* Wall tile not suitable for this application

\* Mosaic tile only

### INSTALLATION

Grout Joint Recommendation	Shade Variation
<b>Floor:</b> 3/16" (Overlap should not exceed 33% when installing tile with a length 15" or greater in a staggered brick-joint pattern.)	 High (V3)
<b>Wall:</b> 1/16" (When rectangular size is installed in a staggered brick-joint pattern, overlap should not exceed 33%)	
<b>Mosaic:</b> 1/8"	

### PERFORMANCE CHARACTERISTICS

	ASTM#	Floor Result	Wall Result	Mosaic Result
Water Absorption	C373	< 7.0%	< 20.0%	< 3.0%
Breaking Strength	C648	> 250 lbf	120-230 lbf	> 250 lbf
Scratch Hardness	C1895	8.0	4.0-6.0	7.0
Chemical Resistance	C650	Resistant	Resistant	Resistant

For additional information on test results, visit us at: [daltile.com/information/TestResults](http://daltile.com/information/TestResults).

### DURABILITY

#### Floor Surface Wear Resistance

1 Residential Bathrooms (3)	All Residential / Light Commercial
2 All Residential Areas	4 All Residential / Commercial

# CORE FUNDAMENTALS™ – PRIME

## APPLICATION SPECIFICATIONS

### PRIME: RL20 | RL21 | RL23

#### APPLICATIONS

	Target DCOF wet	Suitable
Dry & Level – Interior Floor	N/A	✓**
Wet & Level – Interior Floor	≥ 0.42	✓**
Shower Floor – Standard Center Drain	≥ 0.42	✓*
Shower Floor – Linear Drain	≥ 0.42	✓*
Exterior Floor Applications (including patios, pool decking & other wet areas with minimal footwear)	≥ 0.60	
Ramps & Inclines	≥ 0.65	
Walls/Backsplashes	N/A	✓
Countertops	N/A	✓**
Pool Linings	N/A	✓*

A DCOF value of ≥0.42 is the standard for tiles specified for level interior spaces expected to be walked upon when wet, as stated in ANSI A137.1-A326.3. For more information about DCOF and the DCOF AcuTest™, visit [daltile.com/DCOF](http://daltile.com/DCOF).

#### APPLICATION NOTES:

Suitable for exterior applications (provided it is noted as suitable in the applications chart above) in non-freezing climates, when proper installation methods are followed.

\*\* Wall tile not suitable for this application

\* Mosaic tile only

#### INSTALLATION

Grout Joint Recommendation	Shade Variation
<b>Floor:</b> 3/16" (Overlap should not exceed 33% when installing tile with a length 15" or greater in a staggered brick-joint pattern.)	
<b>Wall:</b> 10 x 14: 1/16" 4 x 16: 1/16" (When rectangular size is installed in a staggered brick-joint pattern, overlap should not exceed 33%)	 High (V3)
<b>Mosaic:</b> 1/8"	

#### PERFORMANCE CHARACTERISTICS

	ASTM#	Floor Result	Wall Result	Mosaic Result
Water Absorption	C373	< 7.0%	< 20.0%	< 3.0%
Breaking Strength	C648	> 250 lbf	120-230 lbf	> 250 lbf
Scratch Hardness	C1895	8.0	4.0-6.0	8.0
Chemical Resistance	C650	Resistant	Resistant	Resistant

For additional information on test results, visit us at: [daltile.com/information/TestResults](http://daltile.com/information/TestResults).

#### DURABILITY

##### Floor Surface Wear Resistance

1 Residential Bathrooms (3)	All Residential / Light Commercial
2 All Residential Areas	4 All Residential / Commercial

### PRIME: 1500 | 2011

#### APPLICATIONS

	Target DCOF wet	Suitable
Dry & Level – Interior Floor	N/A	✓
Wet & Level – Interior Floor	≥ 0.42	
Shower Floor – Standard Center Drain	≥ 0.42	
Shower Floor – Linear Drain	≥ 0.42	
Exterior Floor Applications (including patios, pool decking & other wet areas with minimal footwear)	≥ 0.60	
Ramps & Inclines	≥ 0.65	
Walls/Backsplashes	N/A	✓
Countertops	N/A	✓
Pool Linings	N/A	

A DCOF value of ≥0.42 is the standard for tiles specified for level interior spaces expected to be walked upon when wet, as stated in ANSI A137.1-A326.3. For more information about DCOF and the DCOF AcuTest™, visit [daltile.com/DCOF](http://daltile.com/DCOF).

#### APPLICATION NOTES:

Suitable for exterior applications (provided it is noted as suitable in the applications chart above) in non-freezing climates, when proper installation methods are followed.

#### INSTALLATION

Grout Joint Recommendation	Shade Variation
3/16"	 Low (V1)

#### PERFORMANCE CHARACTERISTICS

	ASTM#	Result
Water Absorption	C373	< 7.0%
Breaking Strength	C648	> 250 lbf
Scratch Hardness	C1895	7.0
Chemical Resistance	C650	Resistant

For additional information on test results, visit us at: [daltile.com/information/TestResults](http://daltile.com/information/TestResults).

#### DURABILITY

##### Floor Surface Wear Resistance

1 Residential Bathrooms (3)	All Residential / Light Commercial
2 All Residential Areas	4 All Residential / Commercial

STONE  
LOOK

USAGE



FLOOR



WALL



COUNTERTOP



SHOWER  
FLOOR



EXTERIOR  
FLOOR



STEPWISE™



TRU-EDGE™



MADE IN  
THE U.S.A.



LARGE  
FORMAT



MOSAIC/  
DECO



ENCAUSTIC



TERRAZZO



PAVER



CUSTOMIZE



FLEXFIT™



LOW HIGH

SPECIAL FEATURES



# CORE FUNDAMENTALS™ PLATINUM

THE **PLATINUM TIER** OFFERS THE LOOK OF LUXURY, COMBINING MARBLE, WOOD, AND STONE LOOKS FOR A SOPHISTICATED SELECTION THAT OFFERS ENDLESS DESIGN POSSIBILITIES AND EXCEPTIONAL VERSATILITY.



NOT APPLICABLE  
FOR ALL PRODUCTS  
IN THIS SERIES. SEE CHARTS  
FOR FULL PRODUCT DETAILS.

# CORE FUNDAMENTALS™ – PLATINUM

## GLAZED PORCELAIN FLOOR AND GLAZED CERAMIC WALL & MOSAICS

STONE LOOK FINISHES: MATTE

### FLOOR TILE



WHITE AV17



BEIGE AV18



GREY AV19

### AVAILABLE TILE SIZES



12 x 24  
Floor Tile

STONE LOOK FINISHES: MATTE

### FLOOR TILE



ALABASTER SL75



JUTE SL76



QUILL SL77

### 2 x 2 MOSAIC



ALABASTER SL75



JUTE SL76



QUILL SL77

### AVAILABLE TILE SIZES



12 x 24  
Floor Tile



2 x 2  
Mosaic

STONE LOOK FINISHES: MATTE

### FLOOR TILE



CHALK IT50



CLIFF IT51



SHALE IT52

### 2 x 2 MOSAIC

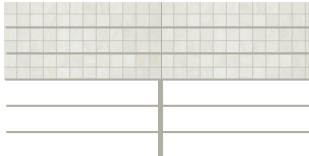

CHALK IT50

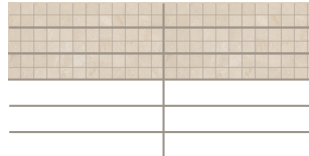

CLIFF IT51

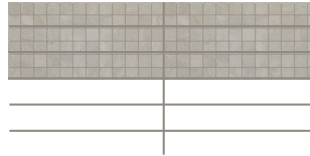

SHALE IT52

### AVAILABLE TILE SIZES



15 x 30  
Floor Tile



2 x 2  
Mosaic

# CORE FUNDAMENTALS™ – PLATINUM

GLAZED PORCELAIN FLOOR AND GLAZED CERAMIC WALL & MOSAICS

MARBLE LOOK

FINISHES: MATTE & GLOSSY

## FLOOR TILE



MAGNOLIA CT70



ALMOND CT71



DOVE CT72

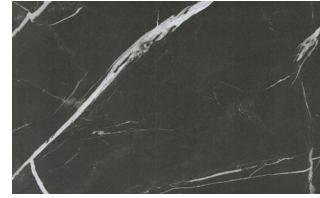

CARBON CT73



OYSTER CT74\*



CALACATTA SKY CT75\*\*



CALACATTA EMPIRE CT76

\*CT74 available in 12 x 24, 6 x 18, 2 x 2 mosaic only.

\*\*CT75 available in 12x24, 6x18, 4x12, and 2x2 mosaic only.

## 2 x 2 MOSAIC



MAGNOLIA  
CT70



ALMOND  
CT71

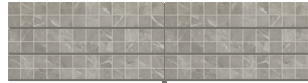

DOVE  
CT72

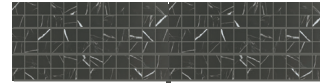

CARBON  
CT73

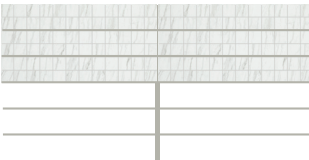

OYSTER  
CT74



CALACATTA SKY  
CT75

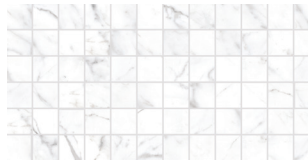

CALACATTA EMPIRE  
CT76

## AVAILABLE TILE SIZES



24 x 24  
Floor Tile



12 x 24  
Floor Tile



12 x 12  
Floor Tile



6 x 18  
Wall Tile\*



4 x 12  
Wall Tile\*\*



2 x 2  
Mosaic

\*Not available in CT73.

\*\* Available in CT75 & CT76 only.

# CORE FUNDAMENTALS™ – PLATINUM

## GLAZED PORCELAIN FLOOR AND GLAZED CERAMIC WALL & MOSAICS

**MARBLE LOOK** FINISHES: MATTE & GLOSSY

### FLOOR TILE

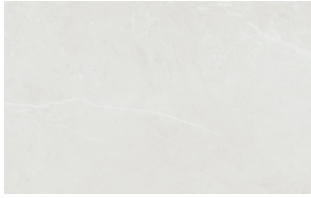

CLOUD PH60



MIST PH61



SAND PH62

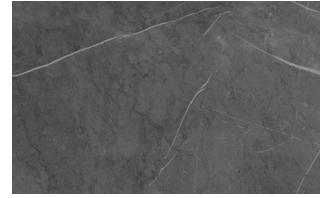

SMOKE PH63

### 2 x 2 MOSAIC



CLOUD PH60

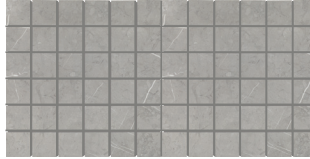

MIST PH61



SAND PH62

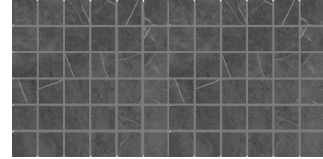

SMOKE PH63

#### AVAILABLE TILE SIZES



15 x 30  
Floor Tile



12 x 24  
Wall Tile\*



2 x 2  
Mosaic

\*PH60, PH61 & PH62 only.

**WOOD LOOK** FINISHES: MATTE

### FLOOR TILE



NATURAL HH01



GREIGE HH02



TEAK HH03



DARK BROWN HH04

#### AVAILABLE TILE SIZES



6 x 36  
Floor Tile

**WOOD LOOK** FINISHES: MATTE

### FLOOR TILE



NATURAL RB10

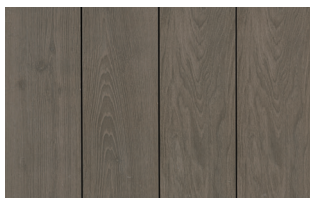

BROWN RB11



MEDIUM GRAY RB12

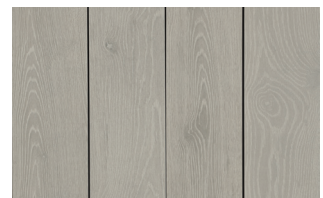

LIGHT GRAY RB13

#### AVAILABLE TILE SIZES



6 x 24  
Floor Tile

# CORE FUNDAMENTALS™ – PLATINUM

GLAZED PORCELAIN FLOOR AND GLAZED CERAMIC WALL & MOSAICS

**WOOD LOOK** FINISHES: MATTE

## FLOOR TILE



WHITE VL50



BROWN VL51



DARK BROWN VL52



GRAY VL53

### AVAILABLE TILE SIZES

  
6 x 24  
Floor Tile

**WOOD LOOK** FINISHES: MATTE

## FLOOR TILE



WHITE VC01



NATURAL VC02



HONEY VC03



BROWN VC04



GRAY BROWN VC05

### AVAILABLE TILE SIZES

  
6 x 36  
Floor Tile

**WOOD LOOK** FINISHES: MATTE

## FLOOR TILE



LOFT TH10



AVENUE TH11



VINTAGE TH12



CAVALRY TH13

### AVAILABLE TILE SIZES

  
8 x 48  
Floor Tile

# CORE FUNDAMENTALS™ – PLATINUM

GLAZED PORCELAIN FLOOR AND GLAZED CERAMIC WALL & MOSAICS

CONCRETE LOOK FINISHES: MATTE

## FLOOR TILE



WHITE UB02



GREY UB04

## 2 x 2 MOSAIC



WHITE UB02

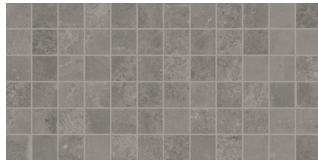

GREY UB04

## AVAILABLE TILE SIZES



12 x 24  
Floor Tile



2 x 2  
Mosaic

# CORE FUNDAMENTALS™ – PLATINUM

AVAILABLE SIZE & TRIM SHAPES

## PLATINUM

PLEASE REFER TO CHART ON NEXT PAGE FOR AVAILABILITY BASED ON COLOR CODE

FLOOR	SIZES	THICKNESS
	<b>15 x 30</b> Floor Tile	15-3/8" x 30-1/2" (39.15 cm x 77.60 cm) 5/16"
	<b>24 x 24</b> Floor Tile	23-13/16" x 23-13/16" (60.48 cm x 60.48 cm) 5/16"
	<b>12 x 24</b> Floor Tile	11-7/8" x 23-5/8" (30.23 cm x 60.12 cm) 5/16"
	<b>12 x 12</b> Floor Tile	11-13/16" x 11-13/16" (30.00 cm x 30.00 cm) 5/16"
	<b>8 x 48</b> Floor Tile	7-15/16" x 47-3/16" (20.26 cm x 120.00 cm) 3/8"
	<b>6 x 36</b> Floor Tile	5-15/16" x 35-7/16" (15.19 cm x 90.00) 5/16"
	<b>6 x 24</b> Floor Tile	6-1/16" x 23-7/8" (15.43 cm x 60.60 cm) 5/16"
WALL	SIZES	THICKNESS
	<b>4 x 12</b> Wall Tile	4-1/4" x 12-7/8" (10.91 cm x 32.77 cm) 5/16"
	<b>6 x 18</b> Wall Tile	6" x 18" (15.25 cm x 45.77 cm) 5/16"
	<b>12 x 24</b> Wall Tile	12" x 24" (30.51 cm x 61.03 cm) 3/8"

MOSAICS	SIZES	THICKNESS
	<b>2 x 2</b> Mosaic Dot-mounted	12" x 24" Sheet (30.48 cm x 60.96 cm Sheet) 1/4"
FLOOR TRIM		
	<b>P43C9</b>	3 x 12 Floor Bullnose
	<b>P439B</b>	3 x 15 Floor Bullnose
	<b>P43F9</b>	3 x 24 Floor Bullnose
WALL TRIM		
	<b>S1/212J</b>	12" Jolly

# CORE FUNDAMENTALS™ – PLATINUM

AVAILABLE SIZE & TRIM SHAPES

## PLATINUM

COLOR #	COLOR NAME	PAGE #	FLOOR									WALL				MOSAIC	
			FIELD TILE						BULLNOSE			FIELD TILE			JOLLY		
			15 x 30	24 x 24	12 x 24	12 x 12	8 x 48	6 x 36	6 x 24	P439B	P43C9	P43F9	12 x 24 Glossy	6 x 18 Glossy	4 x 12 Matte		S1/212J
AV17	White	21			●						●						
AV18	Beige	21			●						●						
AV19	Grey	21			●						●						
CT70	Magnolia	22		●	●	●					●		●		●	●	
CT71	Almond	22		●	●	●					●		●		●	●	
CT72	Dove	22		●	●	●					●		●		●	●	
CT73	Carbon	22		●	●	●					●		●		●	●	
CT74	Oyster	22			●						●		●		●	●	
CT75	Calacatta Sky	22			●						●		●	●	●	●	
CT76	Calacatta Empire	22		●	●	●					●		●	●	●	●	
HH01	Natural	23							●								
HH02	Greige	23							●								
HH03	Teak	23							●								
HH04	Dark Brown	23							●								
IT50	Chalk	21	●								●						●
IT51	Cliff	21	●								●						●
IT52	Shale	21	●								●						●
PH60	Cloud	23	●								●		●		●	●	
PH61	Mist	23	●								●		●		●	●	
PH62	Sand	23	●								●		●		●	●	
PH63	Smoke	23	●								●						●
RB10	Natural	23							●								
RB11	Brown	23							●								
RB12	Medium Gray	23							●								
RB13	Light Gray	23							●								
SL75	Alabaster	21			●							●					●
SL76	Jute	21			●							●					●
SL77	Quill	21			●							●					●
TH10	Loft	24					●										
TH11	Avenue	24					●										
TH12	Vintage	24					●										
TH13	Cavalry	24					●										
UB02	White	25			●							●					●
UB04	Grey	25			●							●					●
VL50	White	24							●								
VL51	Brown	24							●								
VL52	Dark Brown	24							●								
VL53	Gray	24							●								
VC01	White	24							●								
VC02	Natural	24							●								
VC03	Honey	24							●								
VC04	Brown	24							●								
VC05	Gray Brown	24							●								

# CORE FUNDAMENTALS™ – PLATINUM

GLAZED PORCELAIN FLOOR AND GLAZED CERAMIC WALL & MOSAICS

**PLATINUM: AV17, AV18, AV19 | HH01, HH02, HH03, HH04 | RB10, RB11, RB12, RB13 | TH10, TH11, TH12, TH13 | VL50, VL51, VL52, VL53 | VC01, VC02, VC03, VC04, VC05**

## APPLICATIONS

	Target DCOF wet	Suitable
Dry & Level – Interior Floor	N/A	✓
Wet & Level – Interior Floor	≥ 0.42	✓
Shower Floor – Standard Center Drain	≥ 0.42	
Shower Floor – Linear Drain	≥ 0.42	
Exterior Floor Applications (including patios, pool decking & other wet areas with minimal footwear)	≥ 0.60	
Ramps & Inclines	≥ 0.65	
Walls/Backsplashes	N/A	✓
Countertops	N/A	✓
Pool Linings	N/A	

A DCOF value of ≥0.42 is the standard for tiles specified for level interior spaces expected to be walked upon when wet, as stated in ANSI A137.1-A326.3. For more information about DCOF and the DCOF AcuTest™, visit [daltille.com/DCOF](http://daltille.com/DCOF).

### APPLICATION NOTES:

Suitable for exterior applications (provided it is noted as suitable in the applications chart above) in freezing and non-freezing climates, when proper installation methods are followed.

## INSTALLATION

Grout Joint Recommendation	Shade Variation
<b>Floor:</b> 3/16" (Overlap should not exceed 33% when installing tile with a length 15" or greater in a staggered brick-joint pattern.)	 High (V3)

## PERFORMANCE CHARACTERISTICS

	ASTM#	Floor Result
Water Absorption	C373	< 0.5%
Breaking Strength	C648	> 275 lbf
Scratch Hardness	C1895	8.0
Chemical Resistance	C650	Resistant

For additional information on test results, visit us at: [daltille.com/information/TestResults](http://daltille.com/information/TestResults).

## DURABILITY

### Floor Surface Wear Resistance

1 Residential Bathrooms	3 All Residential / Light Commercial
2 All Residential Areas	④ All Residential / Commercial

**PLATINUM: CT70, CT71, CT72, CT73, CT74, CT75, CT76 | PH60, PH61, PH62, PH63 | UB02, UB04 | SL75, SL76, SL77 | IT50, IT51, IT52 |**

## APPLICATIONS

	Target DCOF wet	Suitable
Dry & Level – Interior Floor	N/A	✓**
Wet & Level – Interior Floor	≥ 0.42	✓**
Shower Floor – Standard Center Drain	≥ 0.42	✓*
Shower Floor – Linear Drain	≥ 0.42	✓*
Exterior Floor Applications (including patios, pool decking & other wet areas with minimal footwear)	≥ 0.60	
Ramps & Inclines	≥ 0.65	
Walls/Backsplashes	N/A	✓
Countertops	N/A	✓**
Pool Linings	N/A	✓*

A DCOF value of ≥0.42 is the standard for tiles specified for level interior spaces expected to be walked upon when wet, as stated in ANSI A137.1-A326.3. For more information about DCOF and the DCOF AcuTest™, visit [daltille.com/DCOF](http://daltille.com/DCOF).



### APPLICATION NOTES:

Suitable for exterior applications (provided it is noted as suitable in the applications chart above) in freezing and non-freezing climates, when proper installation methods are followed.

\*\* Wall tile not suitable for this application

\* Mosaic tile only

## INSTALLATION

Grout Joint Recommendation	Shade Variation
<b>Floor:</b> 3/16" (Overlap should not exceed 33% when installing tile with a length 15" or greater in a staggered brick-joint pattern.)	 Medium (V2) PH60, PH61, PH62 & PH63
<b>Wall:</b> 1/16" (1/8" when rectangular size is installed in a staggered brick-joint pattern; overlap should not exceed 33%.)	 High (V3) CT70, CT71, CT72, CT73, CT74, CT75, CT76, UB02 & UB04, IT50, IT51, IT52, SL75, SL76 & SL77
<b>Mosaic:</b> 1/8"	

## PERFORMANCE CHARACTERISTICS

	ASTM#	Floor Result	Wall Result	Mosaic Result
Water Absorption	C373	< 0.5%	< 20.0%	< 3.0%
Breaking Strength	C648	> 275 lbf	120-230 lbf	> 250 lbf
Scratch Hardness	C1895	8.0	4.0-6.0	8.0
Chemical Resistance	C650	Resistant	Resistant	Resistant

For additional information on test results, visit us at: [daltille.com/information/TestResults](http://daltille.com/information/TestResults).

## DURABILITY

### Floor Surface Wear Resistance

1 Residential Bathrooms	3 All Residential / Light Commercial
2 All Residential Areas	④ All Residential / Commercial





## IMAGE DIRECTORY

### COVER

Photo features Core Fundamentals™ Platinum Brown VC04 on the floor with One Quartz Surfaces® Freedom Calacatta OQ42 on the countertop.

### PAGE 2

Photo features Core Fundamentals™ Prime White BA30 on the floor.

### PAGE 3 – CHOICE

Photo features Core Fundamentals™ Choice Iron CS23 on the floor.

### PAGE 3 – ADVANTAGE

Photo features Core Fundamentals™ Advantage Trumpet Grey EP22 on the floor with Aria White EP20 on the wall and Natural Stone Quartzite Slab Lamberti Bianco QO15 on the countertop.

### PAGE 3 – PRIME

Photo features Core Fundamentals™ Prime Grey EL32 on the floor with Revalia™ Remix Radiant Blue RV33 on the wall.

### PAGE 3 – PLATINUM

Photo features Core Fundamentals™ Platinum Mist PH61 on the floor and shower floor with Artcrafted™ Coconut AC23 on the shower walls and Panoramic Porcelain Surfaces™ Calacatta Aries CM21 on the countertop.

### PAGE 4

Photo features Core Fundamentals™ Weathered White SQ20 on the floor with Shadow Grey SQ22 on the backsplash.

### PAGE 8

Photo features Core Fundamentals™ Advantage Distressed Beige LS41 on the floor and shower floor with Mesmerist™ Allure MM33 on the shower walls and Natural Stone Slab Granite Colonial Gold G422 on the countertop and shower bench.

### PAGE 13

Photo features Core Fundamentals™ Advantage Mural Taupe AQ02 on the floor with One Quartz Surfaces® Patriotic OQ47 on the countertop.

### PAGE 14

Photo features Core Fundamentals™ Prime Historic Grey NS12 on the floor with Heirloom White NS10 on the wall and Natural Stone Granite Slab White River G848 on the countertop.

### PAGE 22

Photo features Core Fundamentals™ Platinum Smoke PH63 on the floor with One Quartz Surfaces® Pulsar OQ61 on the countertop.

### PAGE 25

Photo features Core Fundamentals™ Platinum Brown VC04 on the floor with One Quartz Surfaces® Freedom Calacatta OQ42 on the countertop.

### BACK COVER

Photo features Core Fundamentals™ Platinum Calacatta Empire CT76 on the floor, shower floor and shower walls with Natural Stone Granite Slab Himalaya White G217 on the countertop.

