



CORE FUNDAMENTALS™

CHOICE | ADVANTAGE | PRIME | PLATINUM





CORE FUNDAMENTALS™

CHOICE



ADVANTAGE



PRIME



PLATINUM



STONE
LOOK

USAGE



FLOOR



WALL



COUNTERTOP



SHOWER
FLOOR



EXTERIOR
FLOOR



STEPWISE™



TRU-EDGE™



MADE IN
THE U.S.A.



LARGE
FORMAT



MOSAIC/
DECO



ENCAUSTIC



TERRAZZO



PAVER



CUSTOMIZE



FLEXFIT™



CG
SLIP
GRADE

LOW HIGH

SPECIAL FEATURES



CORE FUNDAMENTALS™ CHOICE

THE **CHOICE TIER** HIGHLIGHTS THE BASICS WITH A VARIETY OF FLOOR TILE AND MOSAICS. EXCELLENT FOR EVERYDAY USE.



NOT APPLICABLE
FOR ALL PRODUCTS
IN THIS SERIES. SEE CHARTS
FOR FULL PRODUCT DETAILS.

CORE FUNDAMENTALS™ – CHOICE

GLAZED CERAMIC FLOOR & MOSAICS

STONE LOOK FINISHES: MATTE

FLOOR TILE



WEATHERED WHITE SQ20



BURROW BEIGE SQ21



SHADOW GREY SQ22

2 x 2 MOSAIC



WEATHERED WHITE SQ20



BURROW BEIGE SQ21

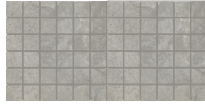

SHADOW GREY SQ22

AVAILABLE TILE SIZES



18 x 18
Floor Tile



12 x 24
Floor Tile



12 x 12
Floor Tile



2 x 2
Mosaic

STONE LOOK FINISHES: MATTE

FLOOR TILE



IVORY AR04



CASPER AR05



FAWN AR02

AVAILABLE TILE SIZES



15 x 15
Floor Tile



12 x 24
Floor Tile



12 x 12
Floor Tile

STONE LOOK FINISHES: MATTE

FLOOR TILE



FAIR CS22



BUFF CS20



IRON CS23

2 x 2 MOSAIC



FAIR CS22

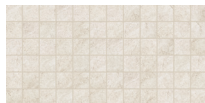

BUFF CS20

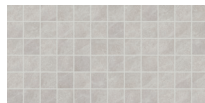

IRON CS23

AVAILABLE TILE SIZES



18 x 18
Floor Tile



12 x 24
Floor Tile



12 x 12
Floor Tile



2 x 2
Mosaic

STONE LOOK FINISHES: MATTE

FLOOR TILE



EVEREST WHITE CG05



TWILIGHT GREY CG07

AVAILABLE TILE SIZES



18 x 18
Floor Tile



12 x 24
Floor Tile









12 x 12
Floor Tile

CORE FUNDAMENTALS™ – CHOICE

AVAILABLE SIZE & TRIM SHAPES

CHOICE

PLEASE REFER TO THE CHART BELOW FOR AVAILABILITY BASED ON COLOR CODE

FLOOR			THICKNESS	FLOOR TRIM		
	18 x 18 Floor Tile	17-11/16" x 17-11/16" (45.01 cm x 45.01 cm)	5/16"		P43C9	3 x 12 Floor Bullnose
	15 x 15 Floor Tile	14-5/8" x 14-5/8" (37.30 cm x 37.30 cm)	5/16"			
	12 x 24 Floor Tile	11-13/16" x 23-11/16" (30.02 cm x 60.12 cm)	5/16"			
	12 x 12 Floor Tile	11-13/16" x 11-13/16" (30.02 cm x 30.02 cm)	5/16"			
MOSAICS			THICKNESS			
	2 x 2 Mosaic Dot-mounted	(12" x 24" Sheet) (30.48 cm x 60.96 cm Sheet)	1/4"			

COLOR #	COLOR NAME	PAGE #	FLOOR				MOSAIC	
			FIELD TILE					BULLNOSE
			18 x 18	15 x 15	12 x 24	12 x 12		P43C9
AR02	Fawn	5		●	●	●	●	
AR04	Ivory	5		●	●	●	●	
AR05	Casper	5		●	●	●	●	
CG05	Everest White	5	●		●	●	●	
CG07	Twilight Grey	5	●		●	●	●	
CS20	Buff	5	●		●	●	●	●
CS22	Fair	5	●		●	●	●	●
CS23	Iron	5	●		●	●	●	●
SQ20	Weathered White	5	●		●	●	●	●
SQ21	Burrow Beige	5	●		●	●	●	●
SQ22	Shadow Grey	5	●		●	●	●	●

CORE FUNDAMENTALS™ – CHOICE

APPLICATION SPECIFICATIONS

CHOICE – AR02 | AR04 | AR05 | SQ20 | SQ21 | SQ22 | CG05 | CG07

APPLICATIONS

	Target DCOF wet	Suitable
Dry & Level – Interior Floor	N/A	✓
Wet & Level – Interior Floor	≥ 0.42	✓
Shower Floor – Standard Center Drain	≥ 0.42	✓*
Shower Floor – Linear Drain	≥ 0.42	✓*
Exterior Floor Applications (including patios, pool decking & other wet areas with minimal footwear)	≥ 0.60	
Ramps & Inclines	≥ 0.65	
Walls/Backsplashes	N/A	✓
Countertops	N/A	✓
Pool Linings	N/A	✓*



A DCOF value of ≥0.42 is the standard for tiles specified for level interior spaces expected to be walked upon when wet, as stated in ANSI A137.1-A326.3. For more information about DCOF and the DCOF AcuTest™, visit daltile.com/DCOF.

APPLICATION NOTES:

Suitable for exterior applications (provided it is noted as suitable in the applications chart above) in non-freezing climates, when proper installation methods are followed.

* Mosaic tile only.

INSTALLATION

Grout Joint Recommendation	Shade Variation
Floor: 3/16" (Overlap should not exceed 33% when installing tile with a length 15" or greater in a staggered brick-joint pattern.)	 Medium (V2) SQ20, SQ21 & SQ22
Mosaic: 1/8"	 High (V3) AR02, AR04, AR05, CG05 & CG07

PERFORMANCE CHARACTERISTICS

	ASTM#	Result
Water Absorption	C373	< 7.0%
Breaking Strength	C648	> 250 lbf
Scratch Hardness	C1895	8.0
Chemical Resistance	C650	Resistant

For additional information on test results, visit us at: daltile.com/information/TestResults.

DURABILITY

Floor Surface Wear Resistance

1 Residential Bathrooms	③	All Residential / Light Commercial
2 All Residential Areas	4	All Residential / Commercial

CHOICE – CS20 | CS22 | CS23

APPLICATIONS

	Target DCOF wet	Suitable
Dry & Level – Interior Floor	N/A	✓
Wet & Level – Interior Floor	≥ 0.42	✓
Shower Floor – Standard Center Drain	≥ 0.42	✓*
Shower Floor – Linear Drain	≥ 0.42	✓*
Exterior Floor Applications (including patios, pool decking & other wet areas with minimal footwear)	≥ 0.60	
Ramps & Inclines	≥ 0.65	
Walls/Backsplashes	N/A	✓
Countertops	N/A	✓
Pool Linings	N/A	✓*

A DCOF value of ≥0.42 is the standard for tiles specified for level interior spaces expected to be walked upon when wet, as stated in ANSI A137.1-A326.3. For more information about DCOF and the DCOF AcuTest™, visit daltile.com/DCOF.

APPLICATION NOTES:

Suitable for exterior applications (provided it is noted as suitable in the applications chart above) in non-freezing climates, when proper installation methods are followed.

* Mosaic tile only.

INSTALLATION

Grout Joint Recommendation	Shade Variation
Floor: 3/16" (Overlap should not exceed 33% when installing tile with a length 15" or greater in a staggered brick-joint pattern.)	 Medium (V2)
Mosaic: 1/8"	

PERFORMANCE CHARACTERISTICS

	ASTM#	Floor Result	Mosaic Result
Water Absorption	C373	< 7.0%	< 3.0%
Breaking Strength	C648	> 250 lbf	> 250 lbf
Scratch Hardness	C1895	7.0	7.0
Chemical Resistance	C650	Resistant	Resistant

For additional information on test results, visit us at: daltile.com/information/TestResults.

DURABILITY

Floor Surface Wear Resistance

1 Residential Bathrooms	③	All Residential / Light Commercial
2 All Residential Areas	4	All Residential / Commercial

STONE
LOOK

USAGE



FLOOR



WALL



COUNTERTOP



SHOWER
FLOOR



EXTERIOR
FLOOR



STEPWISE™



TRU-EDGE™



MADE IN
THE U.S.A.



LARGE
FORMAT



MOSAIC/
DECO



ENCAUSTIC



TERRAZZO



PAVER



CUSTOMIZE



FLEXFIT™



CG
SLIP
GRADE



LOW HIGH

SPECIAL FEATURES



CORE FUNDAMENTALS™ ADVANTAGE

THE **ADVANTAGE TIER** IS RICH WITH A COMBINATION OF DIFFERENT FLOOR, WALL, AND MOSAICS TO EXCITE DESIGN, TO MIX AND MATCH OR CREATE A COHESIVE LOOK.



NOT APPLICABLE
FOR ALL PRODUCTS
IN THIS SERIES. SEE CHARTS
FOR FULL PRODUCT DETAILS.

CORE FUNDAMENTALS™ – ADVANTAGE

GLAZED CERAMIC FLOOR, WALL & MOSAICS

STONE LOOK FINISHES: MATTE

FLOOR TILE



WASHED WHITE LS40



DISTRESSED BEIGE LS41



AGED GREY LS42

2 x 4 BRICK-JOINT MOSAIC



WASHED WHITE LS40



DISTRESSED BEIGE LS41



AGED GREY LS42

AVAILABLE TILE SIZES



18 x 18
Floor Tile



12 x 24
Floor Tile



12 x 12
Floor Tile



2 x 4 Brick-joint
Mosaic

STONE LOOK FINISHES: MATTE & SATIN

FLOOR TILE



PORTRAIT WHITE AQ01



MURAL TAUPE AQ02



RENOIR GREY AQ03

2 x 4 BRICK-JOINT MOSAIC



PORTRAIT WHITE AQ01



MURAL TAUPE AQ02



RENOIR GREY AQ03

AVAILABLE TILE SIZES



18 x 18
Floor Tile



12 x 24
Floor Tile



12 x 12
Floor Tile



10 x 14
Wall Tile*



2 x 4 Brick-joint
Mosaic

*10 x 14 available in AQ02 & AQ03 only.

CORE FUNDAMENTALS™ – ADVANTAGE

GLAZED CERAMIC FLOOR, WALL & MOSAICS

STONE LOOK FINISHES: MATTE

FLOOR TILE



ARIA WHITE EP20



PERCUSSION TAUPE EP21



TRUMPET GREY EP22

2 x 4 HERRINGBONE MOSAIC



ARIA WHITE EP20



PERCUSSION TAUPE EP21



TRUMPET GREY EP22

AVAILABLE TILE SIZES



18 x 18
Floor Tile



12 x 24
Floor Tile



12 x 12
Floor Tile



2 x 4
Herringbone Mosaic

CONCRETE LOOK FINISHES: MATTE

FLOOR TILE



WHITE CANVAS SV16



GOLDEN SAND SV17



CEMENT GREY SV18

2 x 2 MOSAIC



WHITE CANVAS SV16



GOLDEN SAND SV17



CEMENT GREY SV18

AVAILABLE TILE SIZES



18 x 18
Floor Tile



12 x 24
Floor Tile













2 x 2
Mosaic

CORE FUNDAMENTALS™ – ADVANTAGE

AVAILABLE SIZE & TRIM SHAPES

ADVANTAGE

PLEASE REFER TO THE CHART BELOW FOR AVAILABILITY BASED ON COLOR CODE

FLOOR			THICKNESS			FLOOR TRIM		
	18 x 18 Floor Tile	17-11/16" x 17-11/16" (45.01 cm x 45.01 cm)	5/16"				P43C9	3 x 12 Floor Bullnose
	12 x 24 Floor Tile	11-13/16" x 23-11/16" (30.02 cm x 60.12 cm)	5/16"			WALL TRIM		
	12 x 12 Floor Tile	11-13/16" x 11-13/16" (30.02 cm x 30.02 cm)	5/16"				S4310	3 x 10 Wall Bullnose
WALL			THICKNESS				SN4310	3 x 3 Wall Bullnose Corner
	10 x 14 Wall Tile	9-13/16" x 13-15/16" (24.99 cm x 35.40 cm)	5/16"					
MOSAICS			THICKNESS					
	2 x 4 Brick-joint Mosaic Dot-mounted	12" x 12" Sheet (30.48 cm x 30.48 cm Sheet)	1/4"					
	2 x 4 Herringbone Mosaic Dot-mounted	14" x 12" Sheet (35.56 cm x 30.48 cm Sheet)	1/4"					
	2 x 2 Mosaic Dot-mounted	12" x 12" Sheet (30.48 cm x 30.48 cm Sheet)	1/4"					

ADVANTAGE

COLOR #	COLOR NAME	PAGE #	FLOOR				WALL		MOSAIC		
			FIELD TILE			BULLNOSE	FIELD TILE	BULLNOSE	2 x 4 BRICK-JOINT	2 x 4 HERRINGBONE	2 x 2
			18 x 18	12 x 24	12 x 12	P43C9	10 X 14 AQ SATIN FINISH SV MATTE FINISH	S4310 SN4310			
AQ01	Portrait White	09	●	●	●	●			●		
AQ02	Mural Taupe	09	●	●	●	●	●	●	●	●	
AQ03	Renoir Grey	09	●	●	●	●	●	●	●		
EP20	Aria White	10	●	●	●	●				●	
EP21	Percussion Taupe	10	●	●	●	●				●	
EP22	Trumpet Grey	10	●	●	●	●				●	
LS40	Washed White	09	●	●	●	●			●		
LS41	Distressed Beige	09	●	●	●	●			●		
LS42	Aged Grey	09	●	●	●	●			●		
SV16	White Canvas	10	●	●		●					●
SV17	Golden Sand	10	●	●		●					●
SV18	Cement Grey	10	●	●		●					●

CORE FUNDAMENTALS™ – ADVANTAGE

APPLICATION SPECIFICATIONS

ADVANTAGE: AQ01 | AQ02 | AQ03 | EP20 | EP21 | EP22 | LS40 | LS41 | LS42 | SV16 | SV17 | SV18

APPLICATIONS

	Target DCOF wet	Suitable
Dry & Level – Interior Floor	N/A	✓**
Wet & Level – Interior Floor	≥ 0.42	✓**
Shower Floor – Standard Center Drain	≥ 0.42	✓*
Shower Floor – Linear Drain	≥ 0.42	✓*
Exterior Floor Applications (including patios, pool decking & other wet areas with minimal footwear)	≥ 0.60	
Ramps & Inclines	≥ 0.65	
Walls/Backsplashes	N/A	✓
Countertops	N/A	✓**
Pool Linings	N/A	✓*

A DCOF value of ≥0.42 is the standard for tiles specified for level interior spaces expected to be walked upon when wet, as stated in ANSI A137.1-A326.3. For more information about DCOF and the DCOF AcuTest™, visit daltille.com/DCOF.



APPLICATION NOTES:

Suitable for exterior applications (provided it is noted as suitable in the applications chart above) in non-freezing climates, when proper installation methods are followed. Wall tile suitable for walls/backsplashes only.

** Wall tile not suitable for application

* Mosaic tile only

INSTALLATION

Grout Joint Recommendation	Shade Variation
Floor: 3/16" (Overlap should not exceed 33% when installing tile with a length 15" or greater in a staggered brick-joint pattern.)	 Medium (V2) SV16, SV17 & SV18
Mosaic: 1/8"	 High (V3) AQ01, AQ02, AQ03, EP20, EP21, EP22, LS40, LS41 & LS42
Wall: 1/16"	

PERFORMANCE CHARACTERISTICS

	ASTM#	Floor Result	Wall Result	Mosaic Result
Water Absorption	C373	< 7.0%	< 20.0%	< 3.0%
Breaking Strength	C648	> 250 lbf	120-230 lbf	> 250 lbf
Scratch Hardness	C1895	7.0	4.0-6.0	8.0
Chemical Resistance	C650	Resistant	Resistant	Resistant

For additional information on test results, visit us at: daltille.com/information/TestResults.

DURABILITY

Floor Surface Wear Resistance			
1	Residential Bathrooms	③	All Residential / Light Commercial
2	All Residential Areas	4	All Residential / Commercial



STONE
LOOK

USAGE



FLOOR



WALL



COUNTERTOP



SHOWER
FLOOR



EXTERIOR
FLOOR



STEPWISE™



TRU-EDGE™



MADE IN
THE U.S.A.



LARGE
FORMAT



MOSAIC/
DECO



ENCAUSTIC



TERRAZZO



PAVER



CUSTOMIZE



FLEXFIT™



CG
SLIP
GRADE



LOW HIGH

SPECIAL FEATURES

CORE FUNDAMENTALS™ PRIME

THE **PRIME TIER** PROVIDES ALL THE ESSENTIAL BENEFITS OF TILE WHILE OFFERING AN ARRAY OF DIFFERENT LOOKS AND DECORATIVE ACCENTS TO HEIGHTEN DESIGN.

NOT APPLICABLE
FOR ALL PRODUCTS
IN THIS SERIES. SEE CHARTS
FOR FULL PRODUCT DETAILS.

CORE FUNDAMENTALS™ – PRIME

GLAZED CERAMIC FLOOR, WALL & MOSAICS

STONE LOOK FINISHES: MATTE & GLOSSY

FLOOR TILE



HEIRLOOM WHITE NS10



LINEAGE GREIGE NS11



HISTORIC GREY NS12

1 x 3 HERRINGBONE MOSAIC



HEIRLOOM WHITE NS10



LINEAGE GREIGE NS11



HISTORIC GREY NS12

AVAILABLE TILE SIZES



18 x 18
Floor Tile



12 x 24
Floor Tile



8 x 24
Wall Tile



1 x 3 Herringbone
Mosaic

STONE LOOK FINISHES: MATTE

FLOOR TILE



WHITE BA30



CHARCOAL BA34

2 x 4 MOSAIC



WHITE BA30

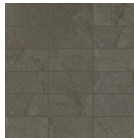

CHARCOAL BA34

AVAILABLE TILE SIZES



18 x 18
Floor Tile



12 x 24
Floor Tile



12 x 12
Floor Tile



10 x 14
Wall Tile



2 x 4 Straight-joint
Mosaic

MONOCHROMATIC LOOK FINISHES: MATTE

FLOOR TILE

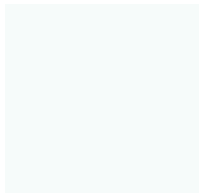

RAINIER 1500

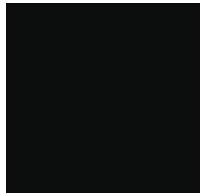

BLACK 2011

AVAILABLE TILE SIZES



12 x 12
Floor Tile

CORE FUNDAMENTALS™ – PRIME

GLAZED CERAMIC FLOOR, WALL & MOSAICS

STONE LOOK FINISHES: MATTE

FLOOR TILE



WHITE EL30



BEIGE EL31



GREY EL32

1 x 3 HERRINGBONE MOSAIC



WHITE EL30



BEIGE EL31



GREY EL32

AVAILABLE TILE SIZES



CONCRETE LOOK FINISHES: MATTE

FLOOR TILE

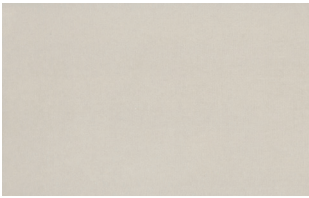

WHITE KC01

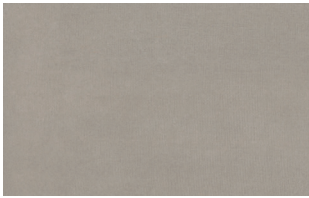

GREY KC04

2 x 2 MOSAIC

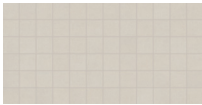

WHITE KC01



GREY KC04

AVAILABLE TILE SIZES

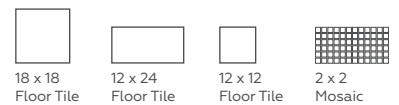

STONE LOOK FINISHES: MATTE

FLOOR TILE



VITALITY WHITE RL20

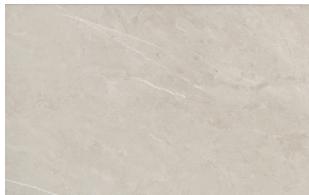

DYNAMIC BEIGE RL21



STAMINA GREY RL23

1.5" HEX MOSAIC



VITALITY WHITE
RL20



DYNAMIC BEIGE
RL21

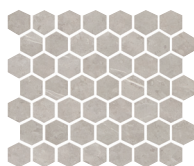

STAMINA GREY
RL23

AVAILABLE TILE SIZES

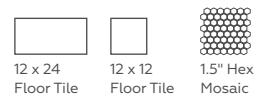







CORE FUNDAMENTALS™ – PRIME





AVAILABLE SIZE & TRIM SHAPES



PRIME



PLEASE REFER TO THE CHART BELOW FOR AVAILABILITY BASED ON COLOR CODE

FLOOR	SIZES	THICKNESS
	18 x 18 Floor Tile 17-11/16" x 17-11/16" (45.01 cm x 45.01 cm)	5/16"
	12 x 24 Floor Tile 11-13/16" x 23-11/16" (30.02 cm x 60.12 cm)	5/16"
	12 x 12 Floor Tile 11-13/16" x 11-13/16" (30.02 cm x 30.02 cm)	5/16"

WALL	SIZES	THICKNESS
	8 x 24 Wall Tile 8" x 24" (20.34 cm x 61.30 cm)	3/8"
	10 x 14 Wall Tile 9-13/16" x 13-15/16" (24.99 cm x 35.43 cm)	5/16"
	4 x 12 Wall Tile 4-1/4" x 12-7/8" (10.88 cm x 32.76 cm)	5/16"

MOSAICS	SIZES	THICKNESS
	2 x 4 Straight-joint Mosaic Dot-mounted 12" x 12" Sheet (30.48 x 30.48 cm Sheet)	1/4"
	2 x 2 Mosaic Dot-mounted 12" x 24" Sheet (30.48 cm x 60.96 cm Sheet)	1/4"
	1.5" Hex Mosaic Dot-mounted 11-3/8" x 10-1/4" Sheet (28.89 cm x 26.04 cm Sheet)	1/4"
	1 x 3 Herringbone Mosaic Dot-mounted 9" x 12" Sheet (22.86 x 30.48 cm Sheet)	1/4"

FLOOR TRIM		
	P43F9	3 x 24 Floor Bullnose
	P43C9	3 x 12 Floor Bullnose

WALL TRIM		
	S1/212J	12" Jolly
	S4310	3 x 10 Wall Bullnose
	SN4310	3 x 3 Wall Bullnose Corner

COLOR #	COLOR NAME	PAGE #	FLOOR					WALL					MOSAIC			
			FIELD TILE			BULLNOSE		FIELD TILE			BULLNOSE		2 x 4 STRAIGHT-JOINT	2 x 2	1.5 HEXAGON	1 x 3 HERRINGBONE
			18 x 18	12 x 24	12 x 12	P43F9	P43C9	10 x 14 Matte	8 x 24 Glossy	4 x 12 Matte	S4310 SN4310	S1/212J				
BA30	White	15	●	●	●		●	●			●		●			
BA34	Charcoal	15	●	●	●		●	●			●		●			
EL30	White	16		●		●				●		●				●
EL31	Beige	16		●		●				●		●				●
EL32	Grey	16		●		●				●		●				●
KC01	White	16	●	●	●		●							●		
KC04	Grey	16	●	●	●		●							●		
NS10	Heirloom White	15	●	●			●		●		●					●
NS11	Lineage Greige	15	●	●			●		●		●					●
NS12	Historic Grey	15	●	●			●		●		●					●
RL20	Vitality White	16		●	●	●									●	
RL21	Dynamic Beige	16		●	●	●									●	
RL23	Stamina Grey	16		●	●	●									●	
1500	Rainier	15			●											
2011	Black	15			●											

CORE FUNDAMENTALS™ – PRIME

APPLICATION SPECIFICATIONS

PRIME: BA30 | BA34 | KC01 | KC04 | NS10 | NS11 | NS12

APPLICATIONS

	Target DCOF wet	Suitable
Dry & Level – Interior Floor	N/A	✓**
Wet & Level – Interior Floor	≥ 0.42	✓**
Shower Floor – Standard Center Drain	≥ 0.42	✓*
Shower Floor – Linear Drain	≥ 0.42	✓*
Exterior Floor Applications (including patios, pool decking & other wet areas with minimal footwear)	≥ 0.60	
Ramps & Inclines	≥ 0.65	
Walls/Backsplashes	N/A	✓
Countertops	N/A	✓**
Pool Linings	N/A	✓*

A DCOF value of ≥0.42 is the standard for tiles specified for level interior spaces expected to be walked upon when wet, as stated in ANSI A137.1-A326.3. For more information about DCOF and the DCOF AcuTest™, visit daltile.com/DCOF.



APPLICATION NOTES:

Suitable for exterior applications (provided it is noted as suitable in the applications chart above) in non-freezing climates, when proper installation methods are followed.

** Wall tile not suitable for this application

* Mosaic tile only

INSTALLATION

Grout Joint Recommendation	Shade Variation
Floor: 3/16" (Overlap should not exceed 33% when installing tile with a length 15" or greater in a staggered brick-joint pattern.)	 Medium (V2) NS10, NS11 & NS12
Wall: 1/16"	 High (V3) BA30, BA34, KC01 & KC04
Mosaic: 1/8"	

PERFORMANCE CHARACTERISTICS

	ASTM#	Floor Result	Wall Result	Mosaic Result
Water Absorption	C373	< 7.0%	< 20.0%	< 3.0%
Breaking Strength	C648	> 250 lbf	120-230 lbf	> 250 lbf
Scratch Hardness	C1895	7.0	4.0-6.0	7.0
Chemical Resistance	C650	Resistant	Resistant	Resistant

For additional information on test results, visit us at: daltile.com/information/TestResults.

DURABILITY

Floor Surface Wear Resistance

1 Residential Bathrooms (3)	All Residential / Light Commercial
2 All Residential Areas	4 All Residential / Commercial

PRIME: EL30 | EL31 | EL32

APPLICATIONS

	Target DCOF wet	Suitable
Dry & Level – Interior Floor	N/A	✓**
Wet & Level – Interior Floor	≥ 0.42	✓**
Shower Floor – Standard Center Drain	≥ 0.42	✓*
Shower Floor – Linear Drain	≥ 0.42	✓*
Exterior Floor Applications (including patios, pool decking & other wet areas with minimal footwear)	≥ 0.60	
Ramps & Inclines	≥ 0.65	
Walls/Backsplashes	N/A	✓
Countertops	N/A	✓**
Pool Linings	N/A	✓*

A DCOF value of ≥0.42 is the standard for tiles specified for level interior spaces expected to be walked upon when wet, as stated in ANSI A137.1-A326.3. For more information about DCOF and the DCOF AcuTest™, visit daltile.com/DCOF.

APPLICATION NOTES:

Suitable for exterior applications (provided it is noted as suitable in the applications chart above) in non-freezing climates, when proper installation methods are followed.

** Wall tile not suitable for this application

* Mosaic tile only

INSTALLATION

Grout Joint Recommendation	Shade Variation
Floor: 3/16" (Overlap should not exceed 33% when installing tile with a length 15" or greater in a staggered brick-joint pattern.)	 High (V3)
Wall: 1/16" (When rectangular size is installed in a staggered brick-joint pattern, overlap should not exceed 33%)	
Mosaic: 1/8"	

PERFORMANCE CHARACTERISTICS

	ASTM#	Floor Result	Wall Result	Mosaic Result
Water Absorption	C373	< 7.0%	< 20.0%	< 3.0%
Breaking Strength	C648	> 250 lbf	120-230 lbf	> 250 lbf
Scratch Hardness	C1895	8.0	4.0-6.0	7.0
Chemical Resistance	C650	Resistant	Resistant	Resistant

For additional information on test results, visit us at: daltile.com/information/TestResults.

DURABILITY

Floor Surface Wear Resistance

1 Residential Bathrooms (3)	All Residential / Light Commercial
2 All Residential Areas	4 All Residential / Commercial

CORE FUNDAMENTALS™ – PRIME

APPLICATION SPECIFICATIONS

PRIME: RL20 | RL21 | RL23

APPLICATIONS

	Target DCOF wet	Suitable
Dry & Level – Interior Floor	N/A	✓**
Wet & Level – Interior Floor	≥ 0.42	✓**
Shower Floor – Standard Center Drain	≥ 0.42	✓*
Shower Floor – Linear Drain	≥ 0.42	✓*
Exterior Floor Applications (including patios, pool decking & other wet areas with minimal footwear)	≥ 0.60	
Ramps & Inclines	≥ 0.65	
Walls/Backsplashes	N/A	✓
Countertops	N/A	✓**
Pool Linings	N/A	✓*

A DCOF value of ≥0.42 is the standard for tiles specified for level interior spaces expected to be walked upon when wet, as stated in ANSI A137.1-A326.3. For more information about DCOF and the DCOF AcuTest™, visit daltile.com/DCOF.

APPLICATION NOTES:

Suitable for exterior applications (provided it is noted as suitable in the applications chart above) in non-freezing climates, when proper installation methods are followed.

** Wall tile not suitable for this application

* Mosaic tile only

INSTALLATION

Grout Joint Recommendation	Shade Variation
<p>Floor: 3/16" (Overlap should not exceed 33% when installing tile with a length 15" or greater in a staggered brick-joint pattern.)</p> <p>Wall: 10 x 14: 1/16" 4 x 16: 1/16" (When rectangular size is installed in a staggered brick-joint pattern, overlap should not exceed 33%)</p> <p>Mosaic: 1/8"</p>	 High (V3)

PERFORMANCE CHARACTERISTICS

	ASTM#	Floor Result	Wall Result	Mosaic Result
Water Absorption	C373	< 7.0%	< 20.0%	< 3.0%
Breaking Strength	C648	> 250 lbf	120-230 lbf	> 250 lbf
Scratch Hardness	C1895	8.0	4.0-6.0	8.0
Chemical Resistance	C650	Resistant	Resistant	Resistant

For additional information on test results, visit us at: daltile.com/information/TestResults.

DURABILITY

Floor Surface Wear Resistance

1	Residential Bathrooms (3)	All Residential / Light Commercial
2	All Residential Areas	4 All Residential / Commercial

PRIME: 1500 | 2011

APPLICATIONS

	Target DCOF wet	Suitable
Dry & Level – Interior Floor	N/A	✓
Wet & Level – Interior Floor	≥ 0.42	
Shower Floor – Standard Center Drain	≥ 0.42	
Shower Floor – Linear Drain	≥ 0.42	
Exterior Floor Applications (including patios, pool decking & other wet areas with minimal footwear)	≥ 0.60	
Ramps & Inclines	≥ 0.65	
Walls/Backsplashes	N/A	✓
Countertops	N/A	✓
Pool Linings	N/A	

A DCOF value of ≥0.42 is the standard for tiles specified for level interior spaces expected to be walked upon when wet, as stated in ANSI A137.1-A326.3. For more information about DCOF and the DCOF AcuTest™, visit daltile.com/DCOF.

APPLICATION NOTES:

Suitable for exterior applications (provided it is noted as suitable in the applications chart above) in non-freezing climates, when proper installation methods are followed.

INSTALLATION

Grout Joint Recommendation	Shade Variation
3/16"	 Low (V1)

PERFORMANCE CHARACTERISTICS

	ASTM#	Result
Water Absorption	C373	< 7.0%
Breaking Strength	C648	> 250 lbf
Scratch Hardness	C1895	7.0
Chemical Resistance	C650	Resistant

For additional information on test results, visit us at: daltile.com/information/TestResults.

DURABILITY

Floor Surface Wear Resistance

1	Residential Bathrooms (3)	All Residential / Light Commercial
2	All Residential Areas	4 All Residential / Commercial

STONE
LOOK

USAGE



FLOOR



WALL



COUNTERTOP



SHOWER
FLOOR



EXTERIOR
FLOOR



STEPWISE™



TRU-EDGE™



MADE IN
THE U.S.A.



LARGE
FORMAT



MOSAIC/
DECO



ENCAUSTIC



TERRAZZO



PAVER



CUSTOMIZE



FLEXFIT™



LOW HIGH

SPECIAL FEATURES



CORE FUNDAMENTALS™ PLATINUM

THE **PLATINUM TIER** OFFERS THE LOOK OF LUXURY, COMBINING MARBLE, WOOD, AND STONE LOOKS FOR A SOPHISTICATED SELECTION THAT OFFERS ENDLESS DESIGN POSSIBILITIES AND EXCEPTIONAL VERSATILITY.



NOT APPLICABLE
FOR ALL PRODUCTS
IN THIS SERIES. SEE CHARTS
FOR FULL PRODUCT DETAILS.

CORE FUNDAMENTALS™ – PLATINUM

GLAZED PORCELAIN FLOOR AND GLAZED CERAMIC WALL & MOSAICS

STONE LOOK FINISHES: MATTE

FLOOR TILE



WHITE AV17



BEIGE AV18



GREY AV19

AVAILABLE TILE SIZES



12 x 24
Floor Tile

STONE LOOK FINISHES: MATTE

FLOOR TILE



ALABASTER SL75



JUTE SL76



QUILL SL77

2 x 2 MOSAIC



ALABASTER SL75



JUTE SL76



QUILL SL77

AVAILABLE TILE SIZES



12 x 24
Floor Tile



2 x 2
Mosaic

STONE LOOK FINISHES: MATTE

FLOOR TILE



CHALK IT50



CLIFF IT51



SHALE IT52

2 x 2 MOSAIC



CHALK IT50



CLIFF IT51



SHALE IT52

AVAILABLE TILE SIZES



15 x 30
Floor Tile



2 x 2
Mosaic

CORE FUNDAMENTALS™ – PLATINUM

GLAZED PORCELAIN FLOOR AND GLAZED CERAMIC WALL & MOSAICS

MARBLE LOOK FINISHES: MATTE & GLOSSY

FLOOR TILE



MAGNOLIA CT70



ALMOND CT71



DOVE CT72

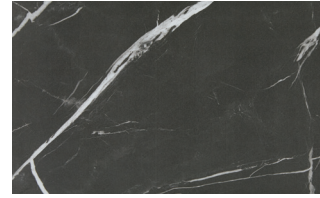

CARBON CT73



OYSTER CT74*



CALACATTA SKY CT75**



CALACATTA EMPIRE CT76

*CT74 available in 12 x 24, 6 x 18, 2 x 2 mosaic only.

**CT75 available in 12x24, 6x18, 4x12, and 2x2 mosaic only.

2 x 2 MOSAIC



MAGNOLIA
CT70



ALMOND
CT71

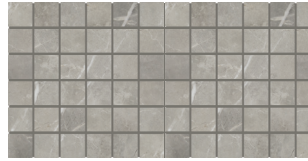

DOVE
CT72

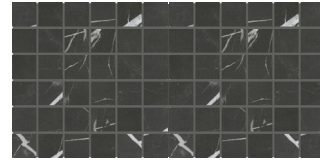

CARBON
CT73



OYSTER
CT74



CALACATTA SKY
CT75

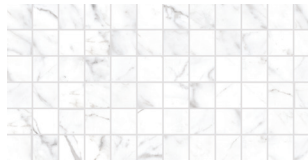

CALACATTA EMPIRE
CT76

AVAILABLE TILE SIZES



24 x 24
Floor Tile



12 x 24
Floor Tile



12 x 12
Floor Tile



6 x 18
Wall Tile*



4 x 12
Wall Tile**



2 x 2
Mosaic

*Not available in CT73.

** Available in CT75 & CT76 only.

CORE FUNDAMENTALS™ – PLATINUM

GLAZED PORCELAIN FLOOR AND GLAZED CERAMIC WALL & MOSAICS

MARBLE LOOK FINISHES: MATTE & GLOSSY

FLOOR TILE

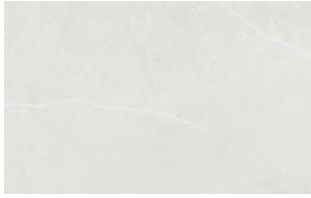

CLOUD PH60



MIST PH61



SAND PH62

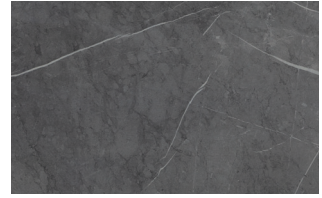

SMOKE PH63

2 x 2 MOSAIC



CLOUD PH60

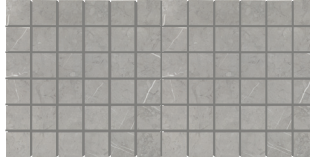

MIST PH61



SAND PH62

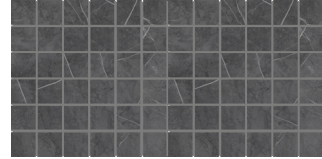

SMOKE PH63

AVAILABLE TILE SIZES



15 x 30
Floor Tile



12 x 24
Wall Tile*



2 x 2
Mosaic

*PH60, PH61 & PH62 only.

WOOD LOOK FINISHES: MATTE

FLOOR TILE



NATURAL HH01



GREIGE HH02



TEAK HH03



DARK BROWN HH04

AVAILABLE TILE SIZES



6 x 36
Floor Tile

WOOD LOOK FINISHES: MATTE

FLOOR TILE

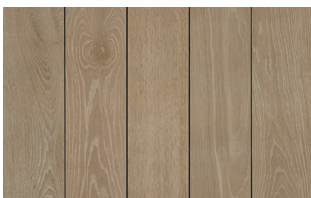

NATURAL RB10

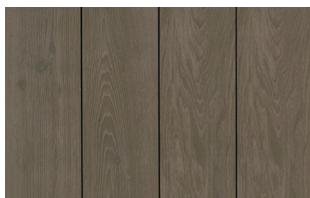

BROWN RB11

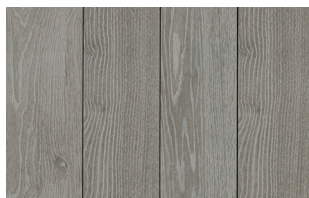

MEDIUM GRAY RB12

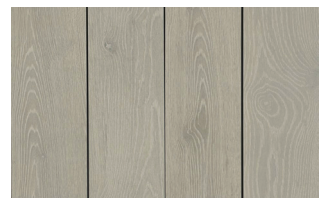

LIGHT GRAY RB13

AVAILABLE TILE SIZES



6 x 24
Floor Tile

CORE FUNDAMENTALS™ – PLATINUM

GLAZED PORCELAIN FLOOR AND GLAZED CERAMIC WALL & MOSAICS

WOOD LOOK FINISHES: MATTE

FLOOR TILE



WHITE VL50



BROWN VL51



DARK BROWN VL52



GRAY VL53

AVAILABLE TILE SIZES

6 x 24
Floor Tile

WOOD LOOK FINISHES: MATTE

FLOOR TILE



WHITE VC01



NATURAL VC02



HONEY VC03



BROWN VC04



GRAY BROWN VC05

AVAILABLE TILE SIZES

6 x 36
Floor Tile

WOOD LOOK FINISHES: MATTE

FLOOR TILE



LOFT TH10



AVENUE TH11



VINTAGE TH12



CAVALRY TH13

AVAILABLE TILE SIZES

8 x 48
Floor Tile

CORE FUNDAMENTALS™ – PLATINUM

GLAZED PORCELAIN FLOOR AND GLAZED CERAMIC WALL & MOSAICS

CONCRETE LOOK FINISHES: MATTE

FLOOR TILE



WHITE UB02



GREY UB04

2 x 2 MOSAIC



WHITE UB02



GREY UB04

AVAILABLE TILE SIZES



12 x 24
Floor Tile



2 x 2
Mosaic

CORE FUNDAMENTALS™ – PLATINUM

AVAILABLE SIZE & TRIM SHAPES

PLATINUM

PLEASE REFER TO CHART ON NEXT PAGE FOR AVAILABILITY BASED ON COLOR CODE

FLOOR	SIZES	THICKNESS
	15 x 30 Floor Tile	15-3/8" x 30-1/2" (39.15 cm x 77.60 cm) 5/16"
	24 x 24 Floor Tile	23-13/16" x 23-13/16" (60.48 cm x 60.48 cm) 5/16"
	12 x 24 Floor Tile	11-7/8" x 23-5/8" (30.23 cm x 60.12 cm) 5/16"
	12 x 12 Floor Tile	11-13/16" x 11-13/16" (30.00 cm x 30.00 cm) 5/16"
	8 x 48 Floor Tile	7-15/16" x 47-3/16" (20.26 cm x 120.00 cm) 3/8"
	6 x 36 Floor Tile	5-15/16" x 35-7/16" (15.19 cm x 90.00) 5/16"
	6 x 24 Floor Tile	6-1/16" x 23-7/8" (15.43 cm x 60.60 cm) 5/16"
WALL	SIZES	THICKNESS
	4 x 12 Wall Tile	4-1/4" x 12-7/8" (10.91 cm x 32.77 cm) 5/16"
	6 x 18 Wall Tile	6" x 18" (15.25 cm x 45.77 cm) 5/16"
	12 x 24 Wall Tile	12" x 24" (30.51 cm x 61.03 cm) 3/8"

MOSAICS	SIZES	THICKNESS
	2 x 2 Mosaic Dot-mounted	12" x 24" Sheet (30.48 cm x 60.96 cm Sheet) 1/4"
FLOOR TRIM		
	P43C9	3 x 12 Floor Bullnose
	P439B	3 x 15 Floor Bullnose
	P43F9	3 x 24 Floor Bullnose
WALL TRIM		
	S1/212J	12" Jolly

CORE FUNDAMENTALS™ – PLATINUM

AVAILABLE SIZE & TRIM SHAPES

PLATINUM

COLOR #	COLOR NAME	PAGE #	FLOOR										WALL			MOSAIC		
			FIELD TILE							BULLNOSE			FIELD TILE				JOLLY	
			15 x 30	24 x 24	12 x 24	12 x 12	8 x 48	6 x 36	6 x 24	P439B	P43C9	P43F9	12 x 24 Glossy	6 x 18 Glossy	4 x 12 Matte		S1/212J	2 x 2
AV17	White	21			●							●						
AV18	Beige	21			●							●						
AV19	Grey	21			●							●						
CT70	Magnolia	22		●	●	●						●		●		●	●	
CT71	Almond	22		●	●	●						●		●		●	●	
CT72	Dove	22		●	●	●						●		●		●	●	
CT73	Carbon	22		●	●	●						●		●		●	●	
CT74	Oyster	22			●							●		●		●	●	
CT75	Calacatta Sky	22			●							●		●	●	●	●	
CT76	Calacatta Empire	22		●	●	●						●		●	●	●	●	
HH01	Natural	23								●								
HH02	Greige	23								●								
HH03	Teak	23								●								
HH04	Dark Brown	23								●								
IT50	Chalk	21	●									●						●
IT51	Cliff	21	●									●						●
IT52	Shale	21	●									●						●
PH60	Cloud	23	●									●		●		●	●	
PH61	Mist	23	●									●		●		●	●	
PH62	Sand	23	●									●		●		●	●	
PH63	Smoke	23	●									●						●
RB10	Natural	23								●								
RB11	Brown	23								●								
RB12	Medium Gray	23								●								
RB13	Light Gray	23								●								
SL75	Alabaster	21			●								●					●
SL76	Jute	21			●								●					●
SL77	Quill	21			●								●					●
TH10	Loft	24					●											
TH11	Avenue	24					●											
TH12	Vintage	24					●											
TH13	Cavalry	24					●											
UB02	White	25			●								●					●
UB04	Grey	25			●								●					●
VL50	White	24								●								
VL51	Brown	24								●								
VL52	Dark Brown	24								●								
VL53	Gray	24								●								
VC01	White	24								●								
VC02	Natural	24								●								
VC03	Honey	24								●								
VC04	Brown	24								●								
VC05	Gray Brown	24								●								

CORE FUNDAMENTALS™ – PLATINUM

GLAZED PORCELAIN FLOOR AND GLAZED CERAMIC WALL & MOSAICS

PLATINUM: AV17, AV18, AV19 | HH01, HH02, HH03, HH04 | RB10, RB11, RB12, RB13 | TH10, TH11, TH12, TH13 | VL50, VL51, VL52, VL53 | VC01, VC02, VC03, VC04, VC05

APPLICATIONS

	Target DCOF wet	Suitable
Dry & Level – Interior Floor	N/A	✓
Wet & Level – Interior Floor	≥ 0.42	✓
Shower Floor – Standard Center Drain	≥ 0.42	
Shower Floor – Linear Drain	≥ 0.42	
Exterior Floor Applications (including patios, pool decking & other wet areas with minimal footwear)	≥ 0.60	
Ramps & Inclines	≥ 0.65	
Walls/Backsplashes	N/A	✓
Countertops	N/A	✓
Pool Linings	N/A	

A DCOF value of ≥0.42 is the standard for tiles specified for level interior spaces expected to be walked upon when wet, as stated in ANSI A137.1-A326.3. For more information about DCOF and the DCOF AcuTest™, visit daltille.com/DCOF.

APPLICATION NOTES:

Suitable for exterior applications (provided it is noted as suitable in the applications chart above) in freezing and non-freezing climates, when proper installation methods are followed.

INSTALLATION

Grout Joint Recommendation	Shade Variation
Floor: 3/16" (Overlap should not exceed 33% when installing tile with a length 15" or greater in a staggered brick-joint pattern.)	 High (V3)

PERFORMANCE CHARACTERISTICS

	ASTM#	Floor Result
Water Absorption	C373	< 0.5%
Breaking Strength	C648	> 275 lbf
Scratch Hardness	C1895	8.0
Chemical Resistance	C650	Resistant

For additional information on test results, visit us at: daltille.com/information/TestResults.

DURABILITY

Floor Surface Wear Resistance

1 Residential Bathrooms	3 All Residential / Light Commercial
2 All Residential Areas	④ All Residential / Commercial

PLATINUM: CT70, CT71, CT72, CT73, CT74, CT75, CT76 | PH60, PH61, PH62, PH63 | UB02, UB04 | SL75, SL76, SL77 | IT50, IT51, IT52 |

APPLICATIONS

	Target DCOF wet	Suitable
Dry & Level – Interior Floor	N/A	✓**
Wet & Level – Interior Floor	≥ 0.42	✓**
Shower Floor – Standard Center Drain	≥ 0.42	✓*
Shower Floor – Linear Drain	≥ 0.42	✓*
Exterior Floor Applications (including patios, pool decking & other wet areas with minimal footwear)	≥ 0.60	
Ramps & Inclines	≥ 0.65	
Walls/Backsplashes	N/A	✓
Countertops	N/A	✓**
Pool Linings	N/A	✓*

A DCOF value of ≥0.42 is the standard for tiles specified for level interior spaces expected to be walked upon when wet, as stated in ANSI A137.1-A326.3. For more information about DCOF and the DCOF AcuTest™, visit daltille.com/DCOF.



APPLICATION NOTES:

Suitable for exterior applications (provided it is noted as suitable in the applications chart above) in freezing and non-freezing climates, when proper installation methods are followed.

** Wall tile not suitable for this application

* Mosaic tile only

INSTALLATION

Grout Joint Recommendation	Shade Variation
Floor: 3/16" (Overlap should not exceed 33% when installing tile with a length 15" or greater in a staggered brick-joint pattern.)	 Medium (V2) PH60, PH61, PH62 & PH63
Wall: 1/16" (1/8" when rectangular size is installed in a staggered brick-joint pattern; overlap should not exceed 33%.)	 High (V3) CT70, CT71, CT72, CT73, CT74, CT75, CT76, UB02 & UB04, IT50, IT51, IT52, SL75, SL76 & SL77
Mosaic: 1/8"	

PERFORMANCE CHARACTERISTICS

	ASTM#	Floor Result	Wall Result	Mosaic Result
Water Absorption	C373	< 0.5%	< 20.0%	< 3.0%
Breaking Strength	C648	> 275 lbf	120-230 lbf	> 250 lbf
Scratch Hardness	C1895	8.0	4.0-6.0	8.0
Chemical Resistance	C650	Resistant	Resistant	Resistant

For additional information on test results, visit us at: daltille.com/information/TestResults.

DURABILITY

Floor Surface Wear Resistance

1 Residential Bathrooms	3 All Residential / Light Commercial
2 All Residential Areas	④ All Residential / Commercial





IMAGE DIRECTORY

COVER

Photo features Core Fundamentals™ Platinum Brown VC04 on the floor with One Quartz Surfaces® Freedom Calacatta OQ42 on the countertop.

PAGE 2

Photo features Core Fundamentals™ Prime White BA30 on the floor.

PAGE 3 – CHOICE

Photo features Core Fundamentals™ Choice Iron CS23 on the floor.

PAGE 3 – ADVANTAGE

Photo features Core Fundamentals™ Advantage Trumpet Grey EP22 on the floor with Aria White EP20 on the wall and Natural Stone Quartzite Slab Lamberti Bianco QO15 on the countertop.

PAGE 3 – PRIME

Photo features Core Fundamentals™ Prime Grey EL32 on the floor with Revalia™ Remix Radiant Blue RV33 on the wall.

PAGE 3 – PLATINUM

Photo features Core Fundamentals™ Platinum Mist PH61 on the floor and shower floor with Artcrafted™ Coconut AC23 on the shower walls and Panoramic Porcelain Surfaces™ Calacatta Aries CM21 on the countertop.

PAGE 4

Photo features Core Fundamentals™ Weathered White SQ20 on the floor with Shadow Grey SQ22 on the backsplash.

PAGE 8

Photo features Core Fundamentals™ Advantage Distressed Beige LS41 on the floor and shower floor with Mesmerist™ Allure MM33 on the shower walls and Natural Stone Slab Granite Colonial Gold G422 on the countertop and shower bench.

PAGE 13

Photo features Core Fundamentals™ Advantage Mural Taupe AQ02 on the floor with One Quartz Surfaces® Patriotic OQ47 on the countertop.

PAGE 14

Photo features Core Fundamentals™ Prime Historic Grey NS12 on the floor with Heirloom White NS10 on the wall and Natural Stone Granite Slab White River G848 on the countertop.

PAGE 22

Photo features Core Fundamentals™ Platinum Smoke PH63 on the floor with One Quartz Surfaces® Pulsar OQ61 on the countertop.

PAGE 25

Photo features Core Fundamentals™ Platinum Brown VC04 on the floor with One Quartz Surfaces® Freedom Calacatta OQ42 on the countertop.

BACK COVER

Photo features Core Fundamentals™ Platinum Calacatta Empire CT76 on the floor, shower floor and shower walls with Natural Stone Granite Slab Himalaya White G217 on the countertop.

