

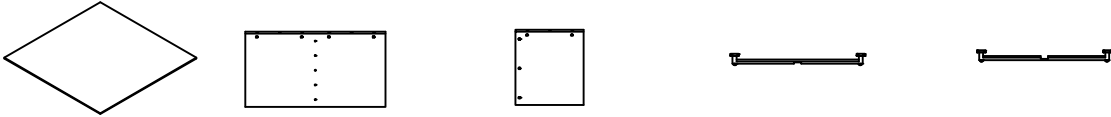







# 48" Square Conference Table ASSEMBLY INSTRUCTIONS

## COMPONENTS

- (A) Top Panel-1pc
- (B) Center Leg-1pc
- (C) End Leg-2pcs
- (D) Base Support-1  
-1pc
- (E) Base Support-2  
-1pc



## HARDWARE & TOOLS

- |  |  |   |  |  |
|--|--|---|--|--|
| <p>(F) Allen Screw<br/>M6X15mm-9pcs</p>       | <p>(G) Wood Dowel<br/>Ø8*30mm-9pcs</p>  | <p>(H) Cam Post-9pcs</p>         | <p>(I) Cam Lock-15pcs</p>          | <p>Tools Required for Assembly</p>  |
| <p>(J) Double Cam Post<br/>Ø6*84mm -3pcs</p>  | <p>(K) Cam Sticker-15pcs</p>            | <p>(L) Allen Wrench 4mm-1pc</p>  | <p>Philips Screw Driver for</p> <ul style="list-style-type: none"> <li>(H) Cam Post</li> <li>(I) Cam Lock</li> </ul> |  |

## INSTRUCTIONS - Do not use power tools to assemble

### STEP 1

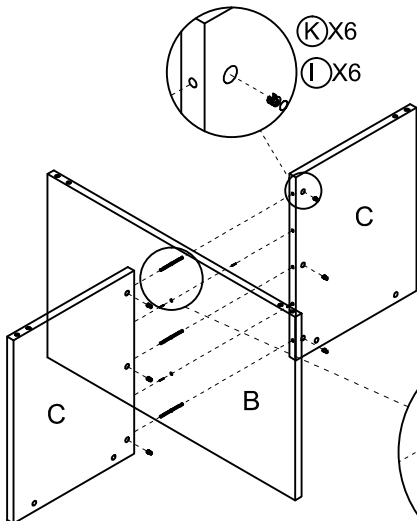

### STEP 2

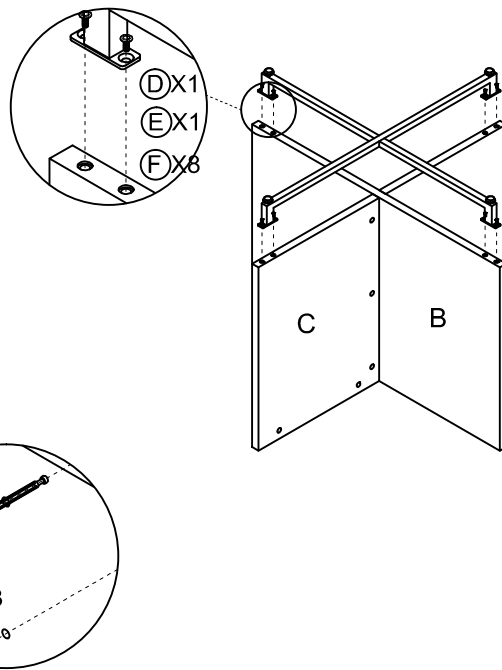

INSTRUCTIONS

STEP 3

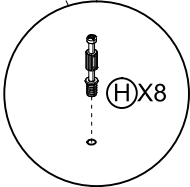
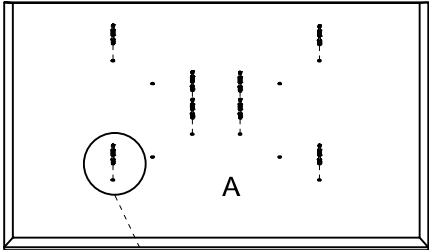

STEP 2

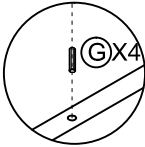
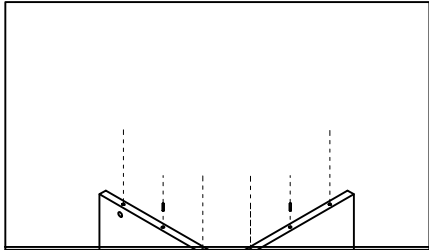

COMPLETED

