

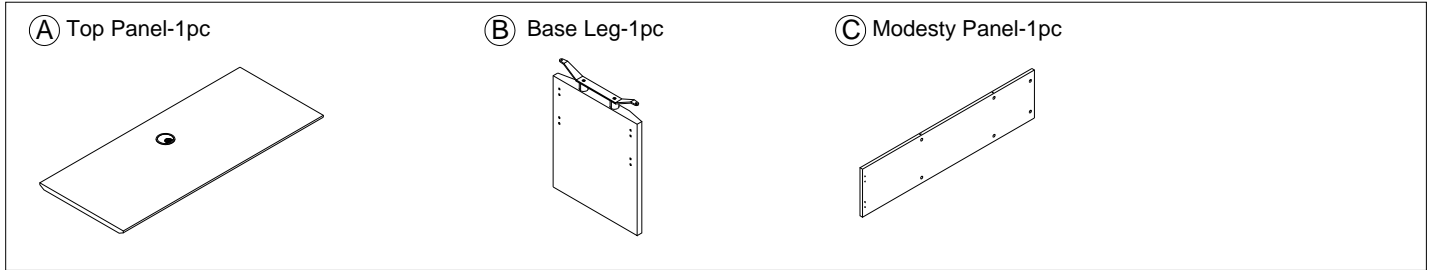











COMPONENTS



HARDWARE & TOOLS

(D) Mntg Bracket 150*90*3mm-2pcs	(E) Phillips Screw M6X15mm-13pcs	(F) Allen Screw M6X15mm-3pcs	(G) Allen Wrench 4mm-1pc	Tools Required for Assembly  Phillips Screw Driver for (E) Screw Ø6X15mm (I) Cam Post (K) Cam Lock (N) Screw Ø4X16mm
				
(H) Stand-off Ø20*90mm-2pcs	(I) Cam Post-5pcs	(J) Wood Dowel Ø8*30mm-3pcs	(K) Cam Lock-5pcs	
				
(L) Cam Sticker-11pcs	(M) Mntg Plate 80*50*9mm-2pcs	(N) Screw Ø4X16mm-9pcs		
				

NOTE:
Hardware is packed with carton **DRB**.

INSTRUCTIONS - Do not use power tools to assemble

STEP 1

STEP 2

INSTRUCTIONS

STEP 3

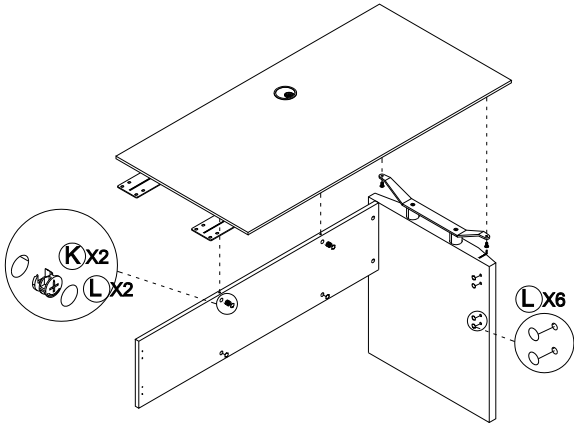

STEP 4

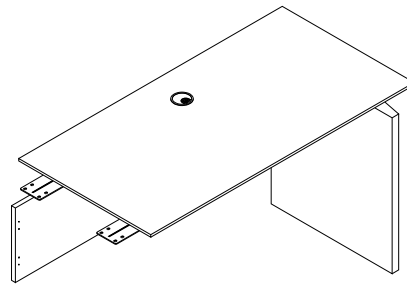

STEP 5 - Install Right or Left Side

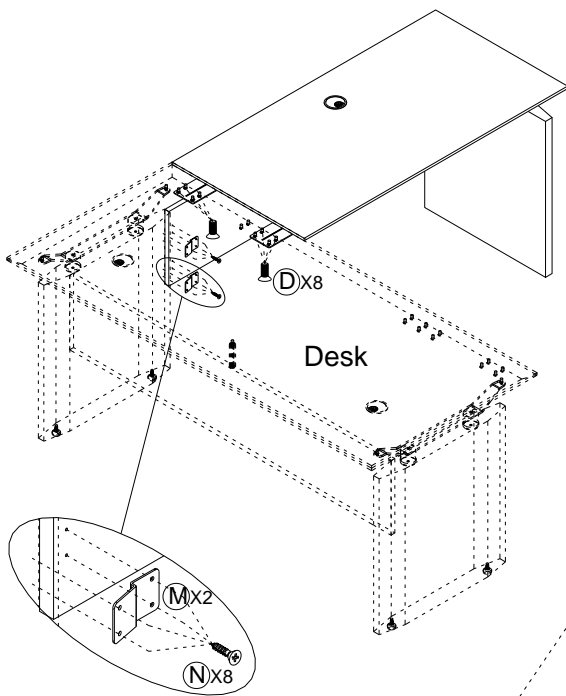

OR

