

# MODEL SM48

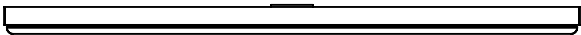

TOP VIEW

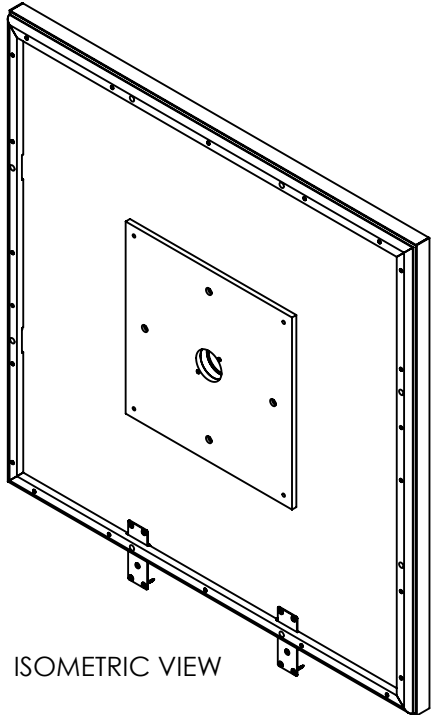

ISOMETRIC VIEW

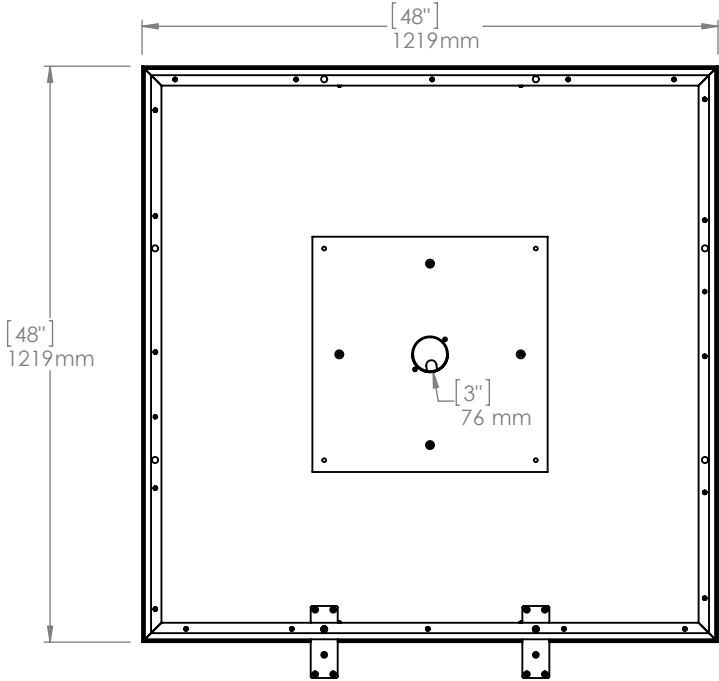

FRONT VIEW

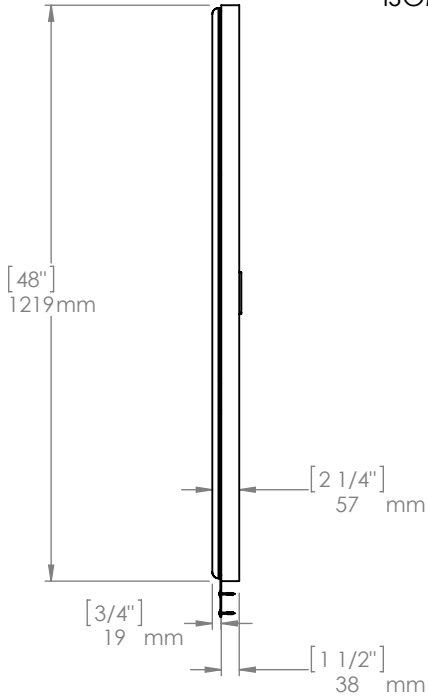

SIDE VIEW