

L A **Z** B O Y[®]

Designed to be comfortable,
and built to stay that way.

Live life Comfortably.[®]

Guest Chair Assembly Instructions

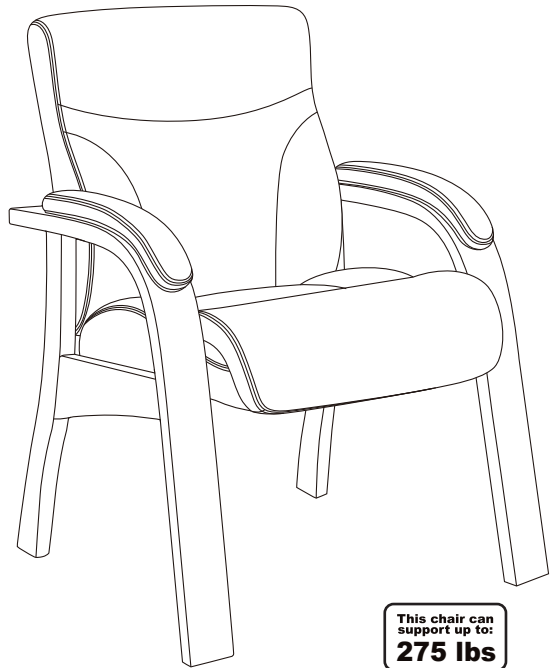

Model 49061S-A / 49061S-B

This chair can
support up to:
275 lbs

PARTS



(A1)

Right Wood Frame

Quantity: 1

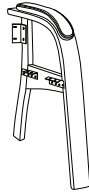

(A2)

Left Wood Frame

Quantity: 1

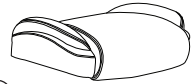

(B)

Seat Cushion

Quantity: 1

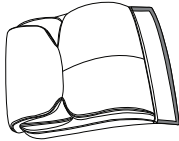

(C)

Back Cushion

Quantity: 1



(D)

1" Screws

Quantity: 12

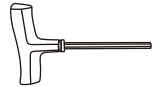

(E)

Allen Key

Quantity: 1

WARNINGS

1. This product should be used by only one person at a time.
2. Do not use this chair unless all bolts, screws and knobs are securely tightened.
3. **Save the hexagonal wrench.** Check that all bolts, screws and knobs are tight every three months or as needed.
4. Dispose of packing material properly. Do not use the plastic cover as a head covering. It may cause suffocation.
5. Do not use the chair as a stepladder.
6. To clean the product, use only a clean cloth. The use of chemicals or cleaning products may affect the color fastness.
7. Use this chair for its intended purpose only.

Step 1

Place the seat cushion (B) on top of a box prior to assembly. Align two wood frames (A1 & A2) over predilled holes on the underside of seat cushion (B). Fasten two frames to the bottom of seat cushion (B) (with the front of the metal brackets facing the front of seat cushion) by using 1" screws (D). Do not tighten screws completely.

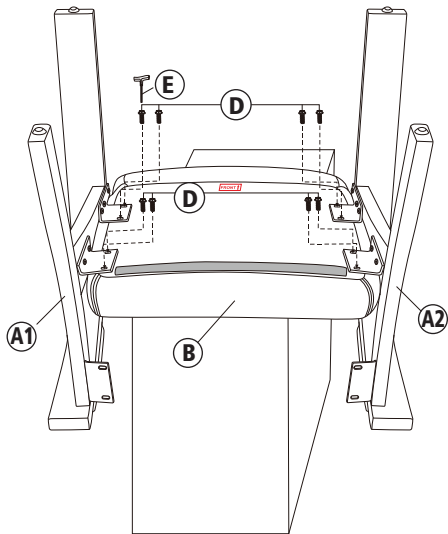

Step 2

Attach back cushion (C) to the wood frames (A1 & A2) by using 1" screws (D). Do not tighten screws completely. Adjust the chair so the seat and back cushions are aligned and the frame is sitting flat on the floor. Tighten all the screws. Pull down the back flap tightly and attach the back flap to the velcro on the bottom of the seat cushion (B).

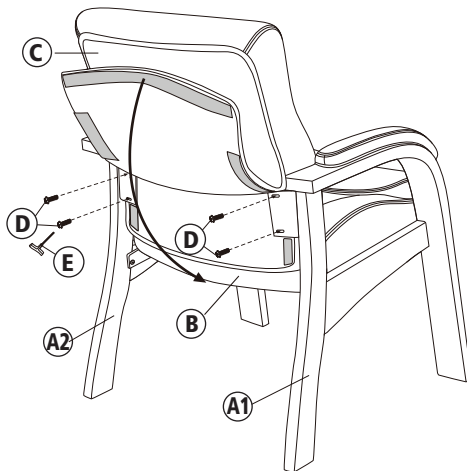

L A **Z** B O Y[®]

Live life Comfortably.[®]

