

Assembly Instructions  
**60" Desk**

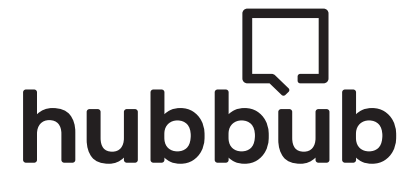

**Components**

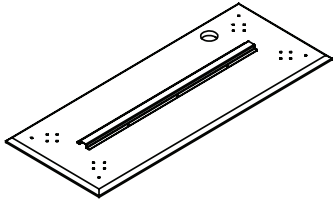

**A** Top panel (1)



**B** Legs (4)



**C** Charging station (1)

**Hardware/Tools**



**D** Screw M6\*20 (20)

**!** Tools Required  
for Assembly

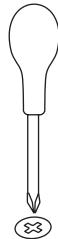

**Phillips Screwdriver**

**1**

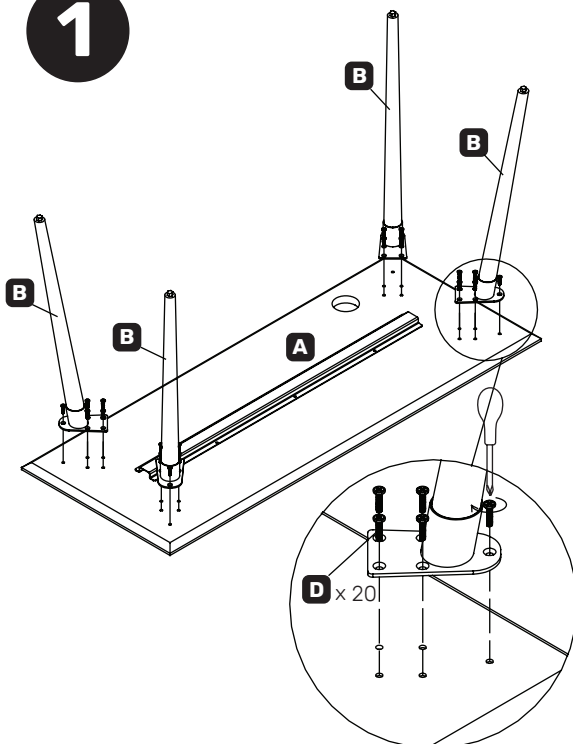

**2**

