

Congratulations on the purchase of your new *Signature Series* chair!

**PARTS**

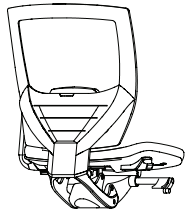

CHAIR BODY  
QTY: 1

MID-BACK VERSION

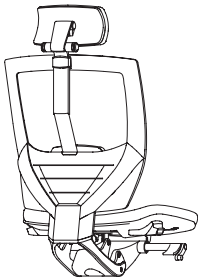

HIGH-BACK VERSION

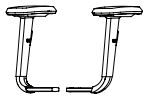

ARM RESTS  
QTY: 2



WIDTH  
ADJUSTABLE  
KNOB QTY: 2



SEAT LIFT  
QTY: 1

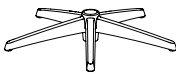

BASE  
QTY: 1



CASTERS  
QTY: 5



ALLEN WRENCH  
SPARE PART  
(SAVE FOR FUTURE  
TIGHTENING)

**CUSTOMER SERVICE HOTLINE**  
**800-626-6060**

**INSTRUCTIONS**

**Remove all parts from carton and verify part quantities as indicated on parts list.**

- ① Insert the caster into the hole at the bottom of the five prong base.
- ② Insert the bottom end of the seat lift into the center hole of the base.
- ③ Place the chair body onto the small end of the seat lift.
- ④ Insert armrests into the holes located at both sides of the seat. Insert the width-adjustable knobs into the holes from the underside of the seat. Adjust the width of the armrest to your preference, and tighten securely.

**Attention: MAKE SURE ALL SCREWS ARE FULLY TIGHTENED BEFORE USING CHAIR.**

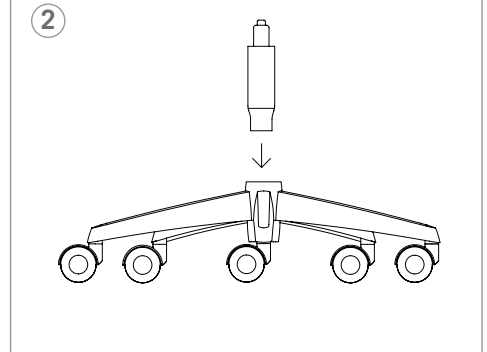
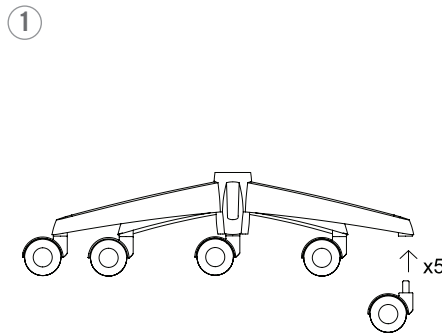

**Warnings**

1. This product should be used by only one person at a time.
2. Do not use this chair unless all bolts, screws and knobs are securely tightened.
3. **Save Allen wrench.** Check that all bolts, screws and knobs are tight every three months or as needed.
4. Dispose of packing material properly. Do not use the plastic cover as a head covering.  
It may cause suffocation.
5. Do not use the chair as a stepladder.
6. Use this chair for its intended purpose only.
7. Use a soft cloth to clean the chair. Do not use water or chemicals on the aluminum parts.

## ADJUSTMENTS

Push the button located on the bottom of the seat to slide the seat forward and backwards.

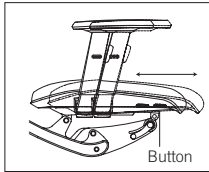

The backrest height can be manually adjusted by pulling up on the back of the chair.

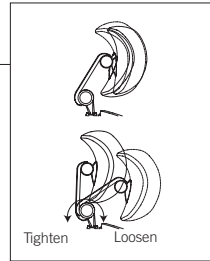
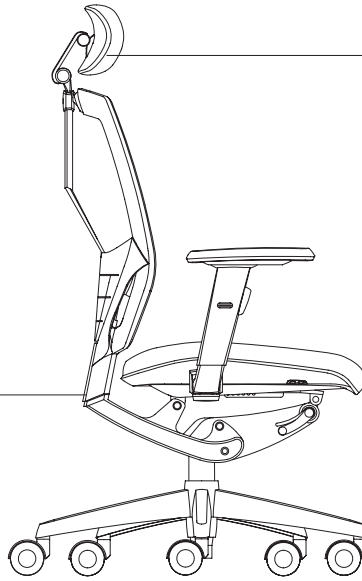
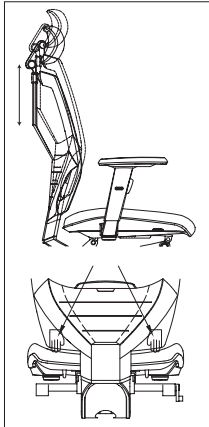

Rotate the knob to adjust the headrest angle.

The location, height, and width of the armrest can be adjusted manually.

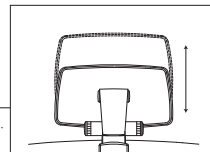
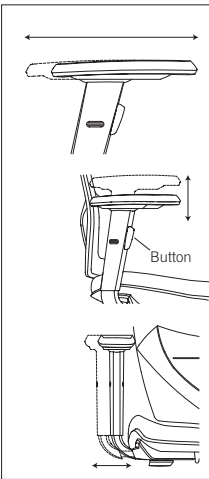

Manually pull up the headrest to adjust its height.

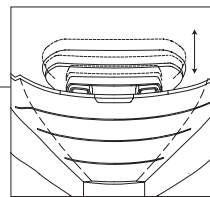

The back of the chair reclines with pressure and retracts automatically.

Turn the lever to lock/unlock the tilt motion.

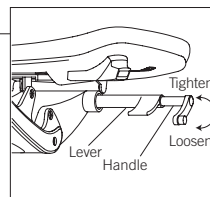
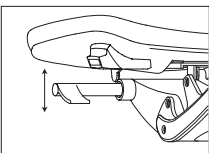

Turn the handle to adjust the strength of the back tilt tension.

Push the lever to adjust the chair height.