

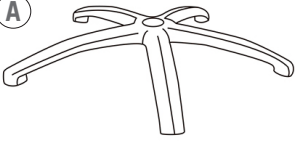

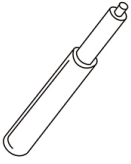
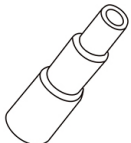

Congratulations on the purchase of your new *Signature Series* chair!

**PARTS:** Please remove all the parts from the carton and verify part quantities as indicated in this parts list.

ITEM	DESCRIPTION	QTY.
<b>A</b> 	Aluminum Base	1
<b>B</b> 	Gas Cylinder	1
<b>C</b> 	Telescopic Bellows	1
<b>D</b> 	Seat Back	1
<b>E</b> 	Seat Cushion with Mechanism	1
<b>F</b> 	Bolt	1
<b>G</b> 	Casters	5

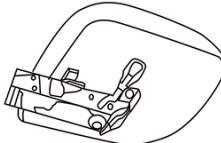

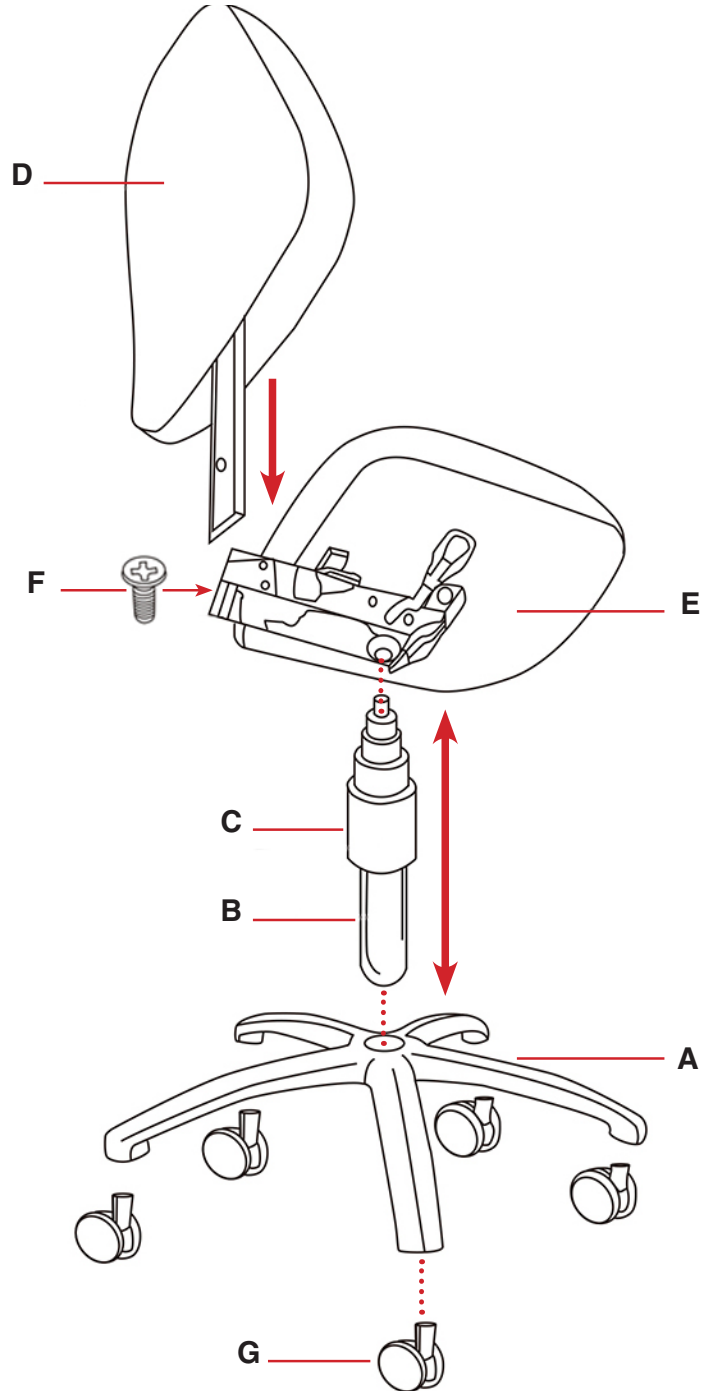
NB700

CUSTOMER SERVICE HOTLINE  
800-626-6060