



[www.centurybaby.com](http://www.centurybaby.com)

# Drive On™

## All-in-One Car Seat



century

### READ THIS INSTRUCTION MANUAL

Do not install or use this child restraint until you read, understand and follow the instructions in this manual and the warnings on the car seat.

**FAILURE TO  
PROPERLY USE THIS  
CHILD RESTRAINT  
INCREASES THE RISK  
OF SERIOUS INJURY  
OR DEATH IN A  
SUDDEN STOP OR  
CRASH.**

**KEEP INSTRUCTIONS FOR FUTURE USE.**

© Century Children's Products 2021 NWL0001209481D 2.21



## **1 Important**

*Pages 5-23*

---

- 1-A Quick Guide to Your Manual
- 1-B Welcome to the Century Family!
- 1-C Right Mode of Use
- 1-D Before You Begin
- 1-E Safety Warnings

## **2 Features**

*Pages 24-29*

---

## **3 Rear-Facing**

*Pages 30-45*

---

- 3-A Rear-Facing Use
- 3-B Install Rear-Facing With Lower Anchor Attachment
- 3-C Install Rear-Facing With Vehicle Seat Belt



# C

## **4 Forward-Facing**

---

*Pages 46-60*

4-A Forward-Facing Use

4-B Install Forward-Facing With LATCH

4-C Install Forward-Facing With Vehicle Seat Belt

## **5 Securing Child**

---

*Pages 61-72*

5-A Securing Child 5-Point Harness

5-B Removing Child

## **6 Booster**

---

*Pages 73-90*

6-A Booster Use

6-B Install Highback Booster

6-C Securing Child Highback Booster



## **7 Moving Lower Anchor Attachment**

---

*Pages 91-96*

## **8 Accessories**

---

*Page 97*

## **9 Vehicle Information**

---

*Pages 98-109*

- 9-A How to Uninstall Lower Anchor Connectors and Tether
- 9-B Choosing Vehicle Seat Location
- 9-C Unsafe Vehicle Seat Locations
- 9-D Vehicle Seat Belts

## **10 Care & Cleaning**

---

*Pages 110-117*

- 10-A Cleaning Seat Pad
- 10-B Cleaning Buckle
- 10-C Cleaning Harness, Lower Anchor Attachment and Tether





## *This car seat is for children:*

***Rear-Facing: 5-40 lb (2.2-18 kg)***

***Forward Facing: 22-65 lb (10-30 kg)***

***Booster: 40-100 lb (18.1-45 kg) and at least 4 years old***

- Children less than 22 lb (10 kg) **MUST** use this car seat rear-facing. Review section 1-C for more information.

**Note:** Preterm or low birth weight infants may be at special risk in a vehicle or aircraft. According to the AAP, these infants may suffer breathing issues if improperly reclined in a car seat. When rear-facing, use the corrected age for preemies. Century advises that you have your physician or hospital staff evaluate your infant and recommend the proper car seat or car bed before you and your infant leave the hospital.

## Install Cup Holders

### Adult Assembly Required

The cup holders must be installed. To attach the cup holders, match the right cup holder to the right side of the seat and the left to the left. Slide the hook on the cup holder into the slot in the seat, then rotate the bottom of the cup holder down until you hear a “Click”. **You will hear a “Click” when they are secured in place.**

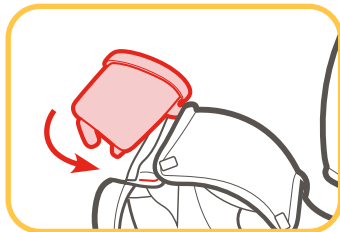
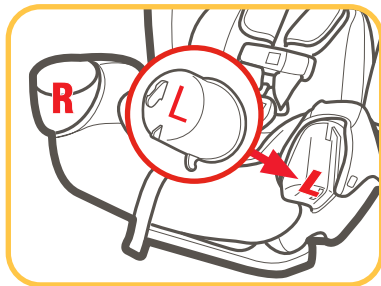
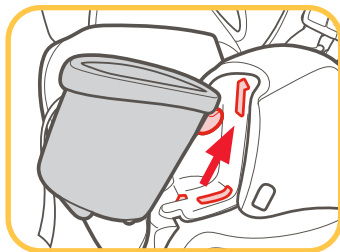

### ***Get to Know Your Car Seat***

Review section 2-A to see all of the features of this car seat.

### ***What Seating Location Should I Use?***

#### ***The best seating location for this car seat is one that:***

- Is recommended by your vehicle owner's manual.
  - Results in a secure installation of this car seat.
- Some vehicles have specific requirements for where the car seat can be installed, so be sure to check your vehicle owner's manual for available seating positions, if any.

Review section 9-B, 9-C, 9-D of this manual AND your vehicle owner's manual.

According to accident statistics, children are safer when properly restrained in the rear seating positions than in the front seating positions. The center of the back seat can be the safest during a possible side impact.



### *Which Installation Method Should I Use?*

This car seat can be installed in your vehicle using either the vehicle seat belt **OR** the lower anchor attachment. Both are equally safe to use. **INSTALL USING ONLY ONE METHOD.** Century allows the securing of the car seat with the LATCH system in the booster mode, only if the vehicle manufacturer allows it. The child still **MUST BE SECURED** with the vehicle lap/shoulder seat belt.

**Vehicle Seat Belt:** Review section 9 and your vehicle owner's manual to learn how to install your car seat with the vehicle seat belts.

**LATCH or Lower Anchor Attachment:** The LATCH system or lower anchor attachment allows you to securely attach your safety seat in your car without using the vehicle seat belt and possibly to get a better fit. All 2003 and newer model year vehicles are required to have LATCH, although some manufacturers began including LATCH earlier. Some vehicle owner manuals use the term ISOFIX to identify the LATCH system.

## What is LATCH?

LATCH consists of lower anchors and a tether anchor, which are built into your vehicle, and a lower anchor attachment and tether that are built into your car seat. The lower anchor attachment is used **INSTEAD** of the vehicle's seat belt to secure the child seat to the vehicle. The tether is used **IN ADDITION** to the lower anchor attachment **OR** the vehicle's seat belt to secure a forward-facing car seat to the vehicle.

**Review your vehicle's owner manual for exact location and use.**

**Vehicle Tether  
Anchor**

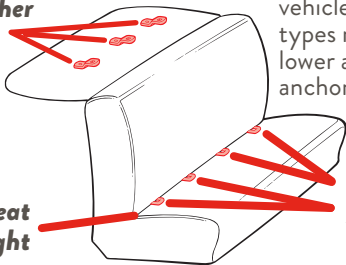

**Vehicle Seat  
Bight**

**Vehicle Lower  
Anchor**



Typical seat in a passenger vehicle. Other vehicle types may have different lower anchor and tether anchor locations.

## When Installing Rear-Facing or Forward-Facing

### Lower Anchor Attachment

The Lower Anchor Attachment consists of lower anchors, which are built into your vehicle, and lower anchor connectors that are built in your car seat. Review section 3-B & 4-B of this manual AND your vehicle owner's manual before installing.

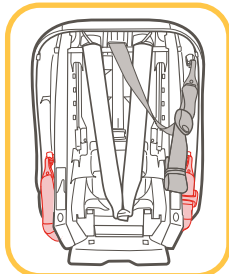
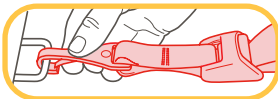

### Vehicle Seat Belt

There are two types of vehicle seat belts that can be used when installing rear-facing & forward-facing. Lap/shoulder seat belt or lap only seat belt. Review section 3-C, 4-C & 9 of this manual AND your vehicle owner's manual.

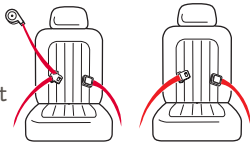

## When Installing as a Booster

### Vehicle Seat Belt

Only use the Lap/Shoulder seat belt configuration when installing as a booster. Review section 6-B, 6-C, and 9 of this manual AND your vehicle owner's manual.

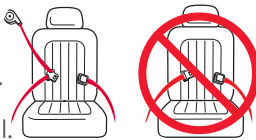

## Does Your Car Seat Fit Your Child Correctly?

To make sure your child is secured properly, review section 3, 4, 5 & 6 to understand all of the actions you need to take to properly adjust the car seat to fit your child.

### For Rear-Facing and Forward-Facing, You Need to Adjust:

#### **Harness Height, Rear-Facing**

(A) Harness straps at or just below the child's shoulders (B) and top of head **must** be at least 1" (2.5 cm) below the headrest adjustment lever. Review section 5.

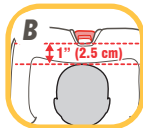

#### **Harness Height, Forward-Facing**

(C) Harness straps at or just above the child's shoulders (D) and top of child's ears below top of headrest. Review section 5.

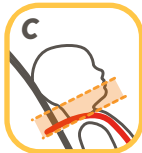

#### **Buckle Position (E)**

The correct slot is the one that is closest to your child without being underneath them. Review section 5.



#### **Harness Tightness (F)**

If your fingers slide off the harness straps without pinching the straps, it is tight enough. Review section 5.

### *For Booster, You Need to Adjust:*

#### **Use Lap/Shoulder Belt Only**



#### **Position Lap Belt**

Lap belt must go behind armrest and lie low across your child's hips and thighs.

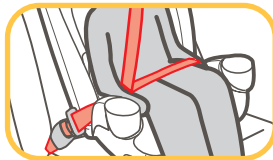

#### **Position Shoulder Belt**

Shoulder belt lies across shoulder between neck and edge of shoulder.





**Did You Do Everything Correctly?****Rear-Facing Installation**

**Car Seat Does Not Move More than 1" (2.5 cm) at the Belt Path (A)**

Review section 3

**Check Level Line (B)**

Review section 3

**Harness Straps at or Just Below Child's Shoulders (C)**

Review section 5

**Chest Clip Even With Armpits (D)**

Review section 5

**Cannot Pinch Harness Straps at the Shoulder (E)**

Review section 5

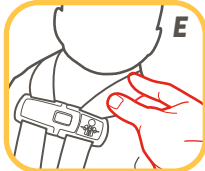
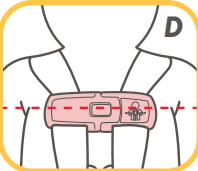
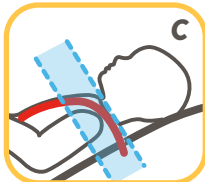
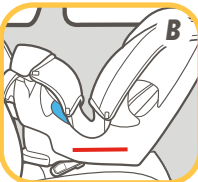
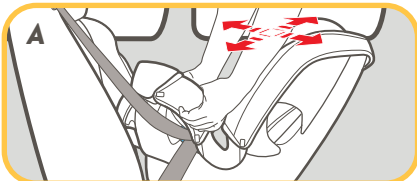

## Forward-Facing Installation

### **Use the tether strap when using forward-facing (A)**

When used properly, the tether helps reduce injury in a sudden stop or crash. Review section 4



### **Car Seat Does Not Move More than 1" (2.5 cm) at the Belt Path (B)**

Review section 4

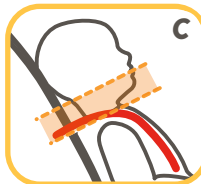
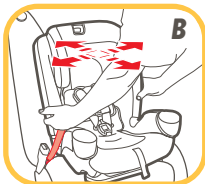

### **Harness Straps at or Just Above Child's Shoulders (C)**

Review section 5

### **Chest Clip Even With Armpits (D)**

Review section 5

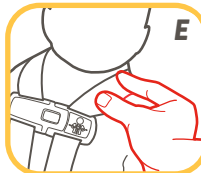
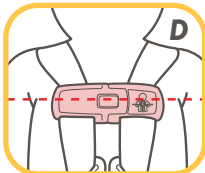

### **Cannot Pinch Harness Straps at the Shoulder (E)**

Review section 5

## **Booster Installation**

### **Never Use Lap Belt Only**

Review section 6



### **Lap Belt Behind Armrest and Lies Low Across Hips and Thighs**

Review section 6

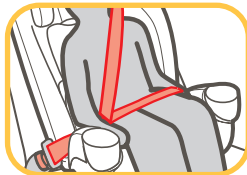

### **Shoulder Belt Lies On the Shoulder, Between the Neck and Edge of Shoulder**

Review section 6





1

## 1-B | Welcome to the Century Family!



Your child's safety depends on you. No car seat can guarantee protection from injury in every situation, but proper use helps reduce the risk of serious injury or death.

Even if this car seat seems easy to figure out on your own, you must follow the detailed instructions in this instruction manual to ensure all steps are preformed correctly.

**Visit: [www.centurybaby.com/safety](http://www.centurybaby.com/safety) for more information about Century's car seat safety standards.**



# 1-C | Right Mode of Use

1

5 lb  
(2.2 kg)

22 lb  
(10 kg)

40 lb  
(18 kg)

65 lb  
(30 kg)

100 lb  
(45 kg)

## Rear-Facing with 5-Point Harness

Must be 49" (125 cm) or less:  
5-22 lb (2.2-10 kg) less than 1 year old **MUST** be rear-facing. 22-40 lb (10-18 kg) **SHOULD** be rear-facing.\*

## Forward-Facing with 5-Point Harness

Must be 49" (125 cm) or less: 22-40 lb (10-18 kg) can sit upright unassisted **CAN** be forward-facing. 40-65 lb (18-30 kg) **SHOULD** be forward-facing.\*

## Booster Mode with Vehicle Lap/Shoulder Seat Belt

Must be 43-57" (110.1-145 cm) tall and 4+ years old. 40-65 lb (18.1-30 kg) **CAN** be in booster mode. Over 65 lb (30 kg) **MUST** be in booster mode.\*

\* Check your local and state laws and the AAP/NHTSA recommendations. See page 22.

**1****1-D | Before You Begin****C****Register This Child Restraint**

Please fill out the prepaid registration postcard attached to the harness and mail it in today **or register online at:**

**[www.centurybaby.com/carseatregistration](http://www.centurybaby.com/carseatregistration)**

Child restraints could be recalled for safety reasons. You must register this restraint to be reached in a recall. Send your name, address, and the restraint's model number and manufacturing date to:

Century Children's Products

Attn: Customer Service

P.O. Box 169, Elverson, PA 19520-9901

or call 1-844-385-0249

**or register online at**

**[www.centurybaby.com/carseatregistration](http://www.centurybaby.com/carseatregistration)**

For recall information, call the U.S. Government's Vehicle Safety Hotline at 1-888-327-4236 (TTY: 1-800-424-9153), or go to <http://www.NHTSA.gov>.

For future reference or if you change addresses, record the model name, model number, date of manufacture, and purchase date of this car seat below. You can find this information either on the registration card if you still have it or on the date label located on the back of the car seat.

**Model Name** \_\_\_\_\_

**Model Number** \_\_\_\_\_

**Date of Manufacture** \_\_\_\_\_

**Date of Purchase** \_\_\_\_\_

### ***If You Need Help***

In the U.S.A, please contact our Customer Service Department with any questions you may have concerning parts, use, or maintenance. When you contact us, please have your product's model number and date of manufacture ready so that we may help you efficiently. These numbers can be found on a sticker on the back side of your car seat.

For additional resources or to get your car seat checked by a child passenger safety technician, please visit the following web sites:

[www.nhtsa.gov](http://www.nhtsa.gov) • [www.seatcheck.org](http://www.seatcheck.org) • [www.safekids.org](http://www.safekids.org)

## Certification

This child restraint meets or exceeds all applicable requirements of Federal motor vehicle safety standard 213 for use in motor vehicles.



This child restraint is certified for use in aircraft only when used with the internal harness system. Use only on forward-facing aircraft seats. Follow the instructions for vehicle installation. For rear-facing installation, see section 3-C and 9-D Lap Belt Installation. For forward-facing installation, see section 4-C and 9-D Lap Belt Installation, but do not use tether. Contact the airline for their specific policies.



This child restraint is not certified for aircraft use when used as a booster seat because aircrafts do not have shoulder belts. Contact the airline for their specific policies.

## Car Seat's Useful Life

**DO NOT** use this child restraint in harnessed mode 7 years after the date of manufacture, or in booster mode 10 years after the date of manufacture. Look for date of manufacture label on back of the car seat.

Century Children's Products advises against loaning or passing along a car seat unless you know the complete history of the product. We also advise against purchasing a car seat second hand.

## Vehicle Seat Protection

Protect vehicle seat. Use a car seat mat, towel, or thin blanket under and behind car seat.

## Warm Weather Use

Car seat parts can get very hot in the sun or warm weather. **To avoid burns, always check before putting child in car seat.**





## 1-E | Safety Warnings

1

**No car seat can guarantee protection from injury in every situation, but proper use helps reduce the risk of serious injury or death.**

**READ THIS MANUAL CAREFULLY.**

### **! WARNING!**

Failure to follow these instructions and child restraint's labels can result in child striking the vehicle's interior during a sudden stop or crash.



**! NEVER PLACE THIS CHILD RESTRAINT REAR-FACING IN A VEHICLE SEATING LOCATION THAT HAS AN ACTIVE FRONT AIR BAG.**

If an air bag inflates, it can hit the child and car seat with great force and cause serious injury or death to your child.

**! Review your vehicle owner's manual for more information about air bags and car seat use.**

**! If your vehicle does not have a back seat, review your vehicle owner's manual.**

**! Children are safer riding rear-facing and should ride rear-facing as long as possible, until they reach the maximum rear-facing height or weight rating for their car seat. Then children should ride forward-facing, using the built in harness system for as long as possible until they reach the maximum forward-facing weight or height for their car seat. At that point, children should ride in a belt-positioning booster seat. A booster is no longer needed once the vehicle seat belt fits properly, typically when they reach 4 feet 9 inches (145 cm) tall and are between ages 8-12 years old. Be sure to check your local and state laws, as well as AAP and NHTSA recommendations, for car seat usage.\***

**! Choose the correct mode of use for the car seat depending on your child's size. Infants less than 22 lb. (10 kg) MUST use this car seat rear-facing.**

**! Select a suitable location for the car seat in your vehicle.**

**! Secure car seat with a vehicle seat belt or the lower anchor attachment that is properly routed as shown in this manual.**

**! Vehicle seat belt system MUST hold car seat securely. Not all vehicle seat belts can be used with a car seat.**

**! If vehicle seat belt does not hold car seat securely, read "Vehicle Seat Belts" section 9-D and your vehicle owner's manual.**

\*Century Supports the American Academy of Pediatrics and National Highway Traffic Safety Administration's Car Seat Guidelines. Visit [www.centurybaby.com/safety](http://www.centurybaby.com/safety) for information on car seat usage recommendations.

**! Always secure car seat with the lower anchor attachment or a vehicle seat belt, even when unoccupied. In a crash, an unsecured car seat can injure passengers.**

**! If car seat is in a crash, it must be replaced. DO NOT use it again! A crash can cause unseen damage and using it again could result in serious injury or death.**

**! DO NOT use car seat if it is damaged or missing parts.**

**! DO NOT use accessories or parts other than those provided by Century except for a thin towel or mat to protect your vehicle seat or rolled towels or pool noodles to help get your car seat level. Their use could alter the performance of the car seat.**

**! DO NOT remove LATCH system from car seat. If using vehicle seat belt to secure car seat, lower anchor hooks must be stored.**

**! Never leave child unattended, even when sleeping. Child may become tangled in harness straps and suffocate or strangle.**

**! Rear-facing car seat must be properly leveled:**

• Too reclined can result in injury or ejection.

• Too upright can result in breathing difficulties.



**! Never attach two lower anchor connectors to one vehicle lower anchor unless specifically allowed by the vehicle manufacturer.**

**! Do not use both the vehicle seat belt and lower anchor attachment at the same time when using the car seat rear or forward facing with the 5-point harness.**

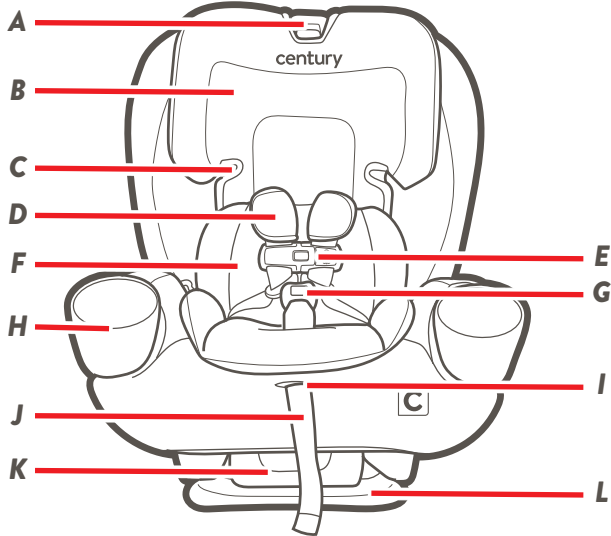

**C****2**

- A** Headrest/Harness Height Adjustment Lever
- B** Headrest
- C** Booster Shoulder Belt Guide
- D** Harness Covers
- E** Chest Clip
- F** Body Support
- G** Buckle
- H** Cup Holders
- I** Harness Adjustment Lever (under seat pad)
- J** Harness Adjustment Strap
- K** Recline Handle
- L** Recline Foot
- M** Harness Storage Compartment
- N** Harness Straps
- O** Buckle Tongues
- P** Buckle Strap

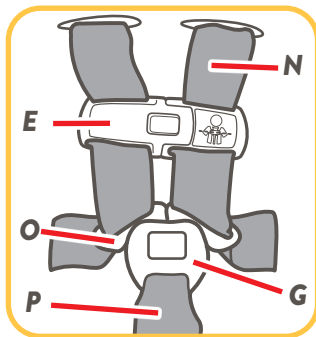
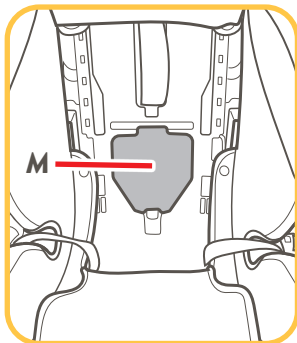

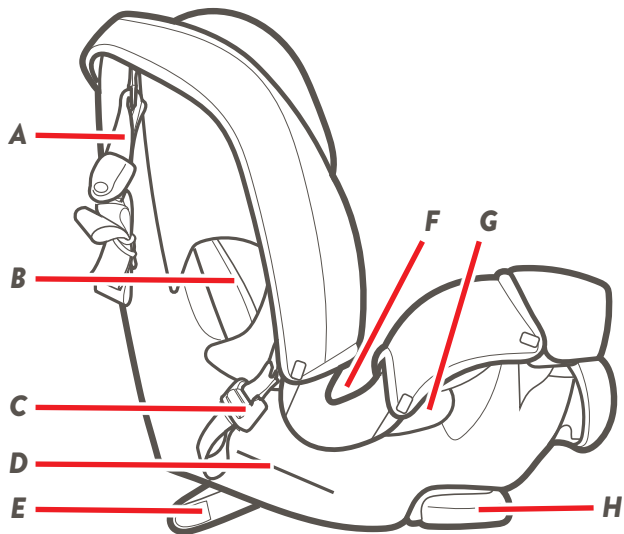



**C**

- A Tether Strap**
- B Forward-Facing Belt Path**
- C Lower Anchor Attachment**
- D Level Line**
- E Flip Foot**
- F Booster Lap Belt Path**
- G Rear-Facing Belt Path**
- H Recline Foot**

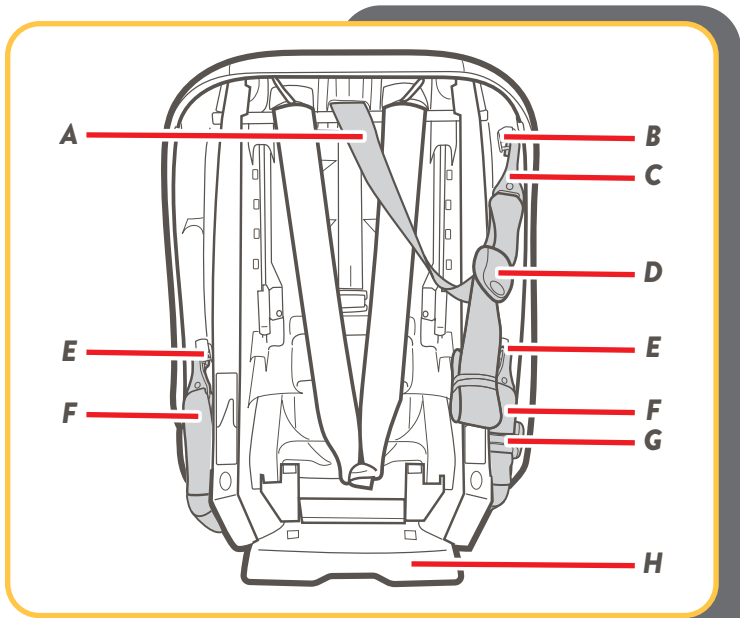



**C****2**

- A Tether Strap**
- B Tether Storage Bar**
- C Tether Hook**
- D Tether Adjuster**
- E Lower Anchor Connector Storage**
- F Lower Anchor Strap**
- G Lower Anchor Adjuster**
- H Instruction Manual Storage**  
*(Inside flip foot)*

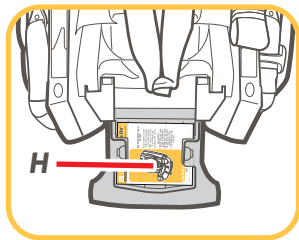

# 3 3-A | Rear-Facing Use

C

**Rear-Facing: 5-40 lb (2.2-18 kg) and whose top of head is at least 1" (2.5 cm) below the headrest adjustment handle**



- Infants who weigh less than 22 lb (10 kg) **MUST** be rear-facing.
- Place car seat rear-facing in the vehicle back seat.
- Make sure the lower anchor strap or vehicle seat belt is routed through the rear-facing belt path marked with a blue label.
- Install this car seat tightly in your vehicle. Car seat **should not move** at the rear-facing belt path more than 1" (2.5 cm) from side to side, front to back.
- Check the level line for proper recline. The line should be level with the ground.
- Harness straps need to be **at or just below** the top of child's shoulders and chest clip is at **armpit level**.
- Recheck the Level Line with child in seat.

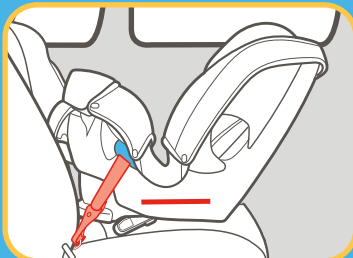

**Lower Anchor Attachment**

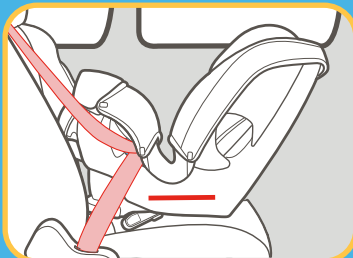

**Vehicle Lap/Shoulder Seat Belt**

Visit [www.centurybaby.com](http://www.centurybaby.com) and the Century™ Drive On™ car seat product page to view installation videos.

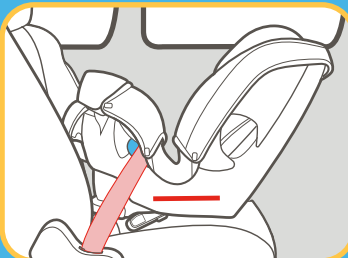

### Vehicle Lap Only Seat Belt

**Note:** Preterm or low birth weight infants may be at special risk in a vehicle or aircraft. According to the AAP, these infants may suffer breathing issues if improperly reclined in a car seat. Century advises that you have your physician or hospital staff evaluate your infant and recommend the proper car seat or car bed before you and your infant leave the hospital.

• Children are safer riding rear-facing and should ride rear-facing as long as possible, until they reach the maximum rear-facing height or weight rating for their car seat. Then children should ride forward-facing, using the built in harness system for as long as possible until they reach the maximum forward-facing weight or height for their car seat. Be sure to check your local and state laws, as well as AAP and NHTSA recommendations, for car seat usage.

### **! WARNING!**



**NEVER**  
place this  
child restraint  
rear-facing  
in a vehicle  
seating location that  
has an active front  
air bag.

# 3 3-B | Install Rear-Facing With Lower Anchor Attachment

C

*Review your vehicle owner's manual for lower anchor location and use.*

## 1. Store Tether

Attach tether hook to the plastic bar on right side of the car seat.

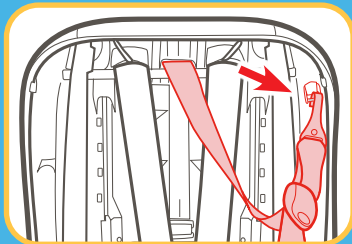

## 2. Remove Lower Anchor Connectors from Storage Location

Unhook the lower anchor connectors and remove from storage position.

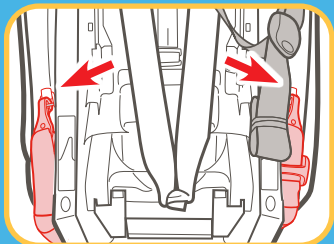

## 3. Make Sure Lower Anchor Strap is in the Rear-Facing Belt Path Marked With a Blue Label

If not, see section 7 to move lower anchor attachment.

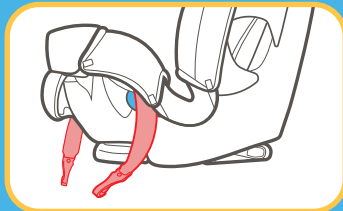

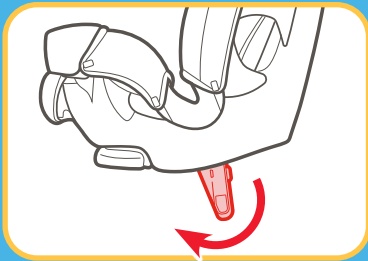

#### 4. Rotate The Flip Foot

Rotate the flip foot on the bottom of the car seat into the rear-facing position marked with a blue label. The blue arrow must be pointing up. The flip foot is secure when it “clicks” into place.

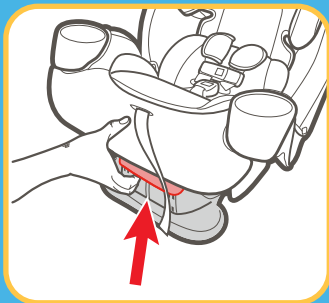
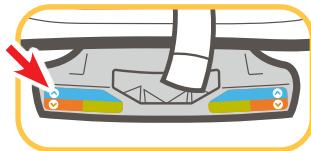

#### 5. Recline the Car Seat

Squeeze the lever on front of car seat and adjust to one of the three rear-facing positions.

## 6. Place Car Seat Rear-Facing in Back Seat of the Vehicle

Place rear-facing in vehicle seat and center the car seat between the lower anchors. The bottom of the seat and flip foot should sit as flat as possible on the vehicle seat.

## 7. Make Sure Base is a minimum of 80% on Vehicle Seat.



## 8. Check the Level Line

The level line on the side of the seat **MUST BE LEVEL** with the ground. If needed, rolled towels may be placed under the car seat at the vehicle seat crease, until the level line is level with the ground.

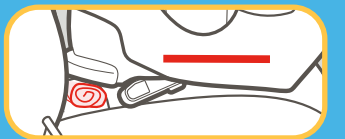
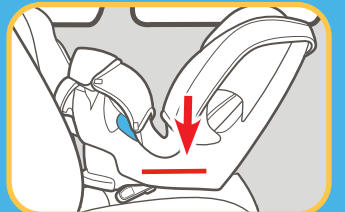
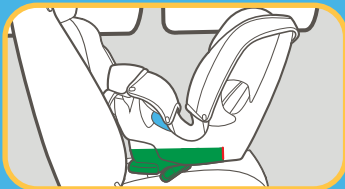

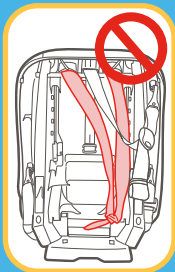
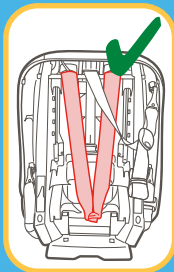

### 9. **Check the Harness Position**

Check the harness position in the back of seat. It should be positioned in the center of the seat, and not shifted to one side.

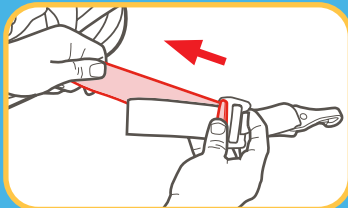

### 10. **Extend the Lower Anchor Strap**

For easier installation, extend the lower anchor strap to its maximum length by pressing the grey button and pulling on the strap.

### 11. Connect the Lower Anchor Connectors to the Vehicle's Lower Anchors

Lower anchor strap should lay as flat as possible and not be twisted. If the strap is twisted, you will not be able to tighten the strap. Do not attach the hook upside down.

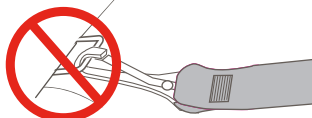
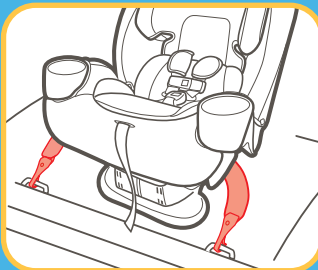
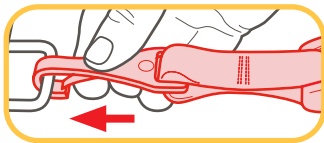

### 12. Tighten the Lower Anchor Strap

Press down firmly in the center of the car seat while tightening the lower anchor strap to remove all the slack.

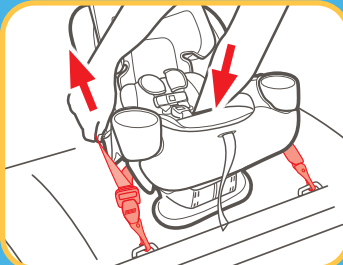



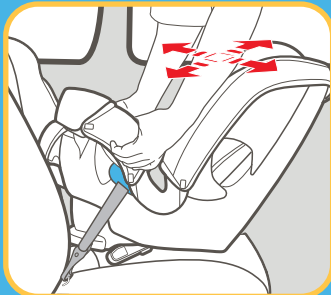

### 13. Test For Tightness

Grab the sides of the seat where the lower anchor strap is and slide the car seat side-to-side and front-to-back. If the seat moves less than 1" (2.5 cm), it is tight enough.

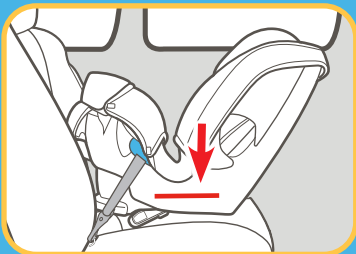

### 14. Check the Level Line

The level line on the side of the seat **MUST BE LEVEL** with the ground.

If needed, rolled towels may be placed under the car seat at the vehicle seat crease, until the level line is level with the ground.

**See section 5 to secure your child.** Recheck the level line with child in the car seat.

# 3 Is Everything Correct?

C

**Car Seat Does Not Move More than 1" (2.5 cm) at the Belt Path**

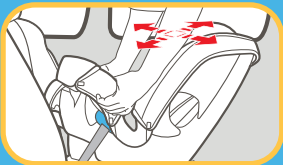

**Harness Straps at or Just Below the Child's Shoulders**

Review section 5

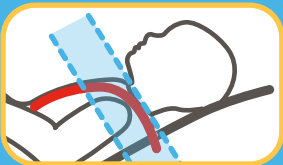

**Level Line is Level with the Ground**

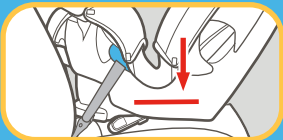

**Cannot Pinch Harness Straps at the Shoulder**

Review section 5



**Chest Clip Even With Armpits**

Review section 5

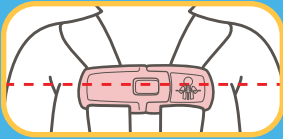

*See section 9-D for additional vehicle seat belt  
installation information*

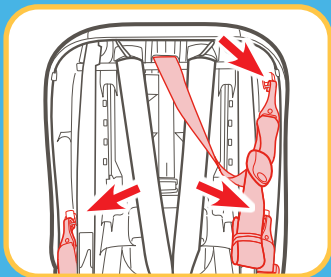

### **1. Store Tether Strap and Lower Anchor Connectors**

Attach tether hook and lower anchor connectors to the plastic bars as shown.

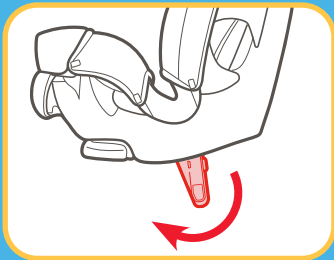

### **2. Rotate The Flip Foot**

Rotate the flip foot on the bottom of the car seat into the rear-facing position marked with a blue label. The blue arrow must be pointing up. The flip foot is secure when it “clicks” into place.

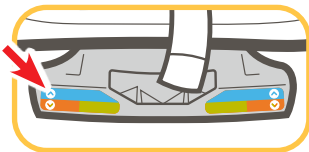

### 3. Recline the Car Seat

Squeeze the lever on front of car seat and adjust to one of the three rear-facing positions.

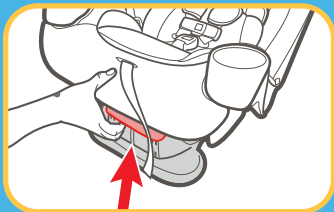

### 4. Place Car Seat Rear-Facing in Back Seat of the Vehicle

Place rear-facing in vehicle seat. The bottom of the seat and flip foot should sit as flat as possible on the vehicle seat.

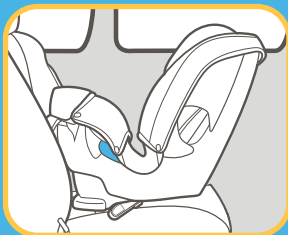

### 5. Make Sure Base is a minimum of 80% on Vehicle Seat.

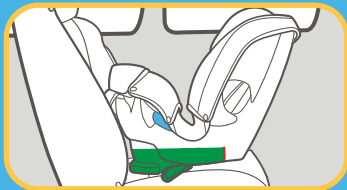

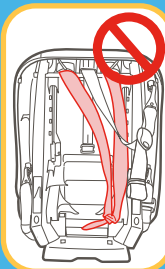
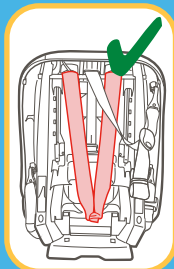
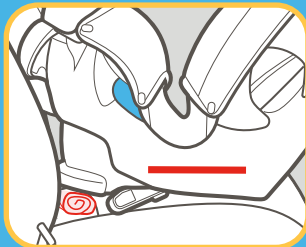
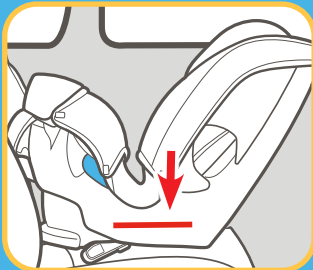

## 6. Check the Level Line

The level line on the side of the seat **MUST BE LEVEL** with the ground. If needed, rolled towels may be placed under the car seat at the vehicle seat crease, until the level line is level with the ground.

## 7. Check the Harness Position

Check the harness position in the back of seat. It should be positioned in the center of the seat, and not shifted to one side.

**Review your vehicle's owner manual for vehicle seat belt use**

**8. Route the Vehicle Seat Belt Through the Rear-facing Belt Path**

Thread vehicle seat belt through the rear-facing belt path (marked with a blue label) and out the other side. Buckle the seat belt. The seat belt should lie as flat as possible and not be twisted.

**Note:** Make sure the vehicle seat belt is in front of the buckle strap when the buckle is in the inner-most position (**A**), and behind when in the outer-most position (**B**).

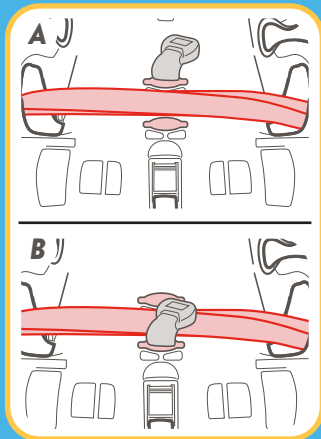
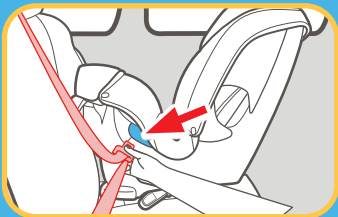

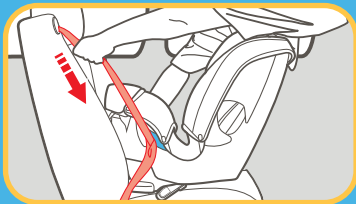

### **9. Lock Vehicle Seat Belt**

In most vehicles today, slowly pull the shoulder belt all the way out and then let it go back in. You will hear a clicking sound. Slowly pull out on the belt and it should be locked. If not, review your car's owner manual and section 9-D.

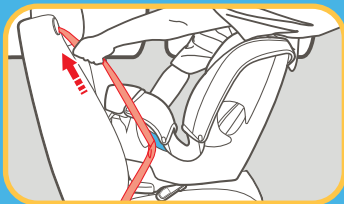

### **10. Tighten the Vehicle Seat Belt**

Press down firmly in the center of the car seat. Pull on the shoulder belt to tighten while feeding the slack back in the retractor.

### 11. Test For Tightness

Grab the sides of the seat where the vehicle seat belt is and slide the car seat side-to-side and front-to-back.

If the seat moves less than 1" (2.5 cm), it is tight enough.

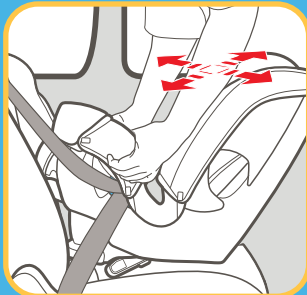

### 12. Check the Level Line

The level line on the side of the seat **MUST BE LEVEL** with the ground.

If needed, rolled towels may be placed under the car seat at the vehicle seat crease, until the level line is level with the ground.

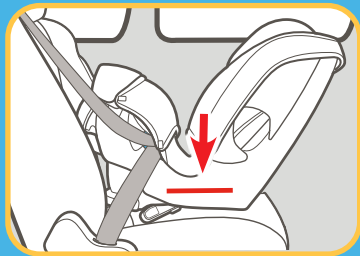

**See section 5 to secure your child.** Recheck the level line with child in the car seat.



**C**

## Is Everything Correct?

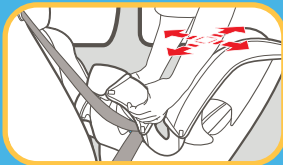
**3**

**Car Seat Does Not Move More than 1" (2.5 cm) at the Belt Path**

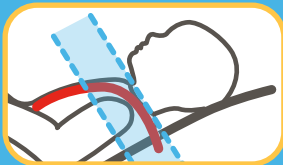

**Harness Straps at or Just Below the Child's Shoulders**

Review section 5

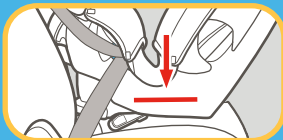

**Level Line is Level with the Ground**

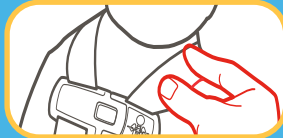

**Cannot Pinch Harness Straps at the Shoulder**

Review section 5

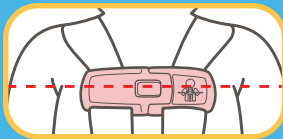

**Chest Clip Even With Armpits**

Review section 5

# 4 4-A | Forward-Facing Use

C

**Forward-Facing:**  
**22-65 lb (10-30 kg)**  
**49 inches (125 cm) or less**



- Place car seat forward-facing in the vehicle back seat.
- Make sure lower anchor strap or vehicle seat belt is routed through the forward-facing belt path marked with an orange label.
- Install this car seat tightly in your vehicle. Car seat **should not move** at the forward-facing belt path more than 1" (2.5 cm) from side to side, front to back.

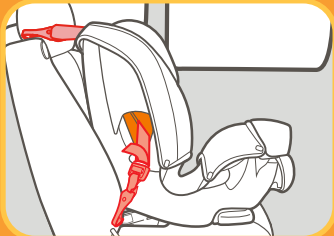

## LATCH

**Do not install by this method for a child weighing more than 55 lb (25 kg)**

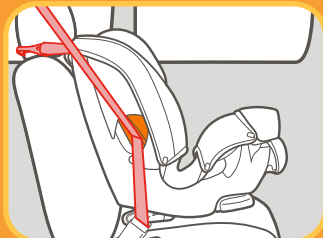

**Vehicle Lap/Shoulder Seat Belt with Tether**

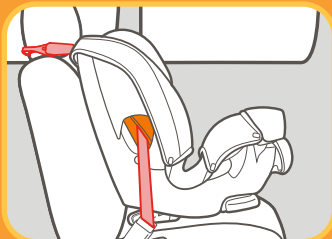

**Vehicle Seat Lap Belt With Tether**

- Harness straps need to be **at or just above** the top of child's shoulders and chest clip at **armpit level**.
- Children are safer riding rear-facing and should ride rear-facing as long as possible, until they reach the maximum rear-facing height or weight rating for their car seat. Then children should ride forward-facing, using the built-in harness system for as long as possible until they reach the maximum forward-facing weight or height for their car seat. At that point, children should ride in a belt-positioning booster seat. Be sure to check your local and state laws, as well as AAP and NHTSA recommendations, for car seat usage.

# 4 4-B | Install Forward-Facing With LATCH

C

*Review your vehicle's owner manual for LATCH location and use. Do not install by this method for a child weighing more than 55 lb (25 kg)*

- 1. Remove Lower Anchor Connectors from Storage Location**
- 2. Make Sure Lower Anchor Strap is in the Forward-Facing Belt Path Marked with Orange Label**

If not, see section 7 to move lower anchor attachment.

- 3. Rotate The Flip Foot**

Rotate the flip foot on the bottom of the car seat into the forward-facing position marked with an orange label. The orange arrow must be pointing up. The flip foot is secure when it “clicks” into place.

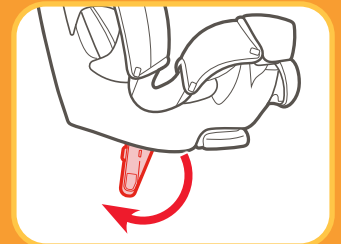
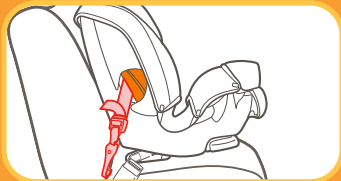
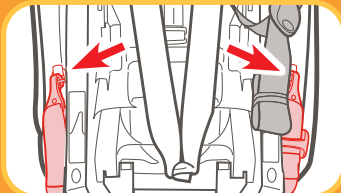
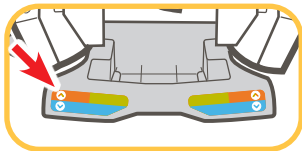

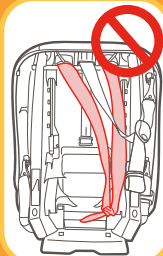
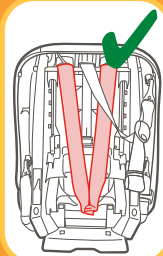

#### 4. **Check the Harness Position**

Check the harness position in the back of seat. It should be positioned in the center of the seat, and not shifted to one side.

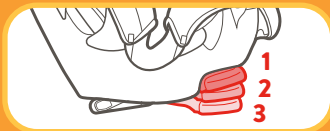
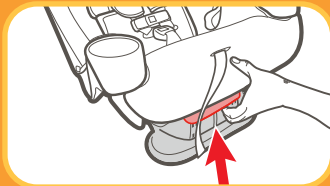

#### 5. **Recline the Car Seat**

Squeeze the lever on front of car seat and place the car seat in one of the three recline positions.

**For children under 40 lb (18 kg) you MUST use recline positions 2 or 3.**

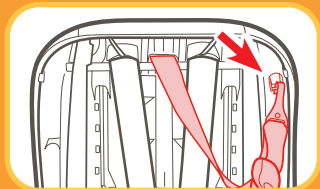

#### 6. **Unhook Tether Hook From Storage**

Unhook tether and lay it in the seat.

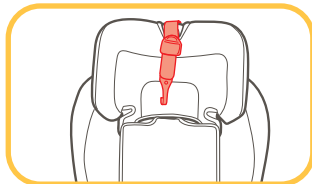

### **7. Place Car Seat Forward-Facing in Back Seat of the Vehicle**

Place forward-facing in vehicle seat and center the car seat between the lower anchors. The bottom of the seat and flip foot should sit as flat as possible on the vehicle seat.

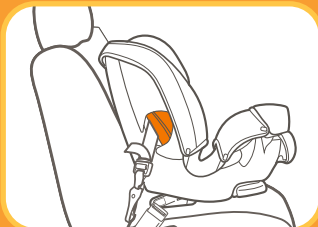

### **8. Make Sure Base is a minimum of 80% on Vehicle Seat.**

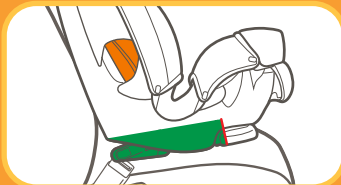

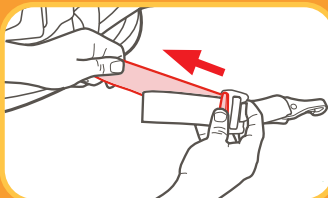

### 9. **Extend the Lower Anchor Strap**

For easier installation, extend the lower anchor strap to its maximum length by pressing the grey button and pulling on the strap.

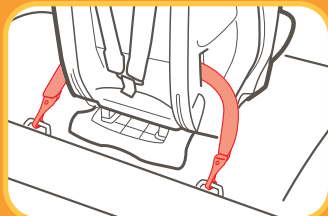

### 10. **Connect Lower Anchor Connectors to the Vehicle's Lower Anchors**

Lower anchor strap should lay as flat as possible and not be twisted.

If the strap is twisted, you will not be able to tighten the strap. Do not attach the hook upside down.

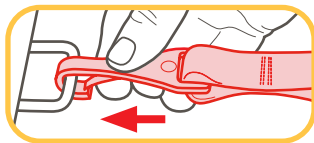
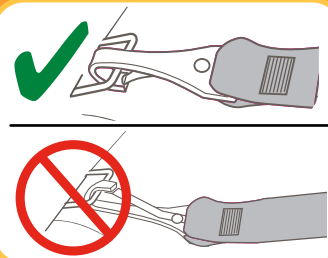

### 11. Tighten the Lower Anchor Strap

Press down firmly in the center of the car seat while tightening the lower anchor strap to remove all the slack.

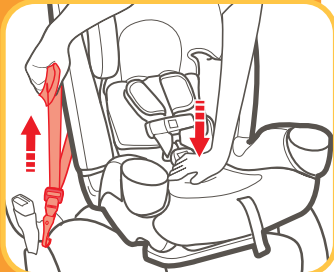

### 12. Attach Tether Hook

Extend the tether by lifting up on the tether lock and attach.

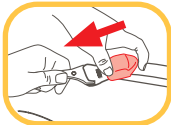

Consult vehicle's owner manual for specific location.

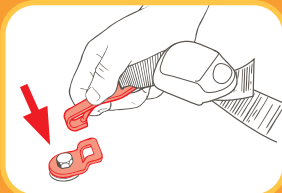



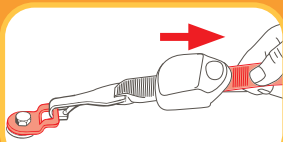

### 13. Tighten Tether Strap

Remove all the slack.

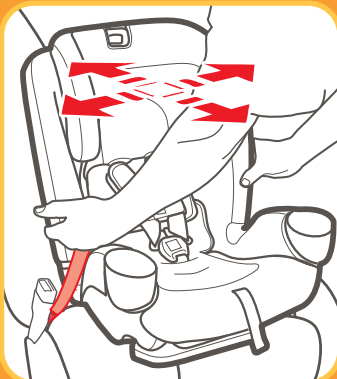

### 14. Test For Tightness

Grab the sides of the seat where the lower anchor strap is and slide the car seat side-to-side and front-to-back.

If the seat moves less than 1" (2.5 cm), it is tight enough.

**See section 5-A to secure your child.**

# 4 Is Everything Correct?



**Car Seat Does Not Move More than 1" (2.5 cm) at the Belt Path**



**Harness Straps at or Just Above the Child's Shoulders**

Review section 5

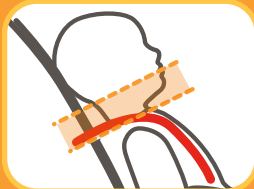

**Chest Clip Even With Armpits**

Review section 5

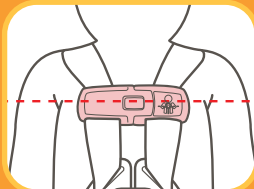

**Cannot Pinch Harness Straps at the Shoulder**

Review section 5

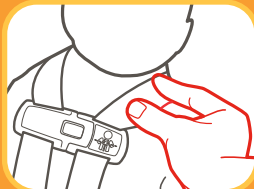

**C**

## 4-C | Install Forward-Facing with Vehicle Seat Belt

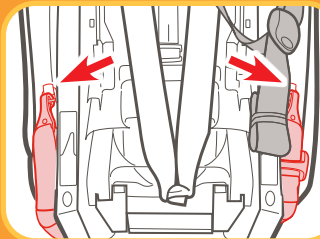
**4**

### 1. Store Lower Anchor Connectors

Attach lower anchor connectors to the plastic bars as shown.

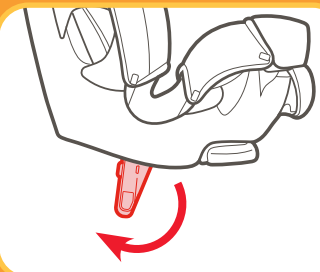

### 2. Rotate The Flip Foot

Rotate the flip foot on the bottom of the car seat into the forward-facing position marked with an orange label. The orange arrow must be pointing up. The flip foot is secure when it “clicks” into place.

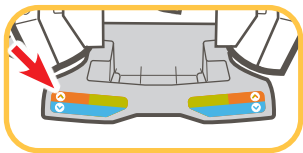

### 3. Check the Harness Position

Check the harness position in the back of seat. It should be positioned in the center of the seat, and not shifted to one side.

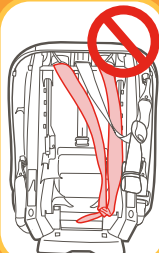
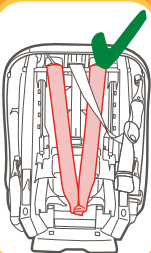

#### 4. Recline the Car Seat

Squeeze the lever on front of car seat and place the car seat in one of the three recline positions.

For children under 40 lb (18 kg) you **MUST** use recline positions 2 or 3.

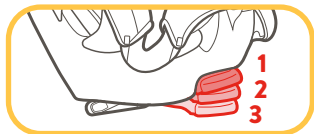

#### 5. Unhook Tether Hook From Storage

Unhook tether and lay it in the seat.

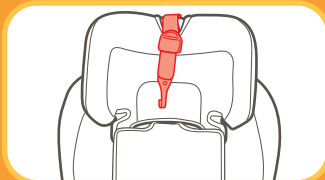
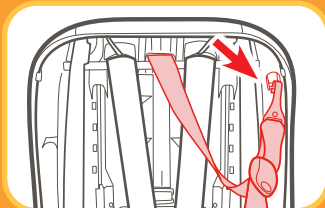
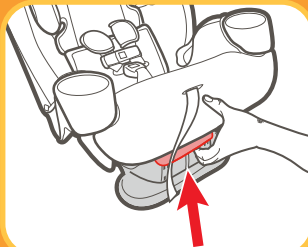

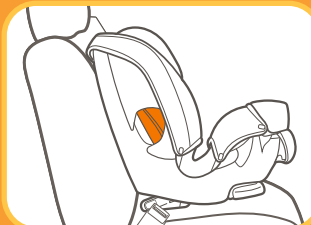

**6. Place Car Seat Forward-Facing in Back Seat of the Vehicle**

Place forward-facing in vehicle seat. The bottom of the seat and flip foot should sit as flat as possible on the vehicle seat.

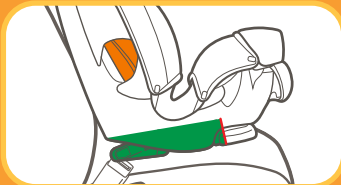

**7. Make Sure Base is a minimum of 80% on Vehicle Seat.**



**Review your vehicle's owner manual for vehicle seat belt use**

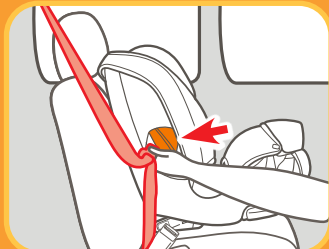

**8. Route the Vehicle Seat Belt**

Thread vehicle seat belt through the forward-facing belt path (marked with an orange label) and out the other side. Buckle the seat belt. The seat belt should lie as flat as possible and not be twisted.

### **9. Lock the Vehicle Seat Belt**

In most vehicles today, slowly pull the shoulder belt all the way out and then let it go back in. You will hear a clicking sound. Slowly pull out on the belt and it should be locked. If not, review your car's owner manual and section 9-D.

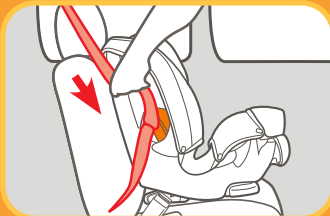

### **10. Tighten the Vehicle Seat Belt**

Press down firmly in the center of the car seat. Pull on the shoulder belt to tighten while feeding the slack back in the retractor.

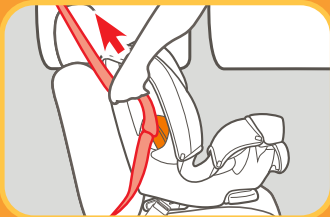

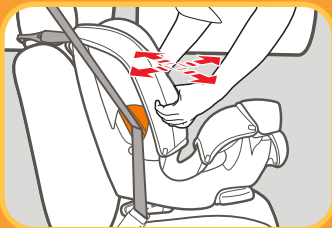
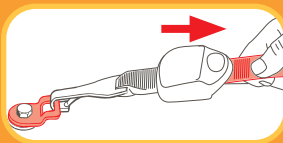
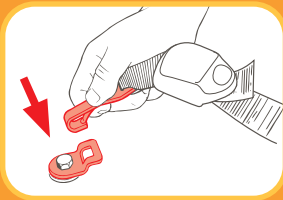

### **11. Attach Tether Hook**

Extend the tether by lifting up on the tether lock and attach. Consult vehicle's owner manual for specific location.

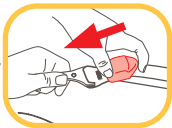

### **12. Tighten the Tether Strap**

Push the car seat back while tightening the tether strap to remove all the slack.

### **13. Test For Tightness**

Grab the sides of the seat where the vehicle seat belt is and slide the car seat side-to-side and front-to-back.

If the seat moves less than 1" (2.5 cm), it is tight enough.

**See section 5-A to secure your child.**

# 4 Is Everything Correct?



**Car Seat Does Not Move More than 1" (2.5 cm) at the Belt Path**

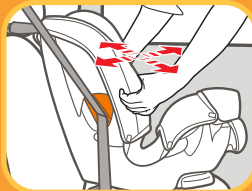

**Harness Straps at or Just Above the Child's Shoulders**

Review section 5

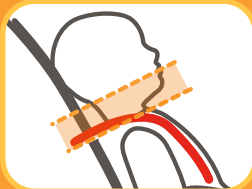

**Chest Clip Even With Armpits**

Review section 5

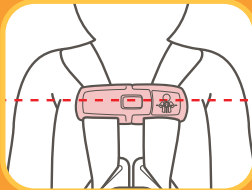

**Cannot Pinch Harness Straps at the Shoulder**

Review section 5

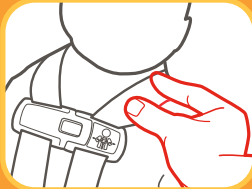



**! WARNING!**

**WARNING!** In cold weather, do not put snowsuits or bulky garments on your child when placing them in the car seat. Bulky clothing can prevent the harness straps from being tightened properly. To keep child warm, buckle your child in the car seat and place a blanket around the child or place the child's coat on backwards after buckling in.

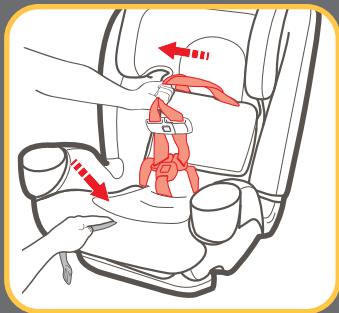
**1. Loosen Harness Straps**

Push down on the harness adjustment lever while pulling out on the harness straps at the chest clip.

## 2. Release the Chest Clip

Press the chest clip release button and pull apart.

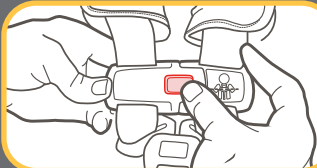

## 3. Unbuckle the Buckle

Press the red button and pull buckle tongues out. Place harness straps off to the sides.



## 4. Place Your Child in the Seat

Make sure their back is flat against the car seat back.



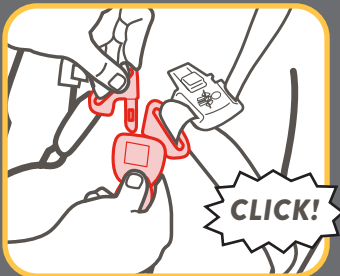

### 5. Place Harness Straps Over Child's Shoulders and Buckle

You will hear a “CLICK” when buckle tongues are securely attached. Pull up on each buckle tongue to make sure it is securely attached.



**REAR-FACING**



**FORWARD-FACING**

### 6. Be Sure the Harness Straps Are at the Proper Height

**Rear-Facing:** Harness straps should be **at or just below** the child's shoulders. Top of head **must be at least 1" (2.5 cm) below** the headrest adjustment lever.

**Forward-Facing:** Harness straps should be **at or just above** the child's shoulders. Top of child's ears **below** top of headrest.

### **7. To Raise or Lower Headrest/Harness Height**

Pull up on the adjustment handle and move headrest for the proper harness height.

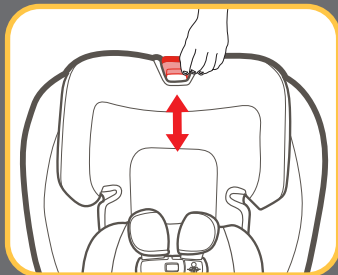

### **8. Check the Buckle Position**

The correct slot is the one that is closest to your child without being underneath them.

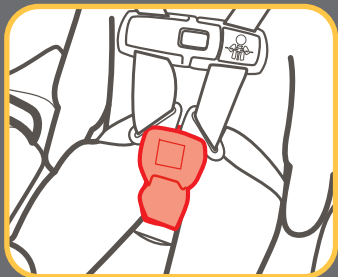

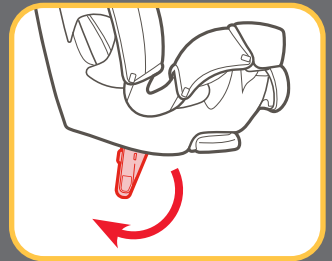
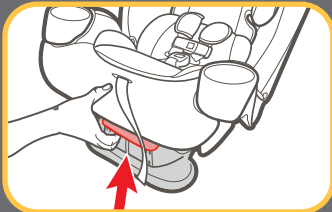

## 9. To Change Buckle Position

Remove child from the seat. Recline the car seat fully and rotate the flip foot on the bottom of the car seat into the forward-facing position with the orange arrow pointing up to locate the metal retainer under the car seat shell.

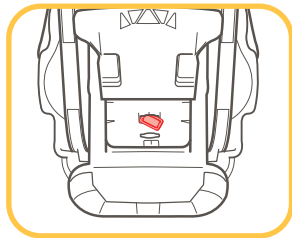



From the bottom of car seat, insert the buckle's metal clip up through shell and pad.

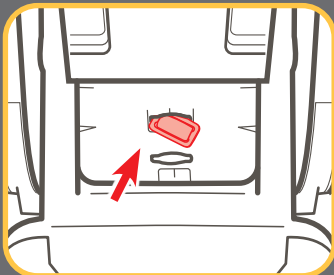

From the front, pull buckle out of the pad and shell.

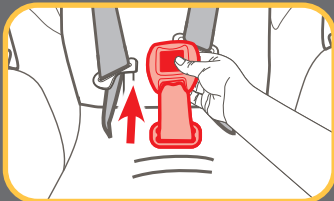

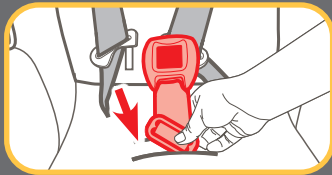
**C****5*****Insert Metal Clip Into New Location***

Push metal clip down through the pad and shell. Make sure the buckle's red button is facing out.

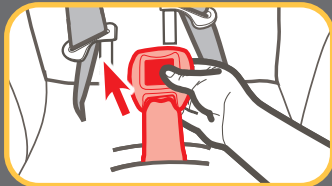
***Pull Up On Buckle To Check It Is Secured***

Make sure buckle's metal clip is completely through pad and shell.

### ***Rear-Facing With Lower Anchor Attachment***

Make sure the lower anchor strap is **(A)** in front of the buckle strap when the buckle is in the inner-most position, and **(B)** behind when in the outermost position and that it is flat and is not twisted.

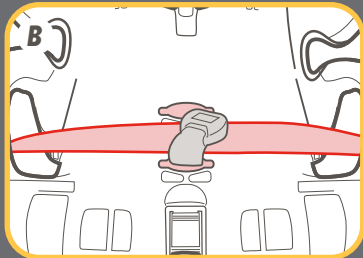
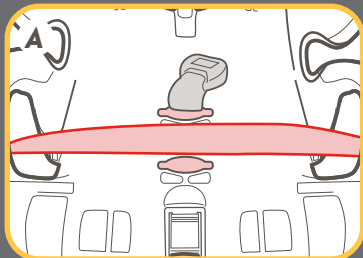

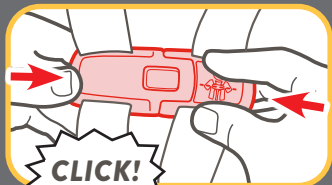

**C****C****C****C****5**

### **10. Buckle the Chest Clip**

You will hear a “click” when the chest clip is securely buckled attached.

### **11. Pull All the Slack Out From Around the Waist**

Pull up on the harness strap while pushing the chest clip down. Do this to both sides.

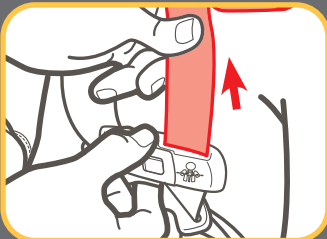

### **12. Tighten the Harness by Pulling the Harness Adjustment Strap**

When you are not able to pinch any of the harness webbing at your child's shoulder, the harness is tight enough.

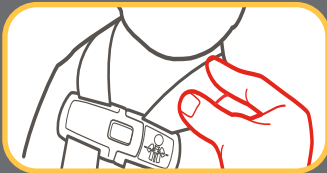
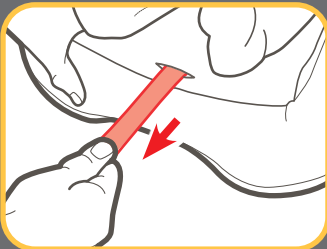

A snug harness should not allow any slack. It lies in a relatively straight line without sagging. It does not press on the child's flesh or push the child's body into an unnatural position.

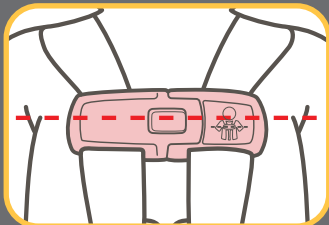

**13. Raise the Chest Clip to Child's Armpit Level**

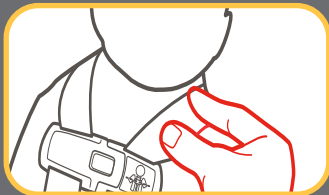

**14. Check Tightness**

Tighten more if needed.

### 1. Loosen Harness Straps

Push down on the harness release lever under the seat pad while pulling out on the harness straps at the chest clip.

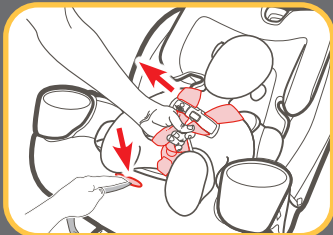

### 2. Release the Chest Clip

Press the chest clip release button and pull apart.

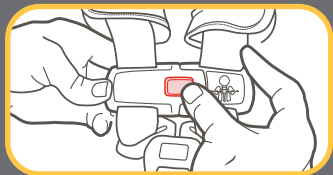

### 3. Unbuckle Your Child

Press in on the red button and remove the buckle tongues. Remove Child from the seat.

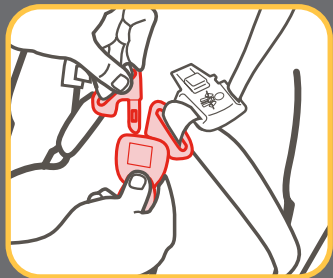

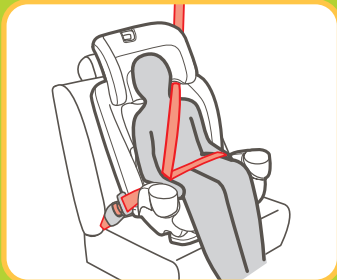

**Vehicle Lap/Shoulder Seat Belt**



**Never Use a Vehicle Lap-Only Belt Across Front of Child**

**Highback  
Booster:**  
**40-100 lb  
(18.1-45 kg)  
43-57" (110.1-  
145 cm) at least 4 years old**



- Place car seat forward-facing in the vehicle back seat.
- Make sure vehicle seat's lap belt is adjusted snugly and lays low on the child's hip and is routed behind the armrest in the booster's belt path.
- Vehicle belts **MUST** lie flat against child and **MUST NOT** be twisted.
- Vehicle seat's shoulder belt is adjusted snugly and should lie between child's neck and edge of shoulder.
- **Never** use a vehicle lap-only belt across front of child.
- **DO NOT** position vehicle shoulder belt under the child's arm or back.
- **DO NOT** allow child to slouch or slide down in the booster seat.

- **DO NOT** position vehicle belt over top of armrests.
- Vehicle's seat headrest **SHOULD NOT** create a gap between vehicle seat and booster seat.
- The front of booster seat **MUST NOT** hang over front of vehicle seat.
- If child will not keep vehicle belt properly positioned, **DO NOT** use this booster seat. Use a different car seat.
- When forward-facing, children should use the built in harness system for as long as possible until they reach the maximum forward-facing weight or height for their car seat. At that point, children should ride in a belt-positioning booster seat. A booster is no longer needed once the vehicle seat belt fits properly, typically when they reach 4 feet 9 inches (145 cm) tall and are between ages 8-12. Be sure to check your local and state laws, as well as AAP and NHTSA recommendations, for car seat usage.

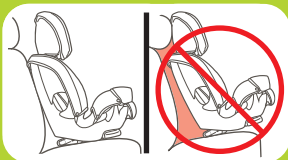

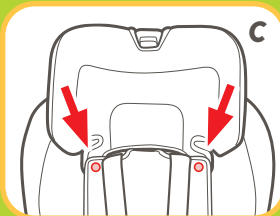
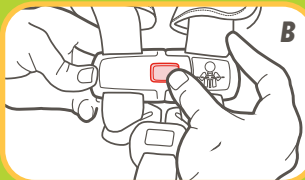
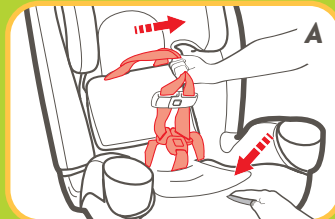
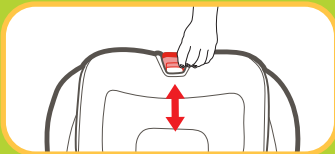
**C****6-B | Install Highback Booster****6****1. Raise The Headrest To The Highest Position**

Pull up on the adjustment handle and lift headrest to the highest position.

**2. Store The Harness System****A. Loosen The Shoulder Straps**

Push down on the harness adjustment lever while pulling out on the harness straps at the chest clip.

**B. Unbuckle the chest clip****C. Unsnap Pad and Expose Seat Back**

Undo the 2 snaps in the headrest pad.

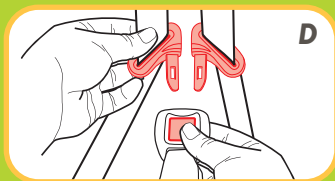
**D. Unbuckle the buckle****E. Remove Harness Covers and Store for Future Use**

To remove, undo the fastening strips and remove.

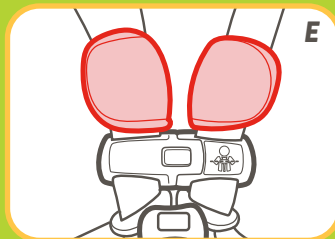
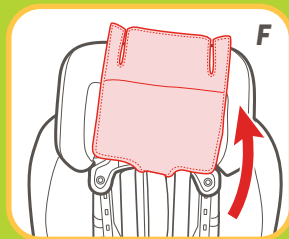
**F. Lift the headrest pad flap up out of the way**

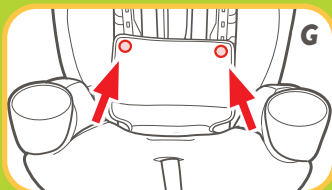

**G. Unsnap Seat Pad**

Undo the 2 snaps.

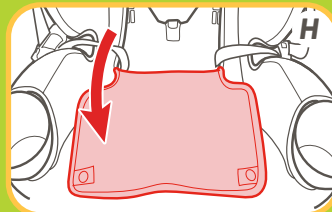
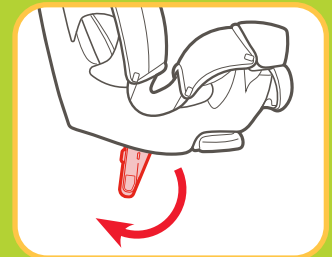
**H. Pull Bottom Seat Pad Forward To Expose the Plastic Shell****I. To Remove the Buckle Strap:**

Rotate the flip foot on the bottom of the car seat into the forward-facing position. The orange arrow must be pointing up.

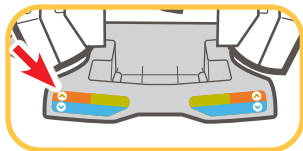

Recline the car seat fully and locate the metal retainer under the car seat shell.

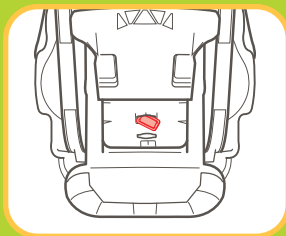
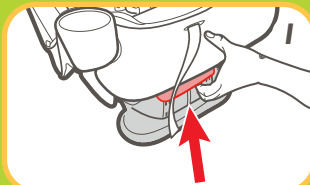

From the bottom of car seat, insert the buckle's metal clip up through shell and pad.

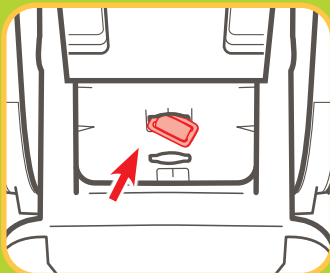

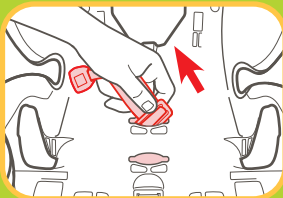

From the front, pull buckle out of the pad and shell.

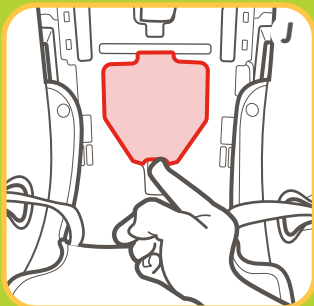

**J. Open the Harness Storage Door**

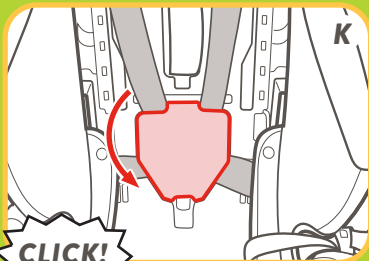

**K. Place Harness, Chest Clip, Buckle Tongues and Buckle Inside Storage Compartment and Close the Door**

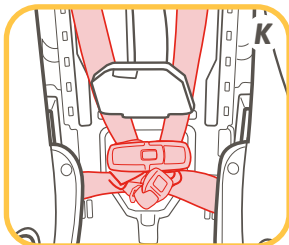

### **L. Replace Seat Pad**

Move the headrest back to its proper position for your child.

### **3. Recline the Car Seat**

Squeeze the lever on front of car seat and place the car seat in the most upright position.

**Booster mode MUST use recline position 1**



### **4. Check the flip foot**

Confirm that the flip foot is in the forward-facing position. The orange arrow must be pointing up.

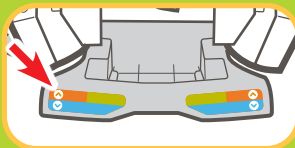
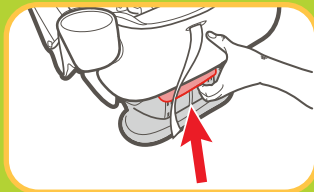

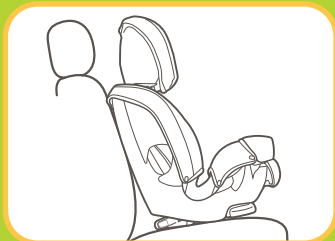
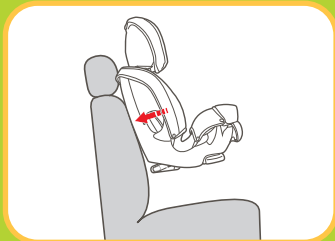

### 5. Place Car Seat Forward-Facing in Back Seat of the Vehicle

Touch the back of the booster seat firmly against the vehicle seat back. Make sure the booster seat back is flat against the vehicle seat back.

Slide the booster seat down along the vehicle seat back until the bottom of the booster seat and flip foot rests on the vehicle seat.

Make sure the base **completely** rests on the vehicle seat. The front of booster seat **MUST NOT** hang over front of vehicle seat.



**Skip to Step 14 on page 87 if Not Using LATCH**

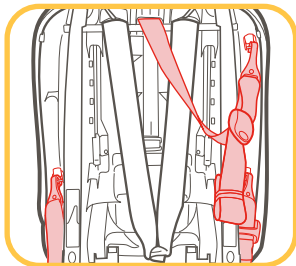

Century allows the securing of the car seat with LATCH system in the booster mode only if the vehicle manufacturer allows it. The child still **MUST BE SECURED** with the vehicle lap/shoulder seat belt. LATCH can be used in the booster mode regardless of the weight of the child up to 100 lb (45 kg). If securing the car seat with the lower anchor connectors in booster mode, the

tether **MUST** be used.

Verify the following before using LATCH in the booster mode:

- The lower anchor connectors **DO NOT** interfere with any vehicle seat belts or buckles.

If the lower anchor connectors interfere with the vehicle seat belts or if the chosen seating position does not have lower anchors, you **MUST** store the lower anchor connectors. Store the lower anchor connectors by attaching to the plastic bars as shown. Store the tether as shown. Always secure car seat with lower anchor attachment or a vehicle seat belt, even when unoccupied. In a crash, an unsecured car seat can injure passengers.

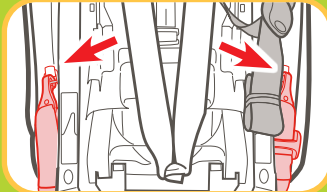

**6. Remove Lower Anchor Connectors from Storage Location**

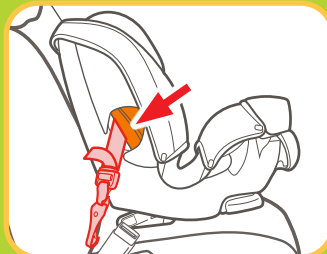

**7. Make Sure Lower Anchor Strap is in the Forward-Facing Belt Path Marked with Orange Label**

If not, see section 7 to move lower anchor attachment.

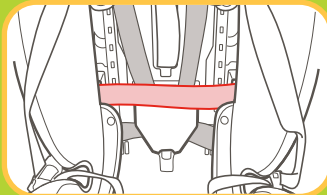

Make sure the lower anchor attachment is routed in front of the harness straps, is flat, and is not twisted.

### 8. Unhook Tether From Storage Location and Lay it in the Seat

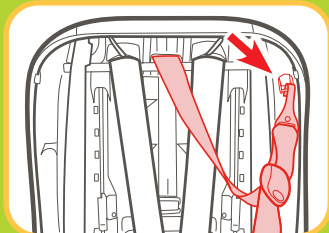
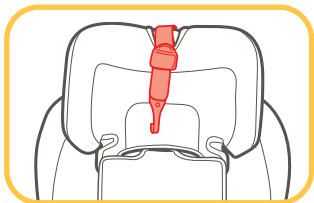

### 9. Extend the Lower Anchor Strap

For easier installation, extend the lower anchor strap to its maximum length by pressing the grey button and pulling on the strap.

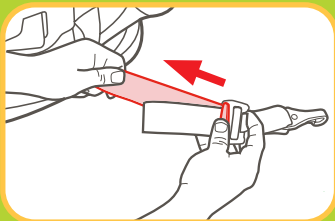



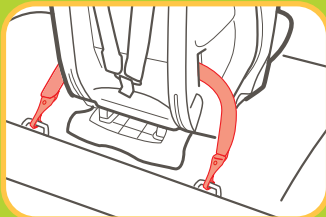

### 10. Connect Lower Anchor Connectors to the Vehicle's Lower Anchors

Lower anchor strap should lay as flat as possible and not be twisted. If the strap is twisted, you will not be able to tighten the strap. Do not attach the hook upside down.

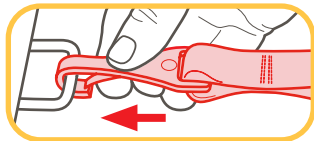
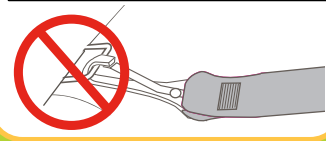

### 11. Remove All The Slack From The Lower Anchor Strap

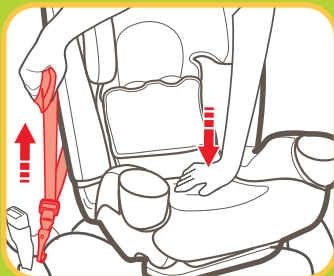

### 12. Attach Tether Hook

Extend the tether by lifting up on the tether lock and attach.

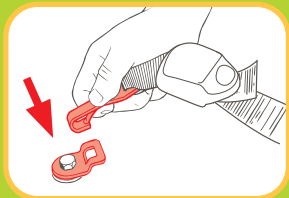
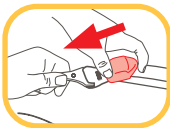

Consult vehicle's owner manual for specific location.

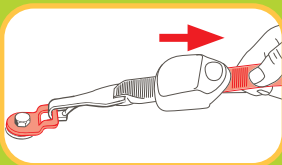

### **13. Tighten Tether Strap**

Remove all the slack.

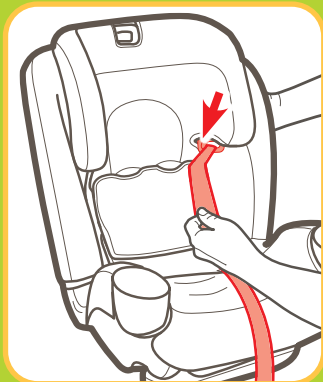

### **14. Thread the Vehicle Seat Shoulder Belt Through Seat Belt Guide on the Headrest**

See section 6-C to secure your child.

## 6 6-C | Securing Child Highback Booster

C

### **⚠ WARNING!**

Use only the vehicle lap and shoulder belt system when restraining the child in the booster seat.

#### **1. Place Child In Seat**

Have your child sit in the booster seat, with his/her back flat against the back of the booster seat.

#### **2. Thread Vehicle's Shoulder Belt Into Seat Belt Guide in the Headrest**

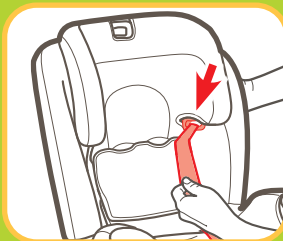

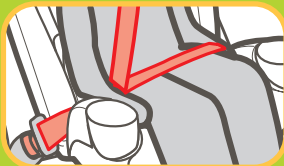

### **3. Buckle the Vehicle Lap/Shoulder Seat Belt**

Be sure the lap portion of the vehicle seat belt goes behind the armrests.

Be sure the lap portion of the vehicle seat belt lies low across your child's hips.

Be sure the shoulder belt lies across your child's shoulder, between the neck and edge of shoulder. The belt guides should be even with or just above the shoulders.

# 6 Is Everything Correct?



***Never Use Lap Belt Only***



***Lap Belt Behind Armrest  
and Lies Low Across Hips  
and Thighs***



***Shoulder Belt Lies On  
the Shoulder, Between  
the Neck and Edge of  
Shoulder***

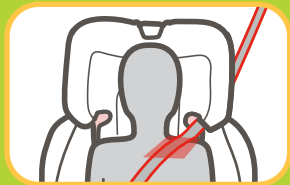

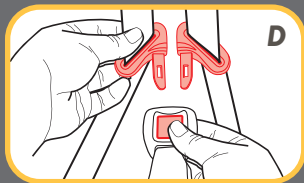
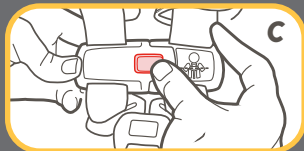
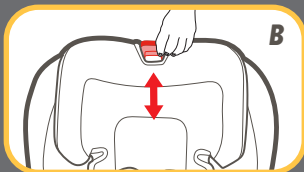

### **1. For Ease of Moving the Lower Anchor Attachment**

- A.** Loosen the harness straps.
- B.** Raise the headrest to the highest position.
- C.** Unbuckle the chest clip.
- D.** Unbuckle the buckle.

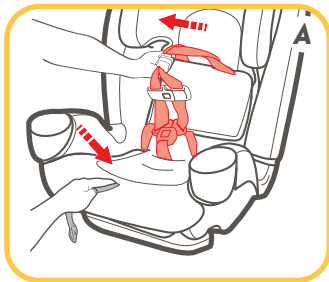



- E. Lift the headrest pad flap up out of the way.**

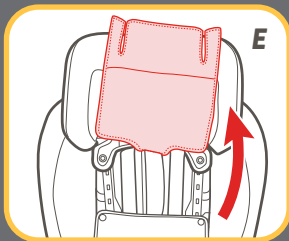

- F. Unsnap Seat Pad**

Undo the 2 snaps.

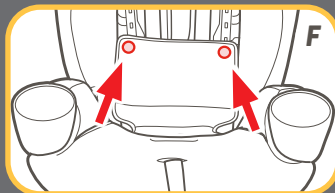

- G. Pull Bottom Seat Pad Forward To Expose the Plastic Shell**

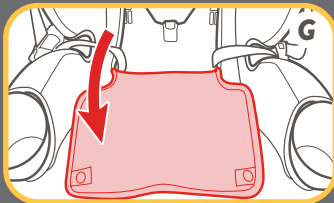



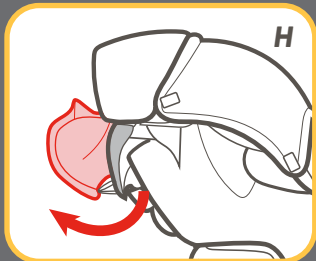

**H.** On the child's left-hand side, undo the fabric below the cup holder.

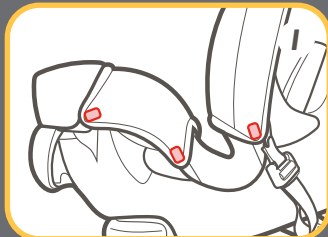

**I.** On the child's left-hand side, undo the 3 seat pad hooks.

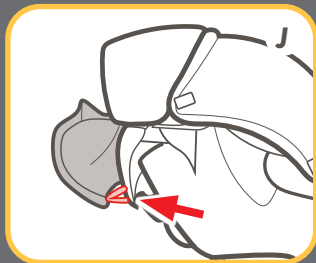

**J.** On the child's left-hand side, undo the loops on the front of the seat below the cup holder.

## 2. Pull the Lower Anchor Connectors Out of the Belt Path Openings

Move the seat pad on the child's left-hand side out of the way.

Then pull the lower anchor connectors out of the belt path openings, so that the lower anchor connectors lay in the seat.

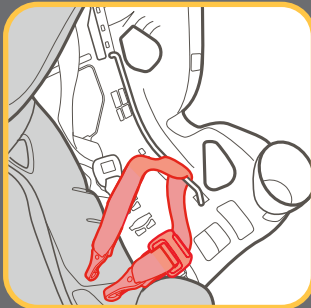

## 3. Slide Entire Lower Anchor Strap Along Bar to the Desired Belt Path Opening

**Rear-Facing:** Slide lower anchor strap along bar to the front of the seat.

**Forward-Facing:** Slide the lower anchor strap up along bar to the top.

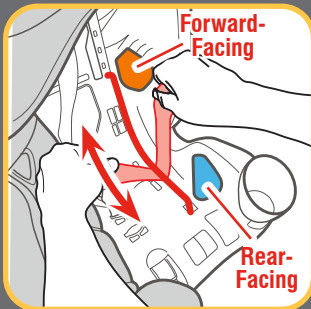

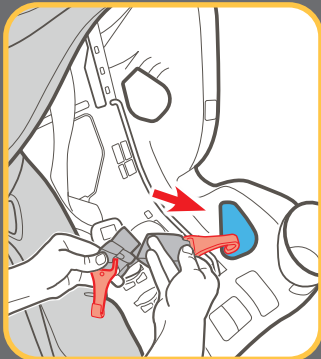

**4. Push the Lower Anchor Hooks Out Through the Desired Belt Path Openings on Each Side of Car Seat**

**Rear-Facing:** Make sure the Lower Anchor strap is in front of the buckle strap when the buckle is in the inner-most position **(A)**, and behind when in the outer-most position **(B)** and that it is flat and is not twisted.

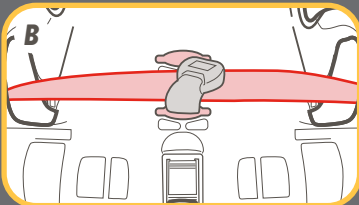
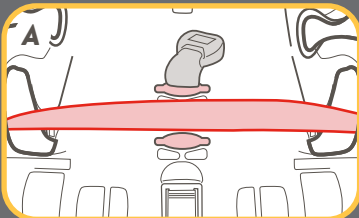



**Forward-Facing:** Make sure the lower anchor attachment is routed behind the harness strap, is flat, and is not twisted.

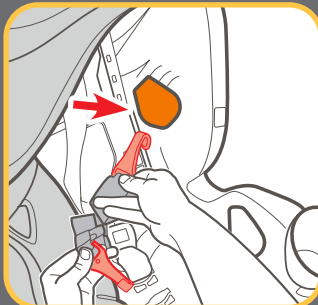
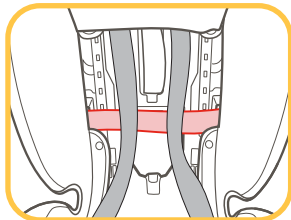

## 5. Replace the Seat Pad

Move the headrest back to its proper position for your child.



**⚠ WARNING!**

To prevent ejection in sudden stop or crash: The body support can **ONLY** be used in Rear-Facing mode.

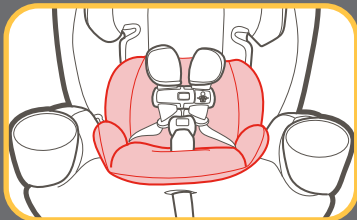
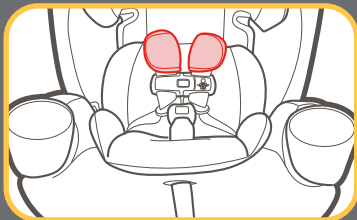
***Harness Covers***

Make sure that harness covers do not interfere with placement of the chest clip at armpit level. To remove, undo the fastening strips and remove.

***Infant Body Support***

**Use only in the rear-facing mode.**

Body support must be used if shoulders are below the lowest harness height setting.

Never allow infant body support to bunch or fold behind child.

**Lower Anchor Connectors:**

- 1. Push Gray Button In While Pulling on Lower Anchor Attachment Strap to Loosen**
- 2. Press and Hold Lower Anchor Connector Release Hinge**
- 3. Push Hook In, Lift Hook Up and Pull Out Away From Anchor Point**

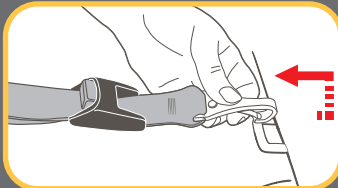
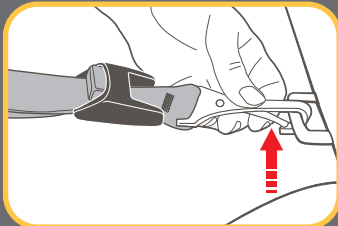
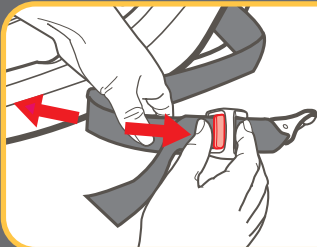

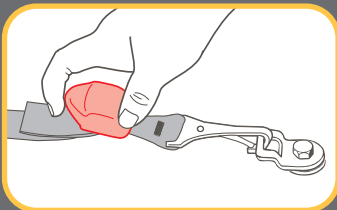

**Tether:**

**1. To remove, lift up on the tether lock to release the tension.**

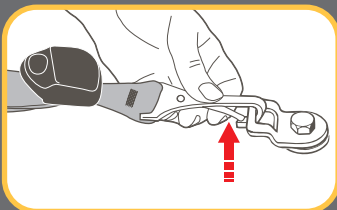

**2. Press and Hold Tether Release Hinge**

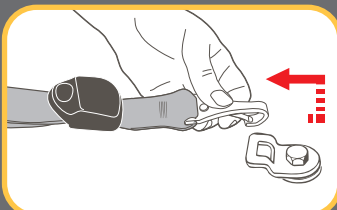

**3. Push Hook In, Lift Hook Up and Pull Out Away From Anchor Point**

***Review your vehicle owner's manual for seating locations.***

***The best seating location for this car seat is one that:***

- Is recommended by your vehicle owner's manual, and
- Results in a secure installation of this car seat

In the event there is no available back seat and / or you have no other option than to place a child in a front passenger seating position (other than rear-facing), the National Highway Traffic Safety Administration (NHTSA) recommends that you take the following steps:

- Ensure the child is properly restrained according to their age and size
- Move the seat as far back as possible
- Make sure the child is not leaning out of position, such as leaning forward into the deployment path of the air bag
- Set the air bag ON-OFF switch, if available, to the OFF position



Never install this car seat in any of the following vehicle seating locations:



rear-facing or side-facing vehicle seats



rear-facing with an active front air bag



booster mode with vehicle lap belt only seat belt

## 9-D | Vehicle Seat Belts

***Review your vehicle owner's manual for vehicle seat belt use***

This car seat can be installed using a vehicle seat belt. To do this, you will need to change the seat belt to a locked mode for use with car seats. With some vehicle seat belts, this is done with the latch plate; with other vehicle seat belts, this is done with the retractor.

## Vehicle Seat Belt Terms

### Retractor

A device that winds up the unused vehicle seat belt. It is often hidden inside the panels on the walls of the vehicle or in the vehicle seat back.

### Latch Plate

The male end of the seat belt with the silver tongue.

### Seat Crease

The crease where the vehicle seat back and seat bottom meet.

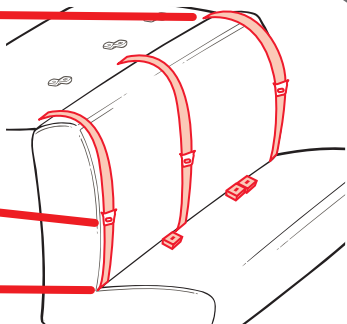

## Identify Your Seat Belt Type

There are two different types of vehicle seat belts that can be used with this car seat:

### Lap/Shoulder Seat Belt

3 connection points.

Can be used in all car seats modes of use.

### Lap Only Seat Belt

2 connection points.

Can **ONLY** be used in harness mode.

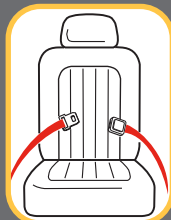

The following types of vehicle seat belts **CANNOT** be used safely with this car seat:



Lap Belt with Motorized Shoulder Belt



Lap Belt or Shoulder Belt Mounted on Door

Belts Forward of the Seat Crease

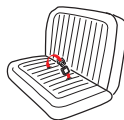

Some vehicles you may not get a secure fit. Read both your vehicle and car seat manuals.

## Lap/Shoulder Seat Belt Installation - Rear-Facing/ Forward-Facing Modes

**Always review your vehicle owner's manual for specific information about your vehicle seat belts.**

There are three types of retractors: **ELR (Emergency Locking Retractor)**, **ALR (Automatic Locking Retractor)**, and **Switchable (ELR switch to ALR)**. To determine your type of retractor, follow these steps:

1. **Slowly** pull the belt out about halfway and stop.
2. Let the belt retract back several inches.
3. Try to **slowly** pull the belt out more.

If the belt cannot be pulled any further, it is **ALR**, ready to install your car seat. If it can be pulled further, go to the next step.

4. **Slowly** pull the belt **all the way out**, and then allow it to retract several inches. You may hear some clicking sounds.

5. Try to pull the belt all the way out again.

If it cannot be pulled out, it is **Switchable**, ready to install your car seat. If it can still be pulled out freely, it is **ELR**. Review the following pages to properly install your car seat.

**Note:** Most vehicles manufactured after 1996 will have Switchable retractors in the back seat. If you have any questions about your retractor type, consult your vehicle owner's manual or call Century for assistance at:

1-844-385-0249

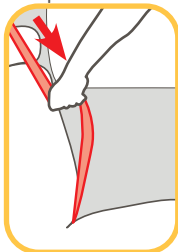

## How to Lock Your Lap/Shoulder Vehicle Seat Belt

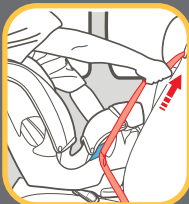
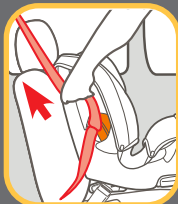
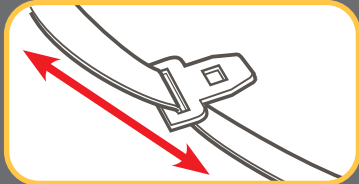

**Note:** With the vehicle seat belt in this locking mode, all the tension is upwards in the shoulder belt. This may start to tilt your car seat sideways when rear-facing. If this happens, use a locking clip instead of switching the retractor. See Sliding Latch Plate and ELR Retractor.

### Sliding Latch Plate and Switchable Retractor

A latch plate that slides freely on the belt webbing and cannot, by itself, hold the belt snug around a car seat.

When installing the car seat, route the vehicle seat belt through the proper belt path and buckle it in.

**Slowly pull the shoulder belt all the way out to switch it to locking mode.**

Then, as you pull the vehicle seat belt tight, feed all the slack back into the retractor.

Grab the sides of the seat at the belt path and slide side to side and front to back. The seat should not move more than 1" (2.5 cm).

### **Locking Latch Plate and ELR Retractor**

A latch plate that holds the lap belt snug after it has been adjusted; contains a metal bar on the underside of the hardware that “locks” the belt in position. When installing the car seat, route the vehicle seat belt through the proper belt path and buckle it in. Then, pull upwards on the shoulder belt so that the lap belt gets tight around the car seat.

Grab the sides of the seat at the belt path and slide side to side and front to back. The seat should not move more than 1” (2.5 cm).

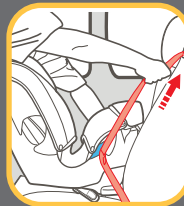
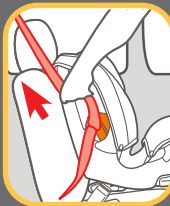
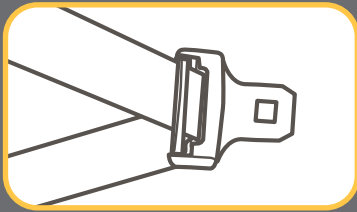

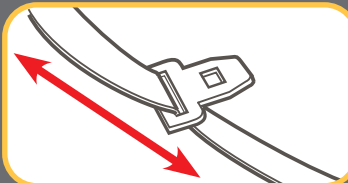

### **Sliding Latch Plate and ALR Retractor**

A latch plate that slides freely on the belt webbing and cannot, by itself, hold the belt snug around a car seat.

**Slowly pull the shoulder belt all the way out.** Route the vehicle seat belt through the proper belt path and buckle it in. Then, as you pull the vehicle seat belt tight, feed all the slack back into the retractor.

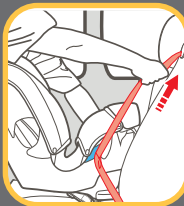

Grab the sides of the seat at the belt path and slide side-to-side and front-to-back. The seat should not move more than 1" (2.5 cm).

### **Sliding Latch Plate and ELR Retractor**

A latch plate that slides freely on the belt webbing and cannot, by itself, hold the belt snug around a car seat.

With this retractor, you will need to use the locking clip to lock the vehicle seat belt.

To obtain a locking clip call 1-844-385-0249 .

Route the vehicle seat belt through the proper belt path and buckle it in. Pull the vehicle seat belt tight. While pushing down on seat, pinch the two straps together behind the buckle tongue. Unbuckle the belt without allowing it to slip. Attach locking clip to lap and shoulder belts as shown.

Buckle belt. Check that lap belt does not move by pulling hard. If belt loosens or lengthens, repeat procedure.

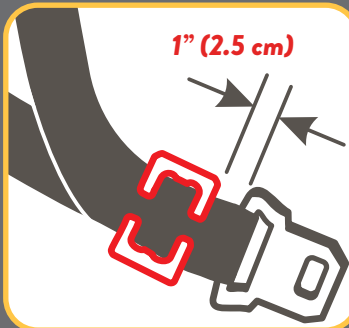
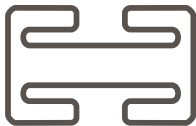
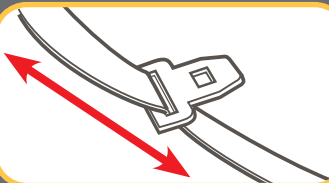



## Lap Belt Installation - DO NOT use in Booster Mode

*Always review your vehicle owner's manual for specific information about your vehicle seat belts.*

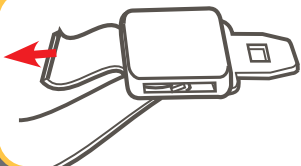

Grab the sides of the seat at the belt path and slide side to side and front to back. The seat should not move more than 1" (2.5 cm).



### **Locking Latch Plate and No Retractor**

When installing the car seat, route the lap seat belt through the proper path and buckle it in. Then, pull upwards on the tail of the belt so that the lap belt gets tight around the car seat.

### **Sewn On Latch Plate and ALR Retractor**

**Slowly pull the lap belt all the way out.** Route the vehicle seat lap belt through the proper belt path and buckle it in. Then, pull the lap belt tight while feeding all the slack back into the retractor.

**Refer to seat pad care tag for washing instructions.**

### **Head Support Cover**

Clean with a damp sponge using mild soap and cool water. If needed, pad may be removed for cleaning.

To remove head support cover raise the headrest to the highest position.

Unsnap the 2 outer headrest pad snaps.

Lift the headrest pad flap up out of the way.

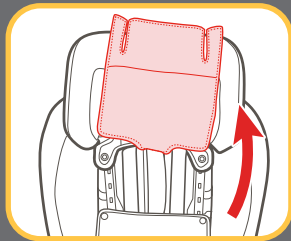
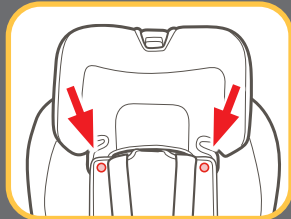
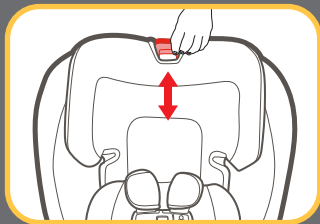

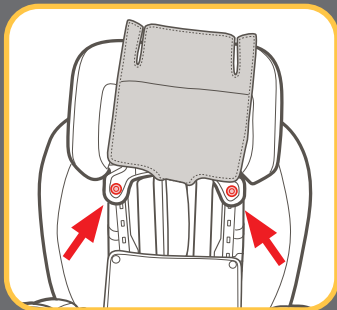

Undo the two snaps below the head support.

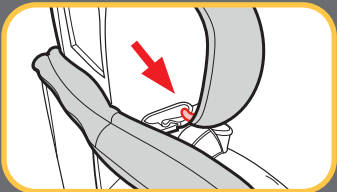

Undo elastic loops inside each shoulder belt guide.

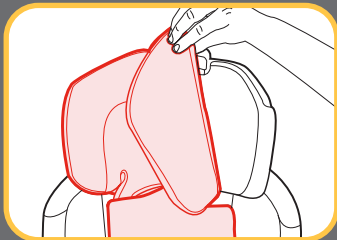

Peel cover off head support.

Unhook plastic tab below the Headrest Height Adjustment Lever.

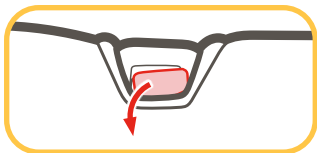

Machine wash pad in cold water on delicate cycle and drip-dry. **DO NOT USE BLEACH.**

To put the head support cover back on, reverse preceding steps.

### **Seat Pad**

Clean with a damp sponge using mild soap and cool water. If needed, pad may be removed for cleaning.

To remove seat pad undo the two snaps on the front of the seat pad.

Undo the fabric below the cup holders.

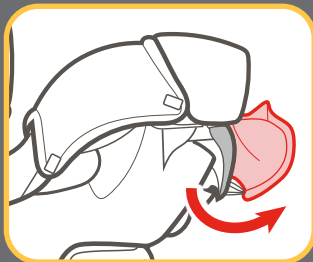
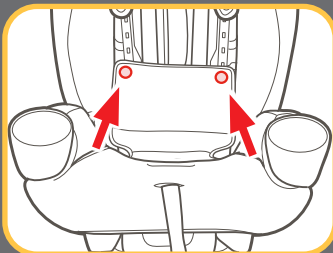
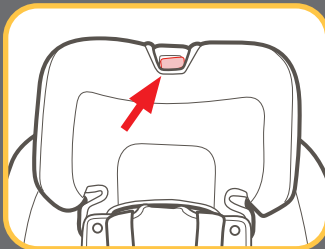

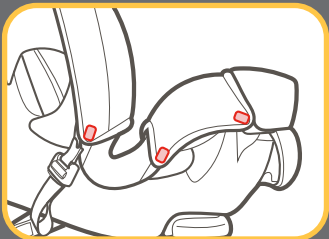

Undo the 3 seat pad hooks on both sides of the car seat.

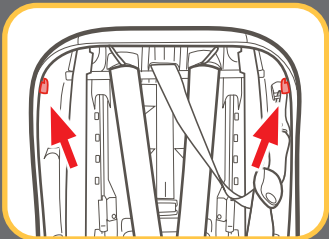

From the back of the car seat, undo the clips on each side.

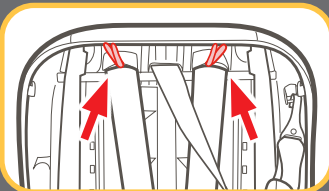

Undo elastic loops on the back of the seat.

Undo the loops on the front of the seat below the cup holders.

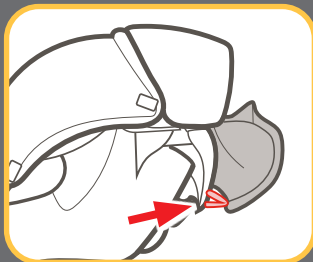

Machine wash pad in cold water with gentle soap on delicate cycle and drip-dry. **DO NOT USE BLEACH.** Reverse the steps to reattach the pad to the shell. Make sure harness straps are not twisted.

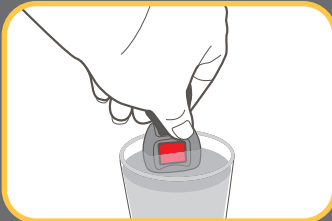
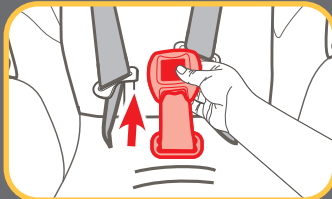
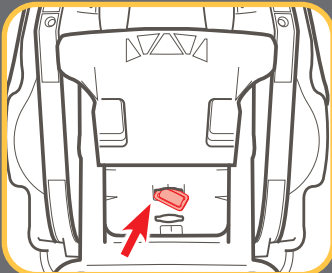

### **Remove Buckle to Clean**

From the bottom of car seat, insert the buckle's metal clip up through shell and pad. From the front, pull buckle out of the pad and shell.

To clean, place in a cup of warm water and gently agitate the buckle. Press the red button several times while in the water.

**DO NOT SUBMERGE THE BUCKLE STRAP.**  
**DO NOT USE SOAPS, HOUSEHOLD DETERGENTS or LUBRICANTS.**

Shake out excess water and allow to air dry. Repeat steps as needed until it fastens with a click. Re-insert the buckle into the same slot it was removed. Pull up on crotch buckle to make sure it is secured.

**WARNING!** Inspect and clean buckle from time to time to remove any objects or debris that could prevent latching.

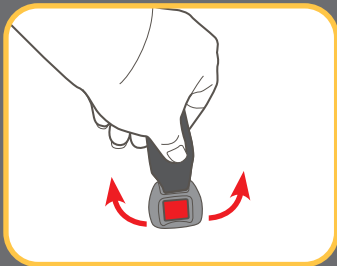



**C****10-C | Cleaning Harness, Lower  
Anchor Attachment and Tether****10**

Surface wash only with mild soap and damp cloth. **DO NOT IMMERSE THE HARNESS STRAPS, LOWER ANCHOR STRAP or TETHER STRAP IN WATER.**

Doing so may weaken the straps.

If harness straps, lower anchor strap or tether strap are frayed or heavily soiled, contact Customer Service at: [www.centurybaby.com](http://www.centurybaby.com) or 1-844-385-0249.



Notes



## Notes

# Replacement Parts

To purchase parts or accessories in the United States,  
please contact us at the following:

**[www.centurybaby.com](http://www.centurybaby.com)**

or

**1-844-385-0249**

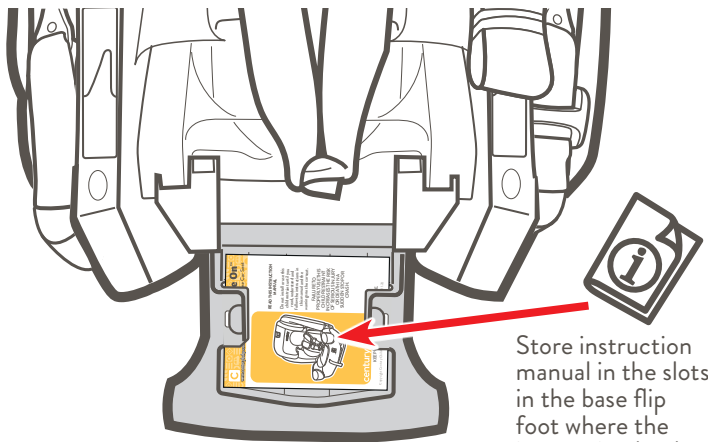

Store instruction manual in the slots in the base flip foot where the instruction book icon is shown.

Flatten Before Recycling		Recycle if Clean & Dry	
PAPER BOX	FOAM INSERTS	PAPER INSERTS	PLASTIC BAG

how2recycle.info

As part of our Do More promise, we encourage everyone to recycle or reuse their cartons and packaging. See below for recycling instructions (from our expert friends at the How2Recycle coalition!) or visit [www.centurybaby.com/domore](http://www.centurybaby.com/domore) for other ideas!