

5 Year Satisfaction Guarantee, see instructional manual for details

Please print legibly. Sunbeam Products, Inc. is a subsidiary of Sunbeam Brands, Inc. (NYSE: NBE). Printed in China. For product questions contact: Sunbeam Products, Inc., USA, 1.800.334.0759 • Canada, 1.800.667.8623 • www.oster.com

Please print legibly. Sunbeam Products, Inc. is a subsidiary of Sunbeam Brands, Inc. (NYSE: NBE). Printed in China. For product questions contact: Sunbeam Products, Inc., USA, 1.800.334.0759 • Canada, 1.800.667.8623 • www.oster.com

1. Mr. Mrs. Ms. Miss Initial Last Name First Name

2. Your Date of Birth _____ / _____ / _____
 Month Day Year

3. Marital Status Married Single

4. Date of Purchase _____ / _____ / _____
 Month Day Year

5. Model Number _____

6. Name of Store Where Purchased _____

7. City _____ State _____ ZIP Code _____

8. Street _____ Apt. No. _____

9. E-mail Address _____

(Please check the box below to receive special offers and promotions from Sunbeam Products, Inc.)
 YES! I want to receive special offers and promotions from Sunbeam Products, Inc.

REGISTER ONLINE AT
www.oster.com/register

OR
fill out this registration card and return by mail to
Oster® Designed for Life®
P.O. Box 174321
Denver, CO 80217-4321
800-334-0759
or call toll-free
800-334-0759

REGISTER ONLINE AT
www.oster.com/register

or call toll-free
800-334-0759

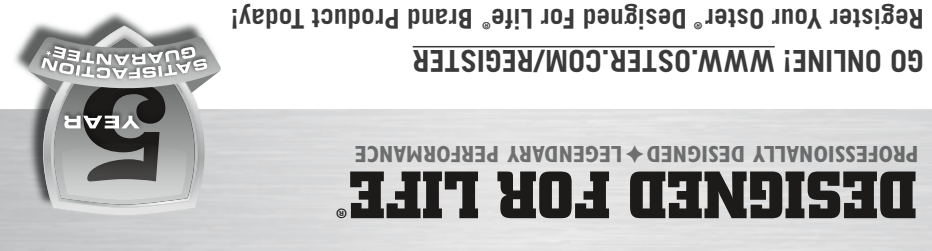

Oster®

User Manual **Extra Large Countertop Oven**
 Manual de Instrucciones **Horno de Mostrador Extra Grande**

MODEL/MODELO **TSSTTVXLDG-003**



It's what we're made of.

For over 100 years, the Oster™ brand has been defining innovation, power and durability. Some say our line of uniquely designed and built appliances last forever. The Oster™ Designed for Life® Series is the next generation of innovative products that are professionally designed, timeless styled and backed by legendary performance.

IMPORTANT SAFEGUARDS

When using electrical appliances, basic safety precautions should always be followed to reduce the risk of fire, electric shock, and/or injury to persons including the following:

- Read all instructions before using this product.
- This appliance generates heat during use. Do not touch hot surfaces. Use handles or knobs. Always protect your hands with non-slip oven mitts or similar. To protect against electric shock, do not place or immerse cord, plugs, or appliance in water or other liquid.
- This appliance is not to be used by children or by persons with reduced physical, sensory or mental capabilities. Close supervision is necessary when any appliance is used near children. Children should not play with the appliance.
- Unplug from outlet when not in use, before putting on or taking off parts and before cleaning. Allow to cool before putting on or taking off parts, and before cleaning. To disconnect, turn any control to OFF, then unplug power cord from outlet. Do not disconnect by pulling on cord. Always grasp the plug and pull to disconnect.
- Do not operate any appliance with a damaged cord or plug or after the appliance malfunctions, or has been damaged in any manner. Do not attempt to replace or splice a damaged cord. Return appliance to the manufacturer (see warranty) for examination, repair or adjustment.
- The use of accessory attachments not recommended by the appliance manufacturer may cause injuries.
- Do not use outdoors or for commercial purposes.
- Do not let cord hang over edge of table or counter, or touch hot surfaces.
- Do not place on or near wet surfaces, or heat sources such as a hot gas or electric burner, or in a heated oven.
- Extreme caution must be used when moving an appliance or removing a pan, containing hot oil or other hot liquids. Always protect your hands with non-slip oven mitts or similar.
- Do not use appliance for other than intended use. Misuse can cause injuries. Intended for household countertop use only. Keep 6 inches (152 mm) clear from the wall and on all sides. Always use appliance on a dry, stable, level surface. Oversize foods or metal utensils must not be inserted in a toaster-oven as they may create a fire or risk of electric shock.
- A fire may occur if the toaster-oven is covered, touching or near flammable materials, including curtains, draperies, towels, walls, and the like, when in operation. Do not store any item on top of the appliance when in operation.
- Do not clean with metal scouring pads. Pieces can break off the pad and touch electrical parts, creating a risk of electric shock.
- Extreme caution should be exercised when using containers constructed of materials other than metal or glass.
- Do not store any materials, other than manufacturers recommended accessories, in this oven when not in use.
- Do not place any of the following materials in the oven: paper, cardboard, plastic, or any materials that may catch fire or melt.

Using Your Countertop Oven

Setting the Clock
 Push the Clock button. The clock will flash. Use the arrow keys to set the hour. Push the Clock button again. Use the arrow keys to set the minutes. Push the Clock button once more or the start button and the time will be set.

Preheating the Oven
 Place oven rack into the desired position before heating the oven. (See "Positioning Rack" Section)
 Push the Bake button. Use arrows to set desired temperature. Push Timer ∇ down button until seven (7) minutes is displayed. Push the Start button.

To Use the Bake Function
 Place oven rack into the desired position before heating the oven. (See "Positioning Rack" Section)
 Arrange food on the wire rack or in the baking pan. Push the Bake button. Use the Temperature arrow keys to select desired temperature. Use the Time arrow keys to select desired time. Push the Start button.

NOTE – Upper and lower heating elements will cycle ON and OFF to maintain the desired temperature, and may not glow. When baking is completed, open door fully and remove food carefully.

To Use the Convection Fan Bake Function
 When you select the Convection Bake the convection fan will turn on and circulate air allowing the food to cook evenly and faster. Place oven rack into the desired position before heating the oven. (See "Positioning Rack" Section)
 Arrange food on the wire rack or in the baking pan. Push the Convection Bake button until "Convection Bake" lights up on display. Use the Temp arrow keys to select desired temperature. Push Timer arrow keys to select desired time. Push the Start button.

NOTE – Both heating elements will cycle ON and OFF to maintain the desired temperature, and may not glow. When baking is completed, open door fully and remove food carefully.

To Use the Broil Function
 Place oven rack into the desired position before heating the oven. (See "Positioning Rack" Section)
 Place broil rack in oven. Push Broil button until the word "Broil" lights up on display. Push Timer arrows to select the desired time. Push the Start button. **NOTE** – The top heating element will cycle ON and OFF to maintain desired temperature, and may not glow. When broiling is completed, open door fully and remove food carefully. **WARNING: DO NOT LEAVE COUNTERTOP OVEN UNATTENDED.**

- Do not cover crumb tray or any part of the oven with metal foil. This will cause overheating of the oven.
- Empty the crumb tray after each use.
- The glass door is made of tempered glass. Always inspect the glass door for chips, cracks or any other damage. Do not use the countertop oven if the glass door is damaged, as the glass may shatter during use.
- Do not use with a programmer, timer, wireless plug adapter or outlet that allows control remotely, or connect to a circuit that is regularly switched on and off by the utility.

SAVE THESE INSTRUCTIONS

HOUSEHOLD USE ONLY

North American models with polarized plugs:

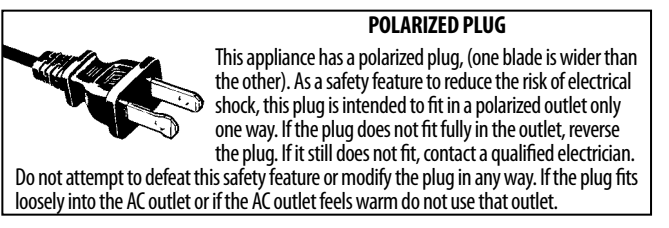

POWER CORD INSTRUCTIONS:
 A short power-supply cord or detachable power-supply cord is provided to reduce risks resulting from becoming entangled in or tripping over a longer cord. Longer detachable power-supply cords or extension cords are available and may be used if care is exercised in their use. If a long detachable power-supply cord or extension cord is used:

- The marked electrical rating of the cord set or extension cord should be at least as great as the electrical rating of the appliance;
- The cord should be arranged so that it will not drape over the countertop or tabletop where it can be pulled on by children or tripped over unintentionally; and
- If the appliance is of the grounded type, the cord set or extension cord should be a grounding-type 3-wire cord.

Do not pull, twist or otherwise abuse the power cord.

NOTICES

- Some countertop and table surfaces are not designed to withstand the prolonged heat generated by certain appliances. Do not set the heated unit on a finished wood table. We recommend placing a hot pad or trivet under your countertop oven to prevent possible damage to the surface.
- During initial use of this appliance, some slight smoke and/or odor may be detected. This is normal with many heating appliances and will not recur after a few uses.

To Use the Toast Function
 Place oven rack into the desired position before heating the oven. (See "Positioning Rack" Section)
NOTE – Different types of bread require different settings. Lighter breads and waffles require a lighter setting. Darker breads, muffins, and English muffins require a darker setting. Arrange food on the wire rack. Push the Toast button. Use arrows to select Toast Shade. Press the Start button. When toasting is completed, open door fully and remove food carefully.

To Use the Pizza Function
 Place oven rack into the desired position before heating the oven. (See "Positioning Rack" Section)
 Arrange pizza on the wire rack. Push the Pizza button and 20:00 default time will appear. Use arrow keys to adjust the time as desired. Push the Start button. **NOTE** – The Pizza function temperature is set at 400°F and cannot be adjusted. If different temperature is desired, cancel Pizza function and use Bake function. For 2 Pizzas Place the 2 pizzas on the wire racks. Cook the pizzas for about one-half the recommended time, and then switch the rack positions to allow the pizzas to uniformly cook top and bottom.

Defrosting Function
 When defrosting do not preheat oven. Temperature Control is already set to 150°F. Push the defrost button. Use arrow keys to adjust time. Allow 15 to 20 minutes per side for meats or fish to defrost. Always cook food promptly after thawing. Push the Start button.

Positioning Rack
 To accommodate a wide variety of foods, the oven has 2 racks and two (2) rack positions. (See Figure 5)
 Positioning of the rack will depend on the size of the food and desired browning. Before removing the rack, allow the unit to cool. **PLEASE NOTE** – For best toast and pizza results, position the rack in the top rack position.

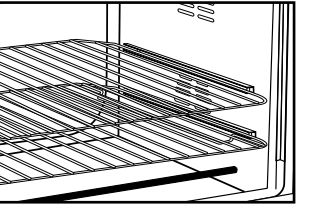

Positioning Pan
 To accommodate a wide variety of foods the oven has two pan positions. The pan can be placed on top of the rack or inserted into the guide rails below the rack. (See Figure Below)
 • Before removing the pan allow the unit to cool.
 • Positioning of the oven pan will depend on the desired cooking method. For baking, place the pan on top of one of the racks. For grilling or broiling, insert the pan into the guide rails below the rack and place the food on top of the rack.

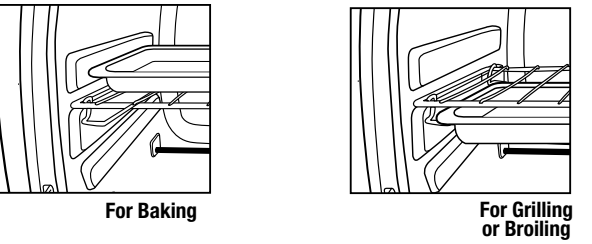

Welcome
 Congratulations on your purchase of an OSTER® Countertop Oven! If you require service on your OSTER® Countertop Oven, do not return to place of purchase. Please contact us at www.oster.com or 1.800.334.0759.

Features of Your Countertop Oven

(See Figure 1)

- Removable Wire Racks/Broil Rack
- Time Display
- Control Buttons
- Two Rack Positions
- Easy Clean Interior Walls
- Glass Door
- Internal Removable Crumb Tray
- Baking Pan

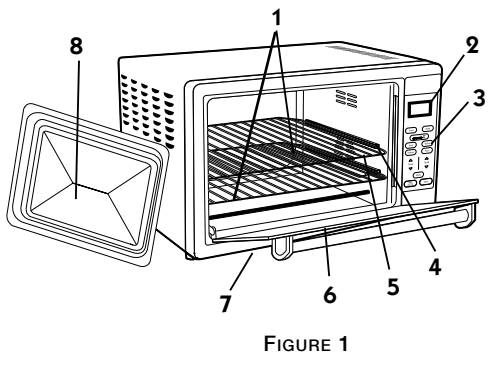

Control Buttons

Function Buttons – (See Figure 2)
 Bake – Convection (Fan Bake), Broil.
 Toast – Select to toast bread, bagels, etc.
 Pizza – Select to bake a large pizza.
 Defrost – Select to defrost foods.
 Timer \wedge ∇ – Adjusts time, temperature or toast shade.
 Temp \wedge ∇ – Adjusts temperature.

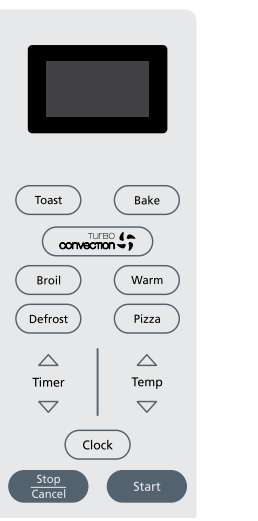

Stop/Cancel – Stops heating or cancels function.
Start – Starts baking/cooking process.
Clock – Sets the Oven Clock.

NOTE – Oven is on when display icons are illuminated and flashing. Pressing Stop/Cancel button twice turns off unit.

Cleaning Your Countertop Oven

Before cleaning your OSTER™ Countertop Oven, press Stop/Cancel button twice, unplug it and allow it to cool. To clean, wipe with damp cloth. **CAUTION: DO NOT IMMERSE IN WATER.** Make sure to use only mild, soapy water. Abrasive cleaners, scrubbing brushes and chemical cleaners will damage the coating on this unit. Empty crumb tray frequently to avoid accumulation of crumbs. Countertop oven racks are dishwasher safe (*top of dishwasher only*). This appliance has no user serviceable parts. Any servicing beyond that described in the Cleaning Section should be performed by an Authorized Service Representative only. See Warranty Section.

Storing Your Countertop Oven

Allow the appliance to cool completely before storing. If storing the countertop oven for long periods of time make certain that the countertop oven is clean and free of food particles. Store the countertop oven in a dry location such as on a table or countertop or cupboard shelf. Other than the recommended cleaning, no further user maintenance should be necessary.

HELPFUL TIPS / TROUBLESHOOTING		
PROBLEM	POTENTIAL CAUSE	SOLUTION
• Overcooked / Undercooked Foods	• Incorrect temperature or time setting • Rack placement	• You may have to adjust the time and temperature to desired taste. • Because your countertop oven is smaller than your regular oven, it will heat up faster and generally cook in shorter periods of time. • Refer to "Positioning Rack" Section, Page English-4. Rack may need to be adjusted to accommodate food type.
• Burnt Smell	• Food build-up inside oven, on heating elements or in crumb tray.	• Refer to "Cleaning Your Countertop Oven" Section, Page English-5.
• Oven does not turn ON	• Unit is unplugged • Did not press Start.	• Plug the countertop oven into a 120-volt AC electrical outlet. • Set timer knob and temperature knob to desired setting. Both must be turned on to operate the countertop oven. • Press Start.
• Only one heating element is heating up	• Function setting selection determines which heating element will operate.	• When toasting, make sure the oven is not set to broil setting.
• Heating elements do not stay ON	• Heating elements will cycle ON and OFF to maintain proper heat.	• Be certain that function is as desired. • Heating elements may not glow.
• Cannot change function button	• Need to cancel function.	• Press cancel.

Preparing To Use Your Countertop Oven for the First Time
 If you are using your countertop oven for the first time, please be sure to: Remove any stickers from the surface of the oven. Open oven door and remove all printed documents and paper from inside the countertop oven. Clean the rack, tray, and pan with hot water, a small amount of dishwashing liquid and a non-abrasive sponge or cleaning pad. **CAUTION: DO NOT IMMERSE THE BODY OF THE UNIT IN WATER.** Dry the unit thoroughly before using. Select a location for the countertop oven. The location should be in an open area on a flat counter where the plug will reach an outlet. Plug the countertop oven into a 120 Volt AC electrical outlet.

To Open the Oven Door:

Step 1: Grab the center of the handle underhanded with fingertips (See Figure 3).

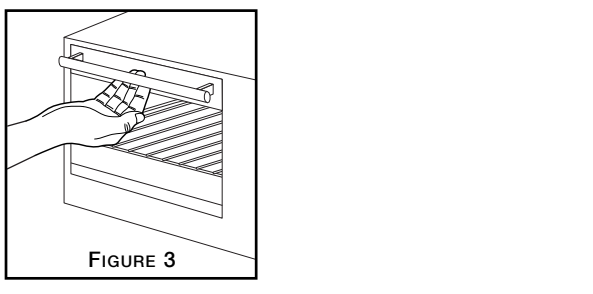

Step 2: Pull down the oven door carefully (See Figure 4).

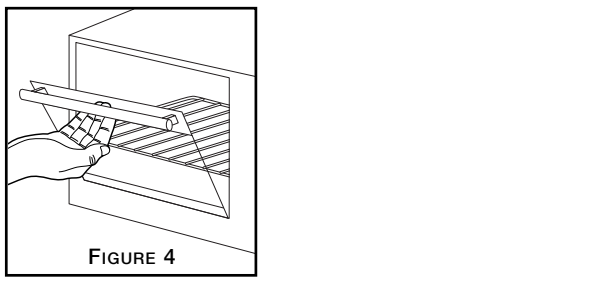

CAUTION: This appliance generates heat during use. Do not touch hot surfaces. Always use handles or knobs per above instructions.

5 Year Satisfaction Guarantee

Sunbeam Products, Inc., or if in Canada, Sunbeam Corporation (Canada) Limited, (collectively "Sunbeam") warrants that for a period of five years from the date of purchase, this product will be free from defects in material and workmanship. Sunbeam, at its option, will repair or replace this product or any component of the product found to be defective during the guarantee period. Replacement will be made with a new or remanufactured product or component. If the product is no longer available, replacement may be made with a similar product of equal or greater value. This is your exclusive guarantee. Do NOT attempt to repair or adjust any electrical or mechanical functions on this product. Doing so will void this guarantee. This guarantee is valid for the original retail purchaser from the date of initial retail purchase and is not transferable. Keep the original sales receipt. Proof of purchase is required to obtain satisfaction guarantee performance. Sunbeam dealers, service centers, or retail stores selling Sunbeam products do not have the right to alter, modify or any way change the terms and conditions of this guarantee.

This guarantee does not cover damage resulting from any of the following: negligent use or misuse of the product, use on improper voltage or current, use contrary to the operating instructions, disassembly, repair or alteration by anyone other than Sunbeam or an authorized Sunbeam service center. Further, the guarantee does not cover: Acts of God, such as fire, flood, hurricanes and tornadoes.

What are the limits on Sunbeam's Liability?
 Sunbeam shall not be liable for any incidental or consequential damages caused by the breach of any express, implied or statutory guarantee or condition. Except to the extent prohibited by applicable law, any implied guarantee or condition of merchantability or fitness for a particular purpose is limited in duration to the duration of the above guarantee. Sunbeam disclaims all other guarantees, conditions or representations, express, implied, statutory or otherwise. Sunbeam shall not be liable for any damages of any kind resulting from the purchase, use or misuse of, or inability to use the product including incidental, special, consequential or similar damages or loss of profits, or for any breach of contract, fundamental or otherwise, or for any claim brought against purchaser by any other party.

Some provinces, states or jurisdictions do not allow the exclusion or limitation of incidental or consequential damages or limitations on how long an implied guarantee lasts, so the above limitations or exclusion may not apply to you. This guarantee gives you specific legal rights, and you may also have other rights that vary from province to province, state to state or jurisdiction to jurisdiction.

How to Obtain Satisfaction Guarantee Service In the U.S.A.
 If you have any question regarding this guarantee or would like to obtain guarantee service, please call 1-800-334-0759 and a convenient service center address will be provided to you.

In Canada
 If you have any question regarding this guarantee or would like to obtain guarantee service, please call 1-800-667-8623 and a convenient service center address will be provided to you.

In the U.S.A., this guarantee is offered by Sunbeam Products, Inc., located in Boca Raton, Florida 33431. In Canada, this guarantee is offered by Sunbeam Corporation (Canada) Limited, located at 20 B Hereford Street, Brampton, Ontario L6Y 0M1. If you have any other problem or claim in connection with this product, please write to the Consumer Service Department.

PLEASE DO NOT RETURN THIS PRODUCT TO ANY OF THESE ADDRESSES OR TO THE PLACE OF PURCHASE.

