

WARRANTY INFORMATION

3 YEAR LIMITED WARRANTY

Sunbeam Products, Inc. doing business as Jarden Consumer Solutions or if in Canada, Sunbeam Corporation (Canada) Limited doing business as Jarden Consumer Solutions (collectively "JCS") warrants that for a period of three years from the date of purchase, this product will be free from defects in material and workmanship. JCS, at its option, will repair or replace this product or any component of the product found to be defective during the warranty period. Replacement will be made with a new or remanufactured product or component. If the product is no longer available, replacement may be made with a similar product of equal or greater value. This is your exclusive warranty. Do NOT attempt to repair or adjust any electrical or mechanical functions on this product. Doing so will void this warranty.

This warranty is valid for the original retail purchaser from the date of initial retail purchase and is not transferable. Keep the original sales receipt. Proof of purchase is required to obtain warranty performance. JCS dealers, service centers, or retail stores selling JCS products do not have the right to alter, modify or any way change the terms and conditions of this warranty.

This warranty does not cover normal wear of parts or damage resulting from any of the following: negligent use or misuse of the product, use on improper voltage or current, use contrary to the operating instructions, disassembly, repair or alteration by anyone other than JCS or an authorized JCS service center. Further, the warranty does not cover: Acts of God, such as fire, flood, hurricanes and tornadoes.

What are the limits on JCS's Liability?

JCS shall not be liable for any incidental or consequential damages caused by the breach of any express, implied or statutory warranty or condition.

Except to the extent prohibited by applicable law, any implied warranty or condition of merchantability or fitness for a particular purpose is limited in duration to the duration of the above warranty.

JCS disclaims all other warranties, conditions or representations, express, implied, statutory or otherwise.

JCS shall not be liable for any damages of any kind resulting from the purchase, use or misuse of, or inability to use the product including incidental, special, consequential or similar damages or loss of profits, or for any breach of contract, fundamental or otherwise, or for any claim brought against purchaser by any other party.

Some provinces, states or jurisdictions do not allow the exclusion or limitation of incidental or consequential damages or limitations on how long an implied warranty lasts, so the above limitations or exclusion may not apply to you.

This warranty gives you specific legal rights, and you may also have other rights that vary from province to province, state to state or jurisdiction to jurisdiction.

How to Obtain Warranty Service

In the U.S.A.

If you have any questions regarding this warranty or would like to obtain warranty service, please visit our website at www.holmesproducts.com.

In Canada

If you have any questions regarding this warranty or would like to obtain warranty service, please visit our website at www.holmesproducts.com.

WARRANTY INFORMATION

In the U.S.A., this warranty is offered by Sunbeam Products, Inc. doing business as Jarden Consumer Solutions located in Boca Raton, Florida 33431. In Canada, this warranty is offered by Sunbeam Corporation (Canada) Limited doing business as Jarden Consumer Solutions, located at 20 B Hereford Street, Brampton, Ontario L6Y 0M1. If you have any other problem or claim in connection with this product, please write our Consumer Service Department. **PLEASE DO NOT RETURN THIS PRODUCT TO ANY OF THESE ADDRESSES OR TO THE PLACE OF PURCHASE.**

© 2013 Sunbeam Products, Inc. doing business as Jarden Consumer Solutions. All Rights Reserved.
Distributed by Sunbeam Products, Inc. doing business as Jarden Consumer Solutions, Boca Raton, Florida 33431.

153966 Rev A
GCDS-HOL28204-PH

HT38_13EM1

Printed In China

Holmes®

Owner's Guide

HT38



Slim Profile

Tower Fan

PLEASE READ AND SAVE THESE IMPORTANT INSTRUCTIONS

PLEASE READ AND SAVE THESE IMPORTANT SAFETY INSTRUCTIONS

When using electrical appliances, basic safety precautions should always be taken including the following:

1. Read all instructions before using this appliance.
2. Use fan only for purposes described in the instruction manual.
3. To protect against electrical shock do not immerse unit, plug or cord in water or spray with liquids and plug the appliance directly into a 120V AC electrical outlet.
4. Close supervision is necessary when any appliance is used by or near children.
5. Unplug from outlet when not in use, when moving fan from one location to another, before putting on or taking off parts and before cleaning.
6. Avoid contact with moving parts.
7. Do not operate in the presence of explosive and/or flammable fumes.
8. To avoid fire hazard, NEVER place the cord under rugs or any parts near an open flame, cooking or other heating appliance.
9. Do not operate any appliance with a damaged cord or plug after the appliance malfunctions, or has been dropped/damaged in any manner. Discard fan or return to an authorized service facility for examination and/or repair.
10. Do not run cord under carpeting. Do not cover cord with throw rugs, runner, or similar coverings. Do not route cord under furniture or appliances. Arrange cord away from traffic area and where it will not be tripped over.
11. The use of attachments not recommended or sold by the appliance manufacturer may cause hazards.
12. Do not let the cord hang over the edge of a table, counter or come in contact with hot surfaces or leave exposed to high traffic areas.
13. Do not use outdoors.
14. To disconnect, grip plug and pull from wall outlet. Never yank on cord.
15. Always use on a dry, level surface.
16. Do not operate fan until fully assembled with all parts properly in place.
17. This product is intended for household use ONLY and not for commercial or industrial applications.
18. **WARNING:** To reduce the risk of electrical shock and injury to persons, do not use in window.
19. **WARNING:** To reduce the risk of fire or electric shock, do not use this fan with any solid-state speed control device.
20. This product employs overload protection (fuse). A blown fuse indicates an overload or short-circuit situation. If the fuse blows, unplug the product from the outlet. Replace the fuse as per the user servicing instructions (follow product marking for proper fuse rating) and check the product. If the replacement fuse blows, a short circuit may be present and the product should be discarded or returned to an authorized service facility for examination and/or repair.

PLEASE READ AND SAVE THESE IMPORTANT SAFETY INSTRUCTIONS

THIS APPLIANCE HAS A POLARIZED PLUG (one blade is wider than the other). To reduce the risk of electric shock, this plug is intended to fit in a polarized outlet only one way. If the plug does not fit fully in the outlet, reverse the plug. If it still does not fit, contact a qualified electrician to install the proper outlet.

DO NOT ATTEMPT TO MODIFY THIS PLUG OR DEFEAT THIS SAFETY FEATURE IN ANY WAY.

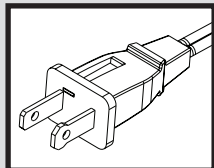

FEATURES - OPERATIONS

ASSEMBLY INSTRUCTIONS

Assembly Time: 5-10 Minutes

Tools Required: Phillips Head Screw Driver



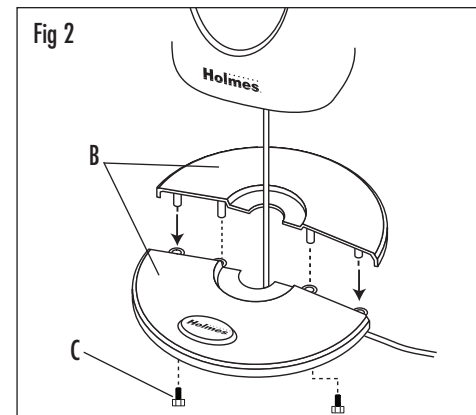
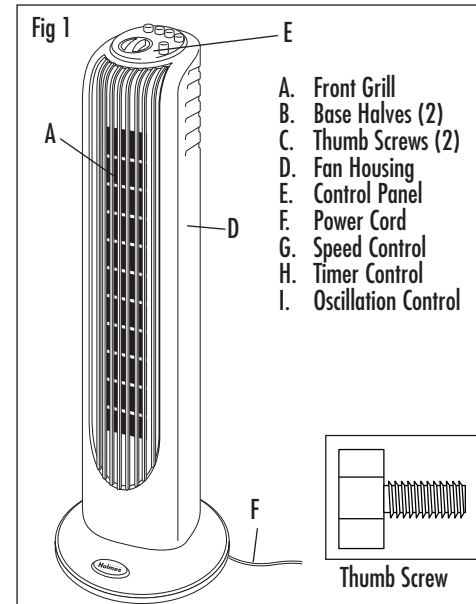

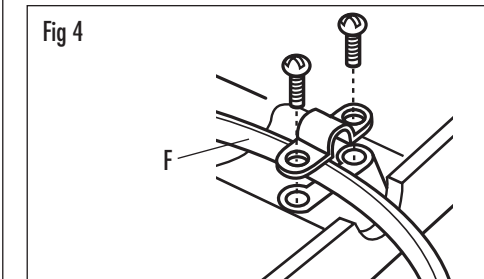
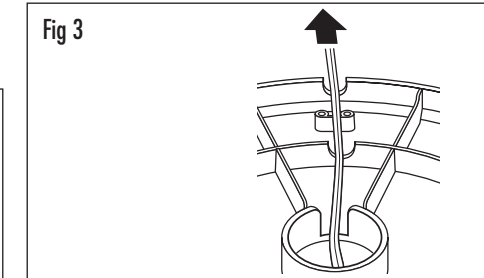

1. Assemble Base Halves around the power cord. Refer to Fig 2.



2. Secure assembled base to the Fan Housing with two thumb screws (Fig 2).
3. Secure Power Cord as shown in Fig 3 & 4.



OPERATING INSTRUCTIONS

1. Set the fan on a dry level surface.
2. Plug cord into any standard 120V AC outlet.
3. To turn the fan on, press the desired SPEED button « I II III » on the Control Panel.
4. To oscillate the fan head, press the OSCILLATION button «  » on the Control Panel. Press a second time to stop oscillation. To turn the fan off, push the off button «  ».
5. To activate the timer feature turn the Timer Control «  » clockwise to your desired duration (0-120 minutes). For continuous running turn the Timer Control «  » to « I ». To turn the fan off, turn the Timer Control «  » to «  » or push the off button «  » on the control panel.

NOTE: Timer must be in « I » position to run continuously.

CLEANING / MAINTENANCE

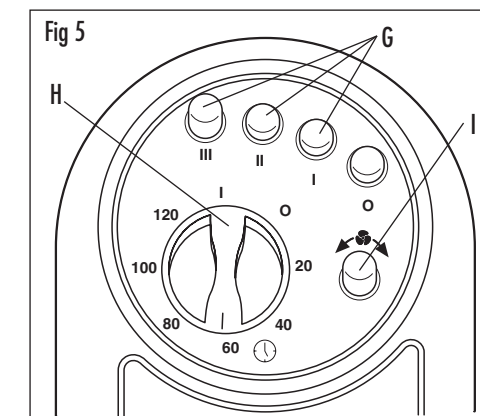

CLEANING / MAINTENANCE INSTRUCTIONS

Follow these instructions to correctly and safely care for your Tower Fan. Please remember:

REPLACEABLE FUSE

If your (5 Amp, 125 Volt) replaceable fuse blows, please visit our website at www.holmesproducts.com for information on how to order a new fuse. Follow the below instructions to replace the fuse on the plug.

User Servicing Instructions

1. Unplug your fan. Grasp plug and remove from the receptacle or other outlet device. Do not unplug by pulling on cord.
2. Open fuse cover, located on the top of the plug, by using your thumb or a flathead screwdriver to slide the cover down towards the prongs.
3. Remove fuse carefully by using a small screwdriver to pry the fuse out of the compartment by the metal ends of the fuse (see Fig 6).
4. Place plug on a solid, flat surface. Insert new 5 Amp,

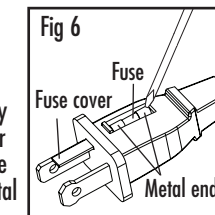

125 Volt fuse into fuse compartment and use a small screwdriver to secure the metal ends of the fuse into the compartment.

Caution: Risk of fire. Replace fuse only with 5 Amp, 125 Volt fuse.

5. Slide fuse cover closed completely. If fuse cover is difficult to close, make sure fuse is secured in place completely by pressing down on metal ends of the fuse.
6. Risk of fire. Do not replace attachment plug. Contains a safety device (fuse) that should not be removed. Discard product if the attachment plug is damaged.

FAN CLEANING

- Always unplug the fan before cleaning.
- Clean the fan with a soft cloth moistened with a mild soap solution.
- Do not allow water to drip on or into the fan motor housing.
- Do not use any of the following as a cleaner: gasoline, thinner, benzene.
- We also recommend the periodic cleaning of this fan by lightly running a vacuum cleaner nozzle over the fan grill to remove any dust or dirt that may have accumulated inside or on the unit.

Using a soft, moist cloth, with or without a mild soap solution, carefully clean the fan base and head. Please use caution around the motor housing area. Do not allow the motor or other electrical components to be exposed to water.

FAN STORAGE

In the off-season, it is important to keep your fan in a safe, dry location.

- We recommend using the original (or appropriately sized) box.
- Please remember to protect the fan from dust or moisture.

If you have any questions regarding your product or would like to learn more about other Holmes® products, please visit our website at www.holmesproducts.com.