















PARTS – remove all the parts from the carton and verify part quantities as indicated on this parts list.

①		CASTER – QTY: 5
②		5-STAR BASE– QTY: 1
③		GAS LIFT– QTY: 1
④		SEAT CUSHION– QTY: 1
⑤		MECHANISM– QTY: 1
⑥		BACK CUSHION– QTY: 1
⑦		ARMREST– QTY: 2
⑧		5/16"x7/8" SCREW: – QTY: 4
⑨		5/16"x1-3/4" SCREW: – QTY: 4
⑩		5/16"x1-1/4" SCREW: – QTY: 4
⑪		PLASTIC CAP– QTY: 4
⑫		ALLEN KEY – QTY: 1
⑬		HANDGRIP – QTY: 2

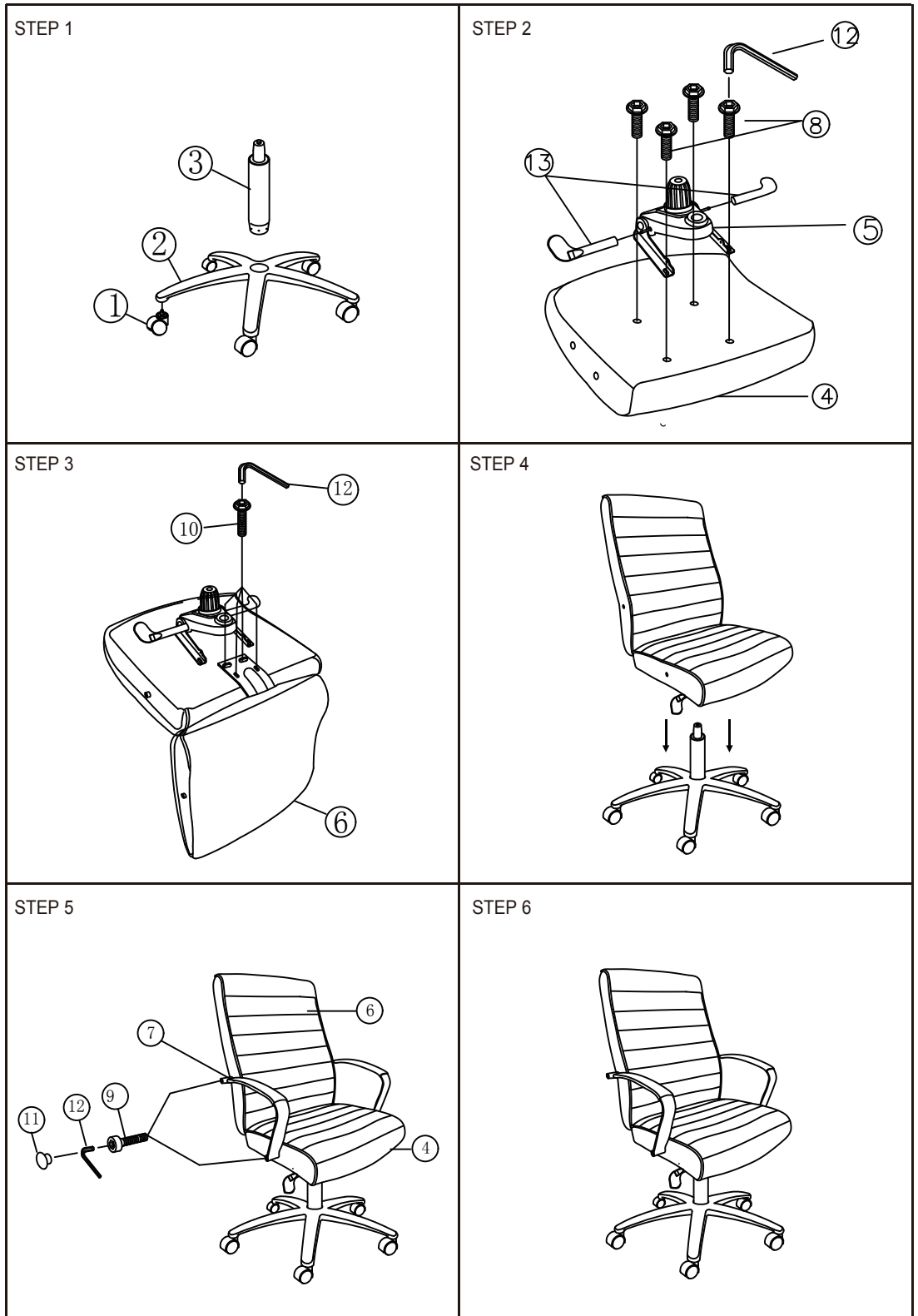

Important: Use this chair for its intended purpose only. This chair is to be used by one person at a time. Do not lean back on 2 wheels or use the chair as a step ladder. Be sure all screws are properly tightened. Save the Allen wrench to periodically tighten the screws in the future, if they become loose.