

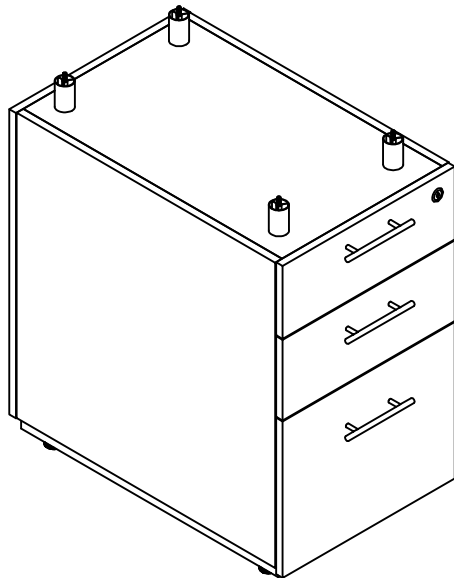









Sterling Series™
Desk Ped BFF 26"
Model No. STEDBBF



ASSEMBLY INSTRUCTIONS

CALL 1-800-822-8037 FOR ASSISTANCE

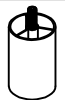
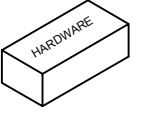
PARTS LIST

Name	Part	Qty.	Name	Part	Qty.
A	 Handle-Silver 96mm Center HB	3	F	 REALS638 M6 Flange Nut HB	5
B	 Handle Screw M4x35mm White REALS410	5	G	 HB REALS639 10mm Wrench	1
C	 Handle Screw M4x22mm White REALS257 Handle and Screw	3	H	 HB Keys	1
D	 HB REALS607 Ø32*50mm Base Stand-off	4		 HARDWARE STEDBBFHB	
E	 HB REALS637 M6 x 35mm	5			

Items with HB are in hardware box.

IMPORTANT!

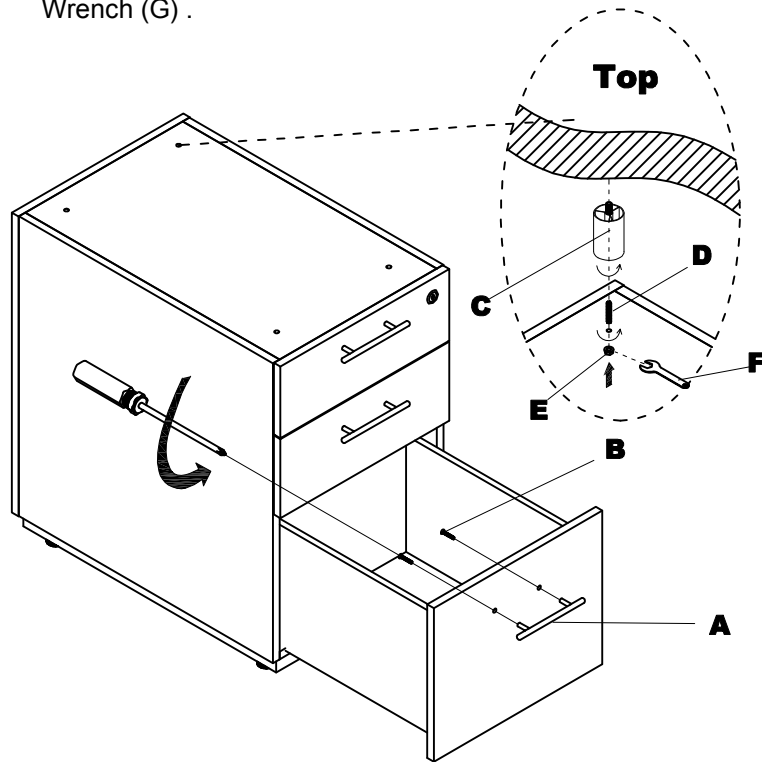

Review ALL instructions before beginning assembly. These instructions are provided to avoid problems that may occur from improper assembly or installation. Mayline and/or its distributor are not responsible for failure resulting from improper assembly or installation of this product. Moreover, all warranties are void for failure to follow these assembly instructions.

- 1** Attach Handles (A) to the Fronts of Drawer using Screws (B). Attach the Stand offs(D) to the Bottom of TOP using screws(F) and Wrench (G) .

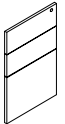

2

Pre-Assembled Replacement Part List

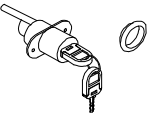
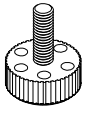
Part	Included Qty.	Part	Included Qty.
 STEDBBFDF**	1	 REALS616 22" Extra Drawer Slides	3
 REALS401 Lock w/ Key	1	 REALS425 Leveler	4

**Denotes Color Code

3