

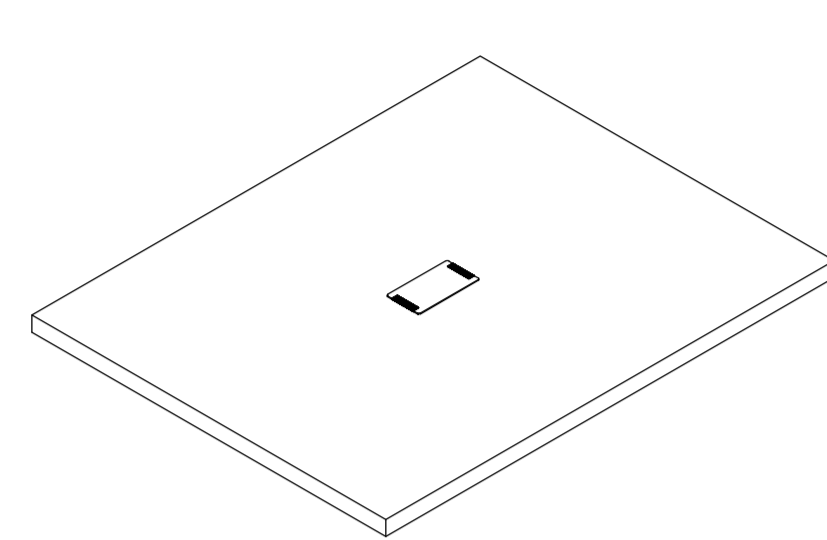

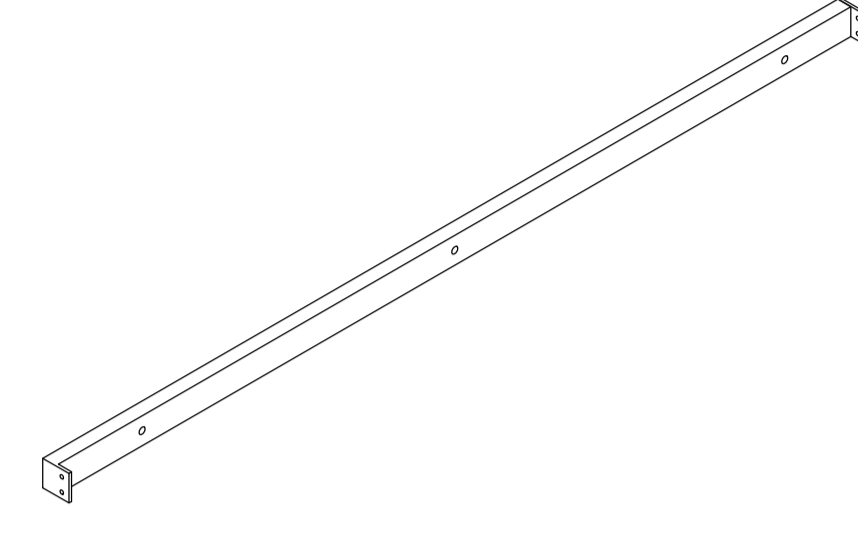

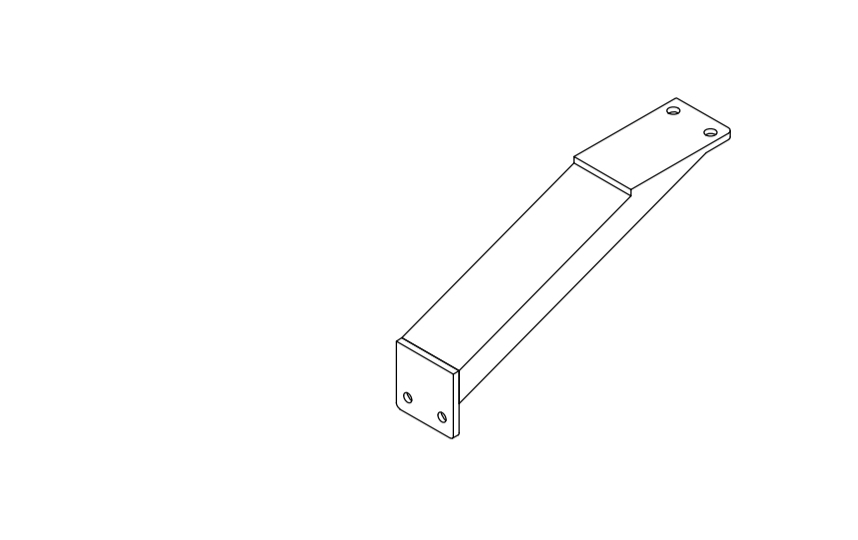

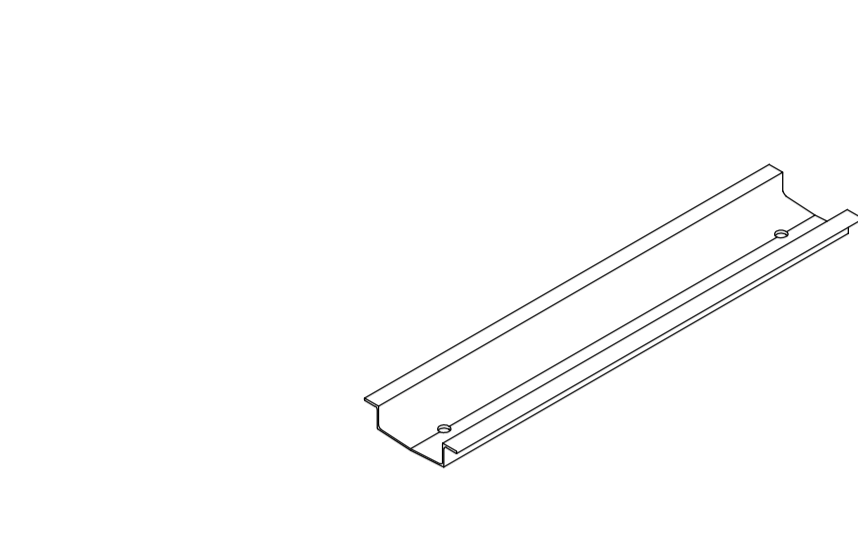
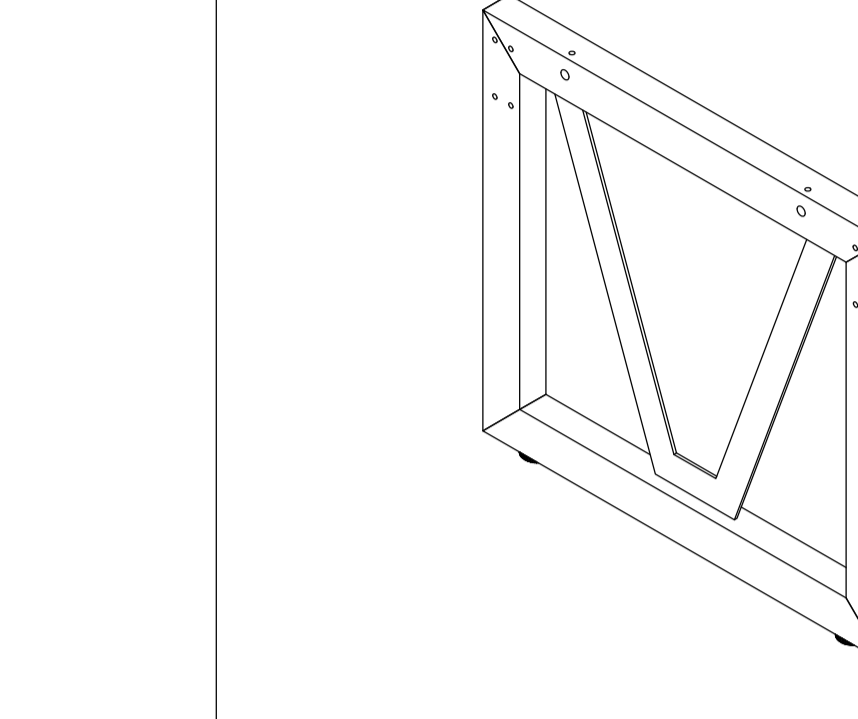
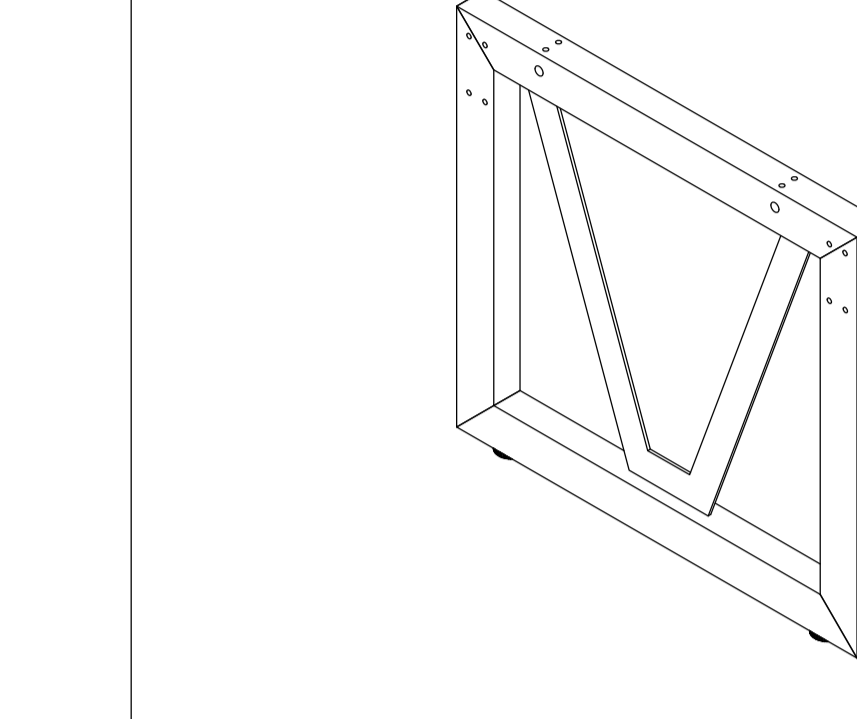
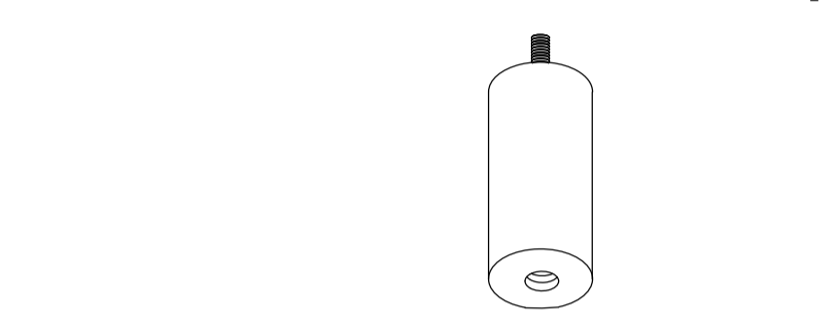

**Congratulations on the purchase of your new *Signature Series* product!**

**COMPONENTS**

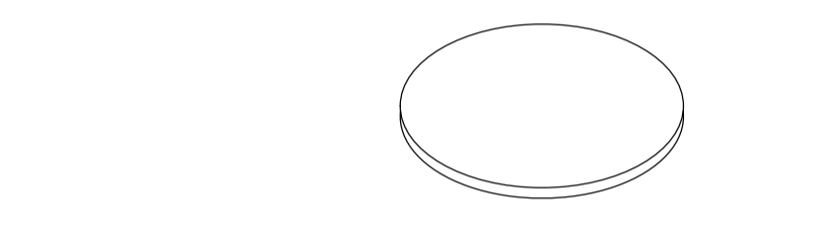
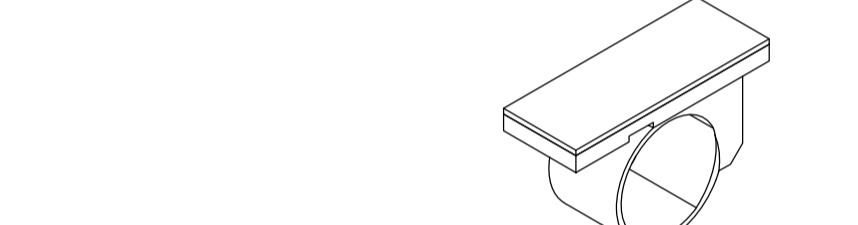
<p><b>A</b> Top Panel -1pc</p> 	<p><b>B</b> Mounting Frame -2pcs</p>  <p>Mounting Frame Length ICT60HT (1048mm) ICT72HT (1356mm) ICT84HT (1661mm) ICT96HT (1948mm)</p>	<p><b>C</b> Corner Crossbar -4pcs</p> 	<p><b>D</b> Wire Management Tray-1pc</p> 	<p><b>ICTBB</b> <b>E</b> Starter Base -2pcs</p> 	<p><b>ICTMBB</b> <b>F</b> Add-on Base -1pc</p> 
---	---	---	--	---	--

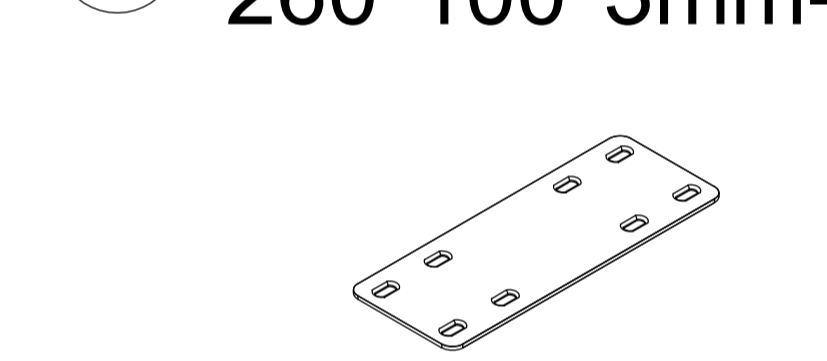
**HARDWARE & TOOLS**

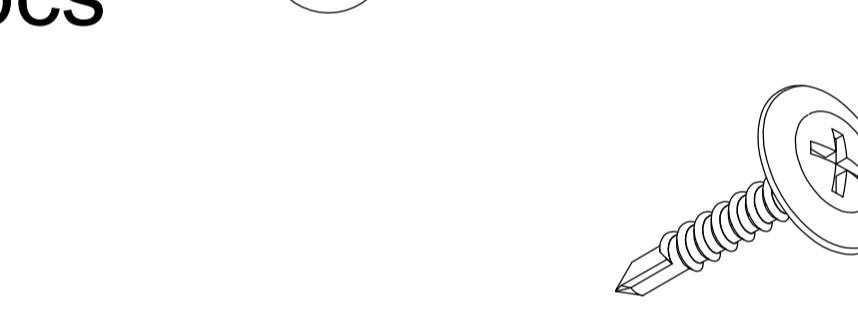
<p><b>G</b> Stand-off Ø20x76mm-2pcs</p> 	<p><b>H</b> Cam Lock-5pcs</p> 	<p><b>I</b> Allen Screw M6X40mm-7pcs</p> 	<p><b>J</b> Cam Post-5pcs</p> 	<p>Tools Required for Assembly</p> 
<p><b>K</b> Cam Sticker-5pcs</p> 	<p><b>L</b> Cable Clip-3pcs</p> 	<p><b>M</b> Allen Wrench 4mm-1pc</p> 	<p><b>N</b> Leveler-2pcs</p> 	<p>Philips Screw Driver for <b>J</b> Cam Post <b>H</b> Cam Lock <b>Q</b> Wood Screw</p>
<p><b>O</b> Mounting Bracket 260*100*3mm-1pc</p> 	<p><b>P</b> Allen Screw M6X20mm-25pcs</p> 	<p><b>Q</b> Wood Screw-8pcs</p> 		

**INSTRUCTIONS - We don't recommend using power tools when installing Cam Posts.**

**STEP 1**

**A**

**J X4**

**D X1**

**N X2**

**G X2**

**Congratulations on the purchase of your new *Signature Series* product!**

**INSTRUCTIONS** - We don't recommend using power tools when installing Cam Posts.

**STEP 4**

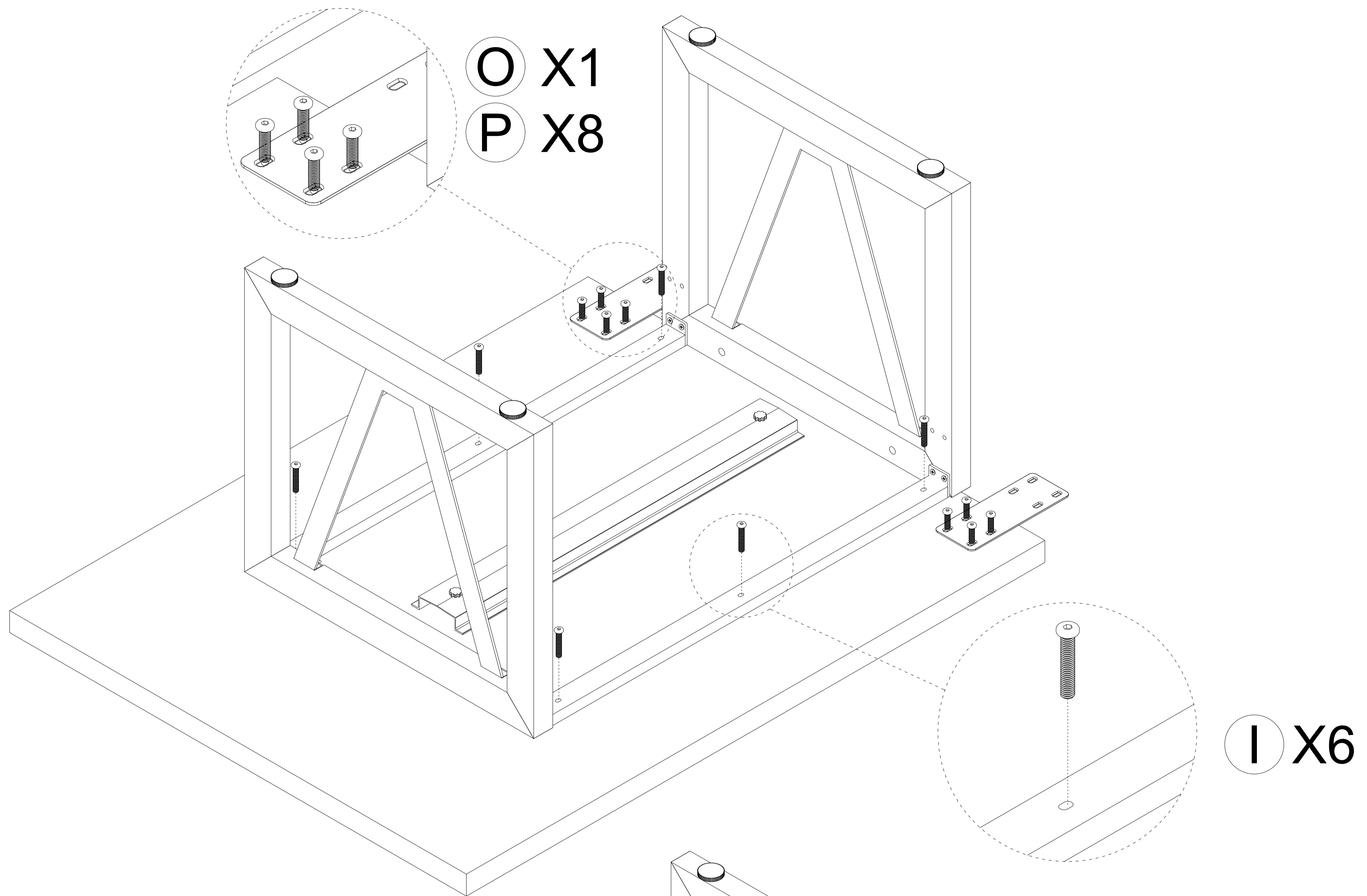

**STEP 5**

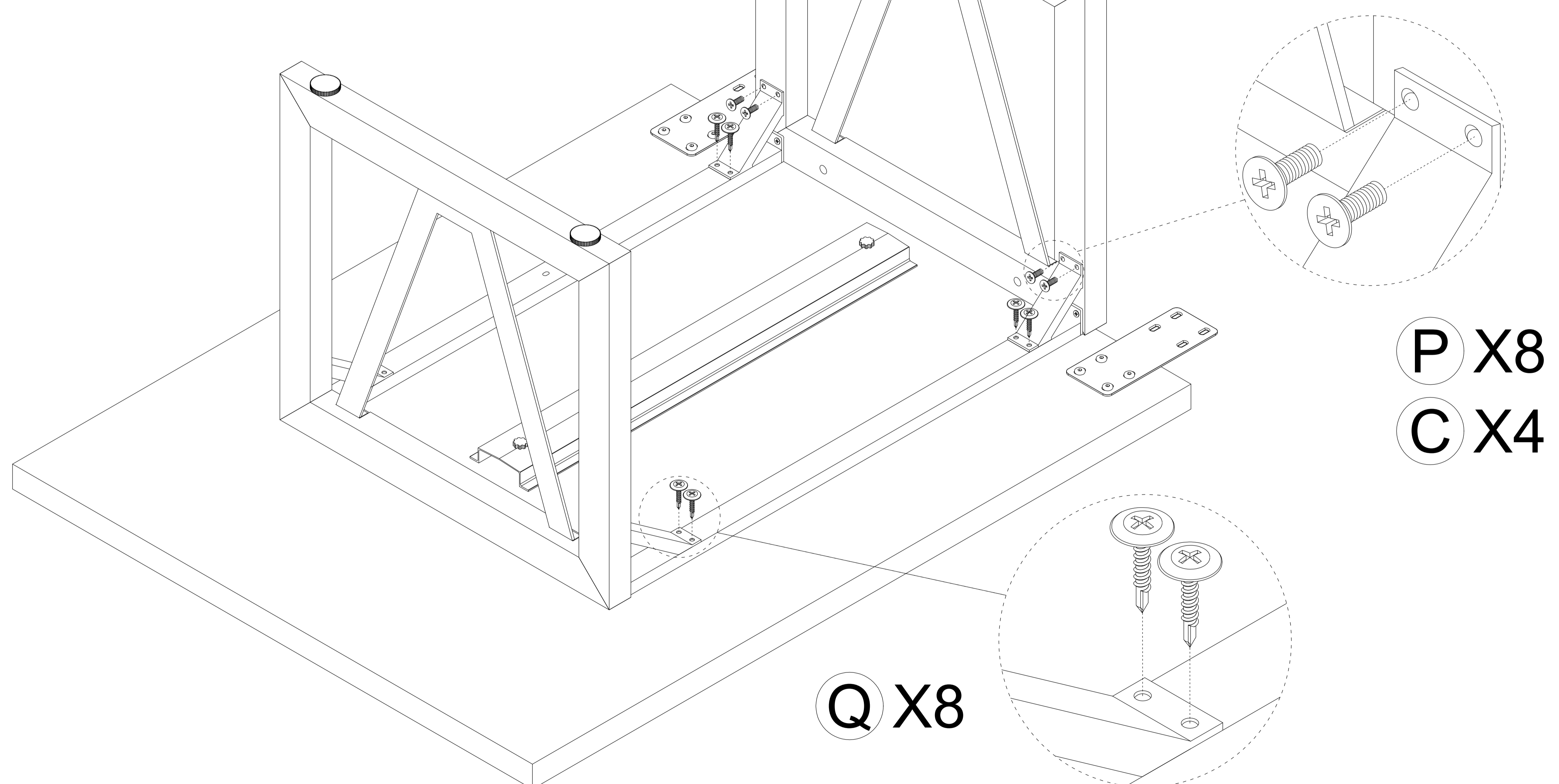

**Same assembled instructions as  
Step 1-5 for another Table Top.**

**Congratulations on the purchase of your new *Signature Series* product!**

**INSTRUCTIONS** - We don't recommend using power tools when installing Cam Posts.

**STEP 2**

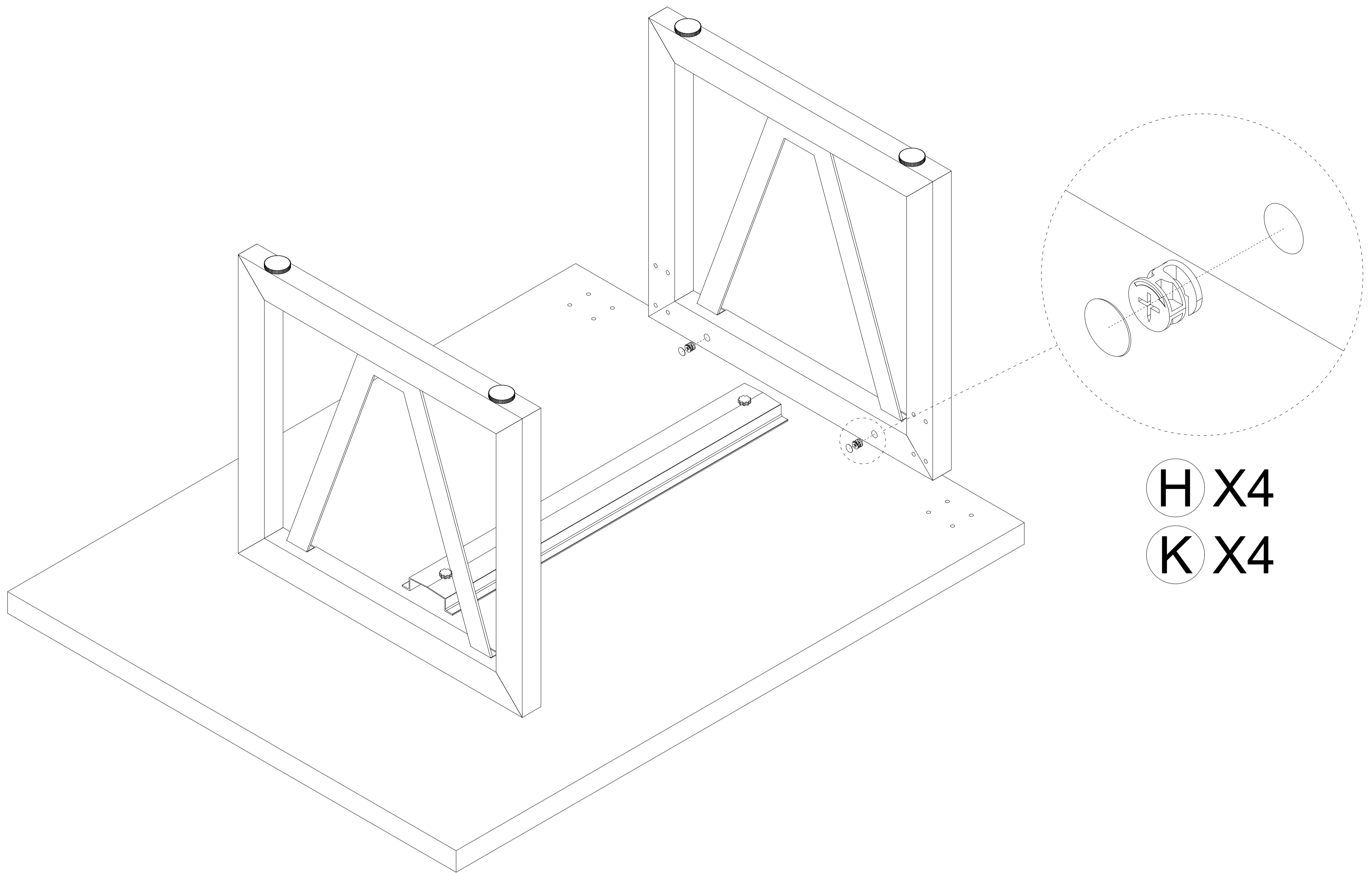

**STEP 3**

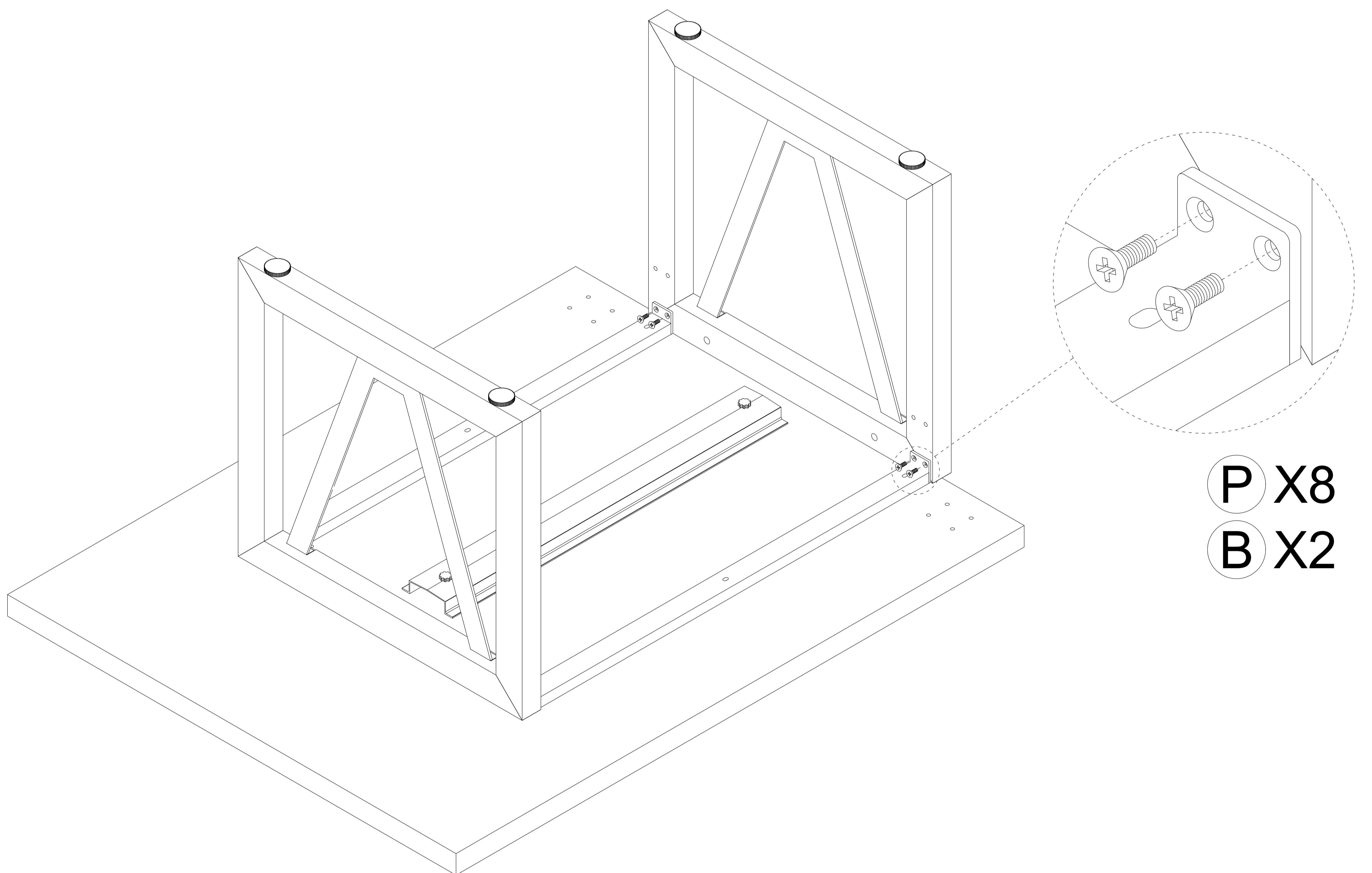

**Congratulations on the purchase of your new *Signature Series* product!**

**INSTRUCTIONS - We don't recommend using power tools when installing Cam Posts.**

**COMPLETED**

