











Assembly Instructions

MODEL NO.: 7224LFC

LATERAL FILE CREDENZA

A: (0)	B: (0)	C: (0)	D: (0)	E: (0)	F: (0)	G: (12)	H: (0)	I: (0)	J: (0)
									

STEP 1

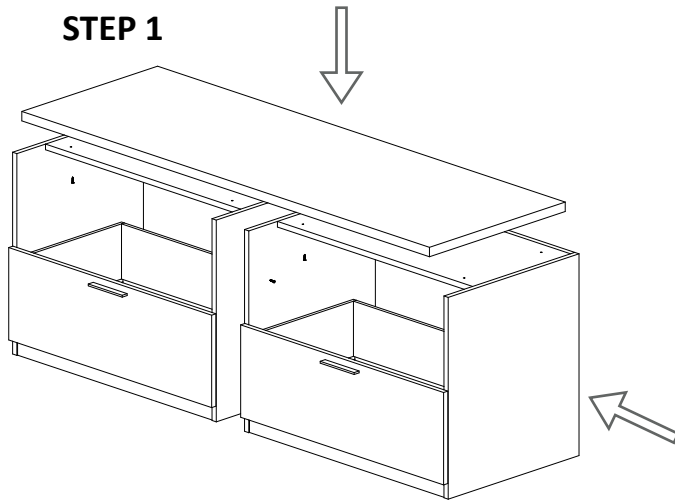

Separate the drawer profile from the middle and cabinet profile by pushing the disconnect finger release trigger to one side while simultaneously pulling it out until it has come all the way out and disconnected.

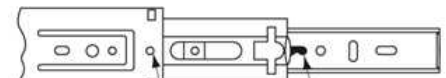

Face frame
screw hole

Finger release trigger

STEP 2

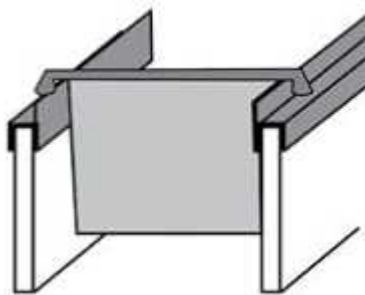

*FILING REFERENCE IMAGE

ADJUST LEVELERS
TO FLOOR

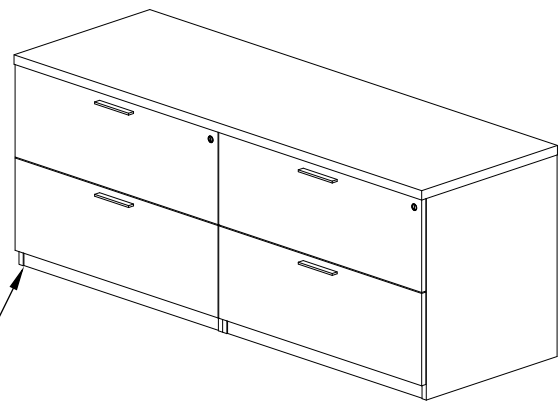

FUNCTION OF CAM



**1/4 RIGHT
TURN FOR
LOCKING**

**MAKE SURE THE ARROW IS POINTING UPWARDS
BEFORE INSERTING INTO THE PANEL'S HOLE.**

IMPORTANT NOTE:

- It is advisable to assemble unit on carpet or blanket to avoid scratches.
- Check to be sure you have all parts and hardware before assembly.
- Do not fully tighten screws/bolts until completely assembled
- 2 persons are recommended to complete assembly.

DISCLAIMER:

Please note that the drawings and illustrations provided in these assembly instructions are for general reference only. They may not exactly represent the specific product you have purchased. Variations in design, appearance, and components may occur due to product updates, manufacturing changes, or regional differences.