









# Assembly Instructions

## MODEL NO.: 4224BS

### BRIDGE SHELLS

A: (3)	B: (3)	C: (4)	D: (2)	E: (2)	F: (1)	G: (0)	H: (0)	I: (0)
								

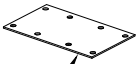
#### STEP 1

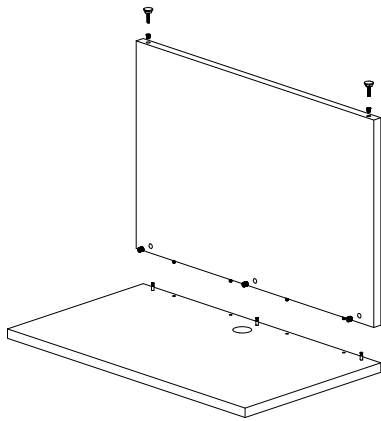

FLAT PLATES  
NEEDED TO  
ATTACH TO  
DESK/RETURN

#### STEP 2

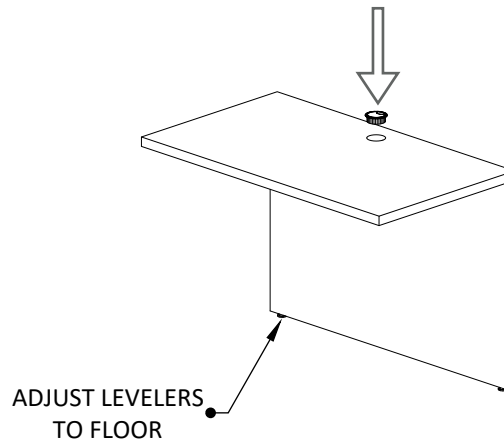

#### IMPORTANT NOTE:

- It is advisable to assemble unit on carpet or blanket to avoid scratches.
- Check to be sure you have all parts and hardware before assembly.
- Do not fully tighten screws/bolts until completely assembled
- 2 persons are recommended to complete assembly.

#### DISCLAIMER:

Please note that the drawings and illustrations provided in these assembly instructions are for general reference only. They may not exactly represent the specific product you have purchased. Variations in design, appearance, and components may occur due to product updates, manufacturing changes, or regional differences.

#### FUNCTION OF CAM



**1/4 RIGHT  
TURN FOR  
LOCKING**

**MAKE SURE THE ARROW IS POINTING UPWARDS  
BEFORE INSERTING INTO THE PANEL'S HOLE.**