

Board Hanging Instructions

This installation guide is used for boards of different sizes, with or without marker trays. You may receive more hardware than required for your installation. Read instructions fully before starting.

NOTE: Wall attachment hardware is NOT provided. The installer to provide proper hardware based upon the wall construction.

NOTE: If the wall is not smooth and flat, notify the customer before installing, the board's warranty may be voided.

Required Quantity of Top L Hangers (Bottom Also if NO Marker Tray):

- 6' Wide or Less: (2) L Hangers
- 8' Wide: (3) L Hangers (Equally Spaced)
- 10' Wide: (4) L Hangers (Equally Spaced)
- 12' Wide: (5) L Hangers (Equally Spaced)

STEP 1: If a marker tray is required, install end caps with a mallet.

STEP 2: Scribe a level line representing the BOTTOM edge of the board.

STEP 3A (Without Tray): Align (2) BOTTOM L Hangers 6" from each end of scribed line, add additional BOTTOM L Hangers based upon the board's width, see above. Position and tighten screw in the top of slot as shown in Figure 3A.

STEP 3B (With Tray): Using the marker tray's guide groove, pre-drill using a 1/8" drill bit every 12". Align and Center the marker tray with the scribed line, mark the tray's hole locations on the wall and secure to wall. If the distance from the end of the tray to the left and right edge is greater than 18", install L Hangers 6" from each end of the scribed line.

STEP 4: Lift and center the board on the marker tray and/or L Hangers. Scribe a line the full TOP width of the board, remove board.

STEP 5: Align (2) TOP L Hangers 6" from each end of scribed line. Add additional TOP L Hangers per above.

IMPORTANT: To allow for expansion/contraction of the board due to seasonal changes, please make sure that:

- A. The TOP mounting screw **MUST** be centered in the slot.
- B. Do **NOT** over tighten the TOP mounting screws, the L Hanger must be allowed to slide with minimal effort.

NOTE: Not following the above steps will void the warranty.

1

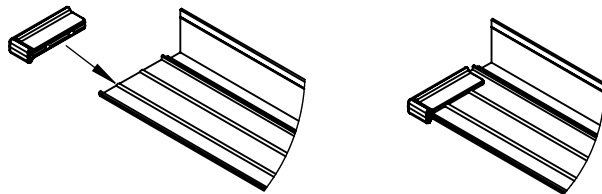

2

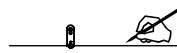

3A

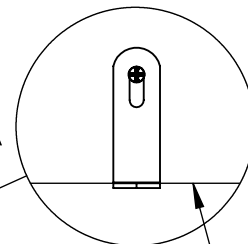

6"

Scribed Bottom Line

3B

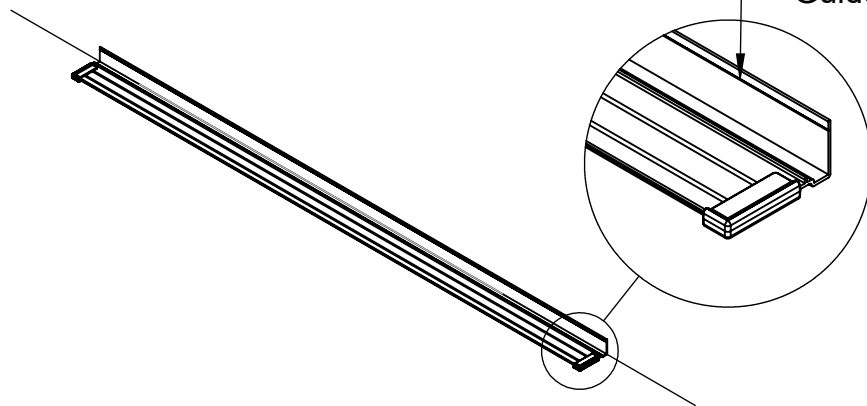

Guide Groove

4

Scribed Line on Top of Board

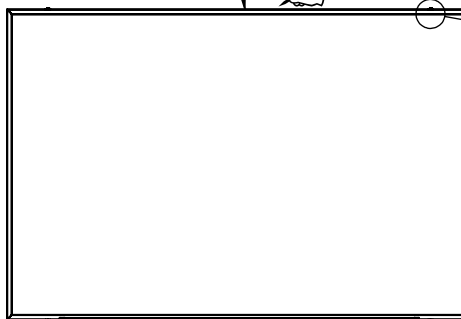

5

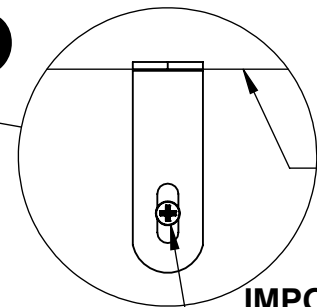

Scribed Top Line

IMPORTANT:
Position screw in the center of slot

STEP 6: Slide the TOP L Hangers UP. Lift and center the board on the marker tray and/or BOTTOM L Hangers.

Slide the TOP L Hangers DOWN until they contact the frame. Using the L-Hanger's holes as a template, mark the top frame; also mark the bottom frame if BOTTOM L Hangers are used.

Remove the board and drill the frame mounting holes using a 1/8" drill bit.

STEP 7: Return board to the wall, secure using the provided #8 x 1/2" screws.

STEP 8: Recycle all packaging in accordance with local regulations.

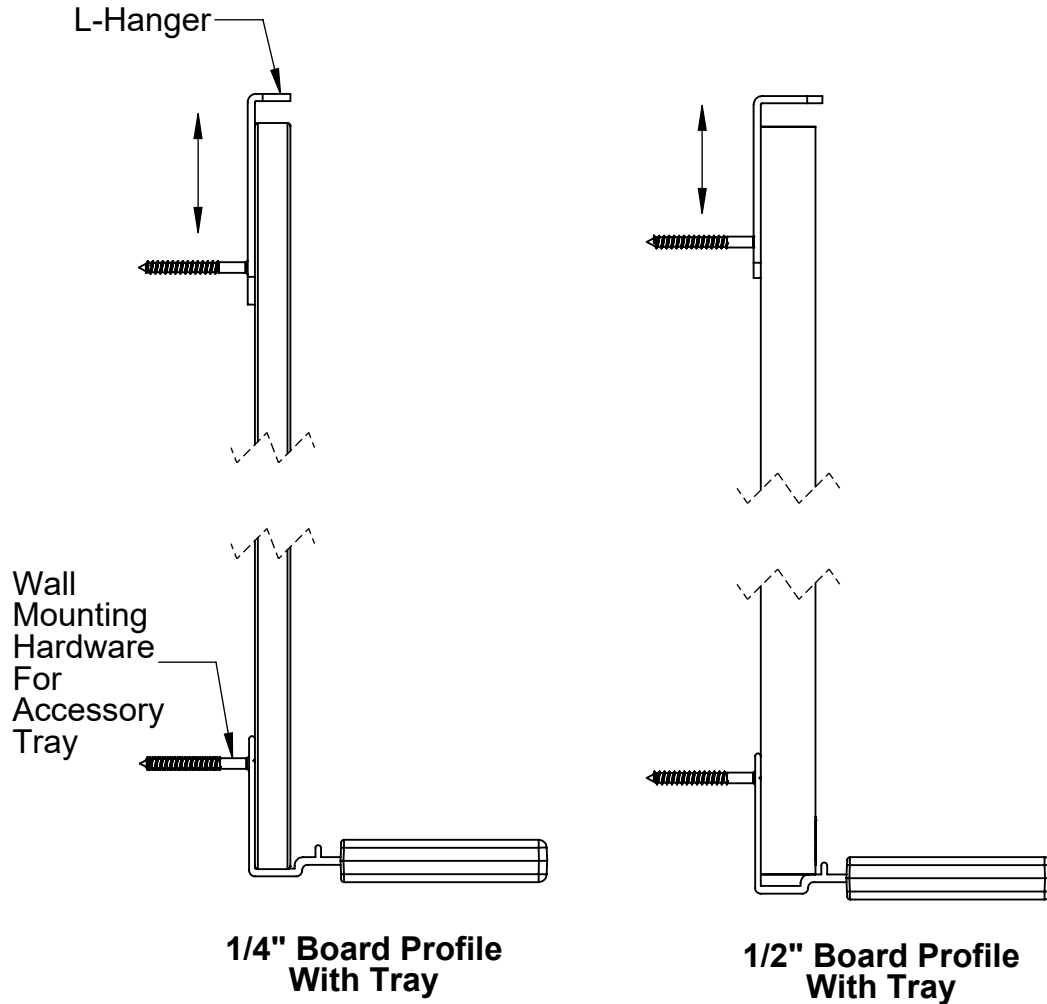

6

