

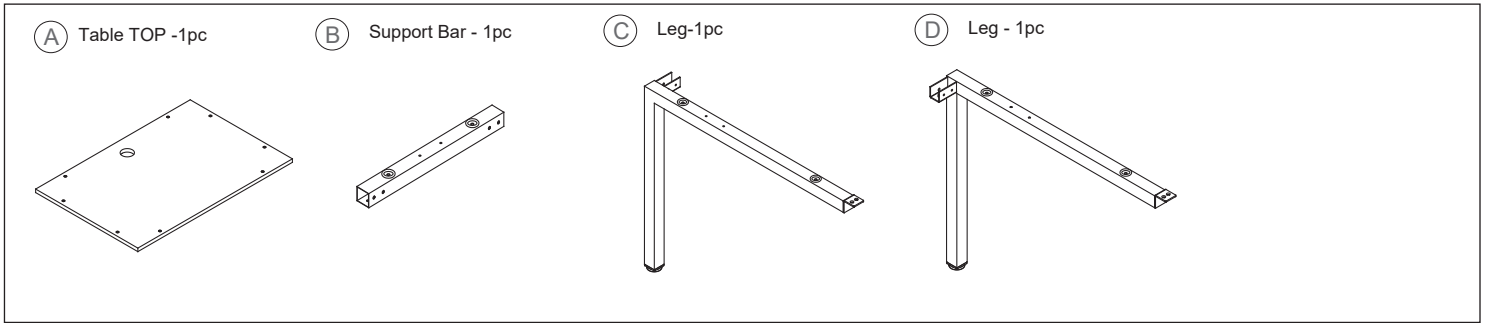

At Work- Return for 72" L Desk Assembly Instructions

COMPONENTS



HARDWARE & TOOLS

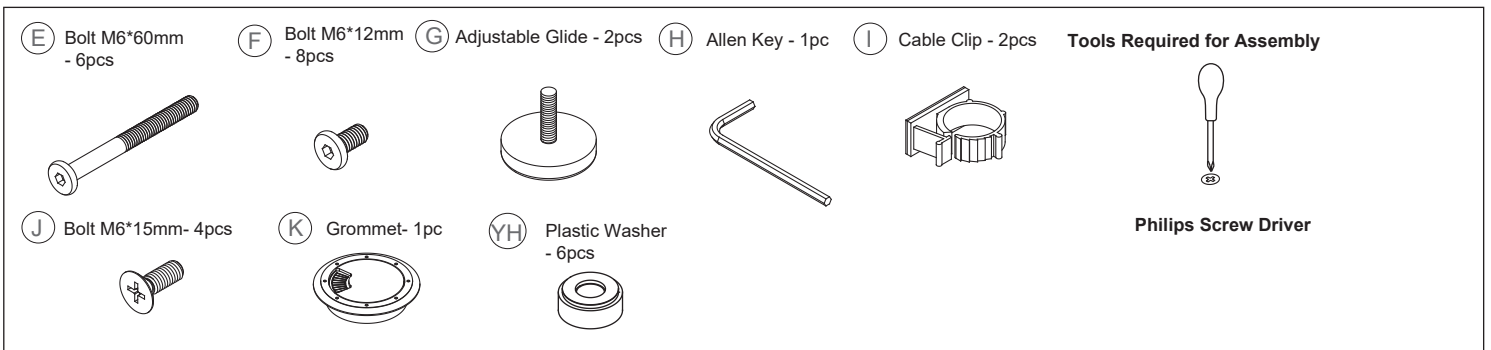

INSTRUCTIONS **Note:**To create an "L"-shape desk,build both return and main desk frames before adding tops.See step 3.

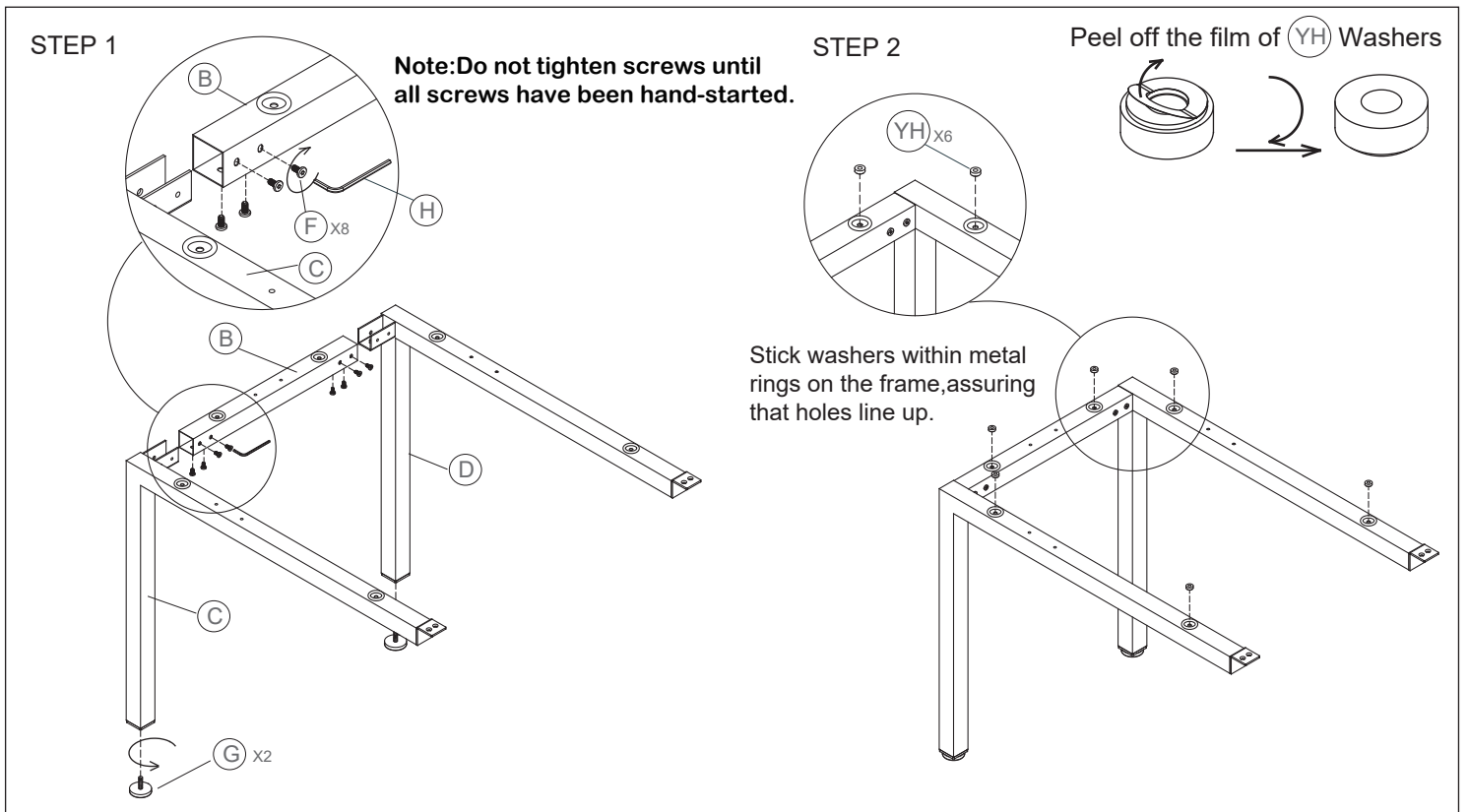



At Work- Return for 72" L Desk

Assembly Instructions

INSTRUCTIONS

STEP 3

Return at right

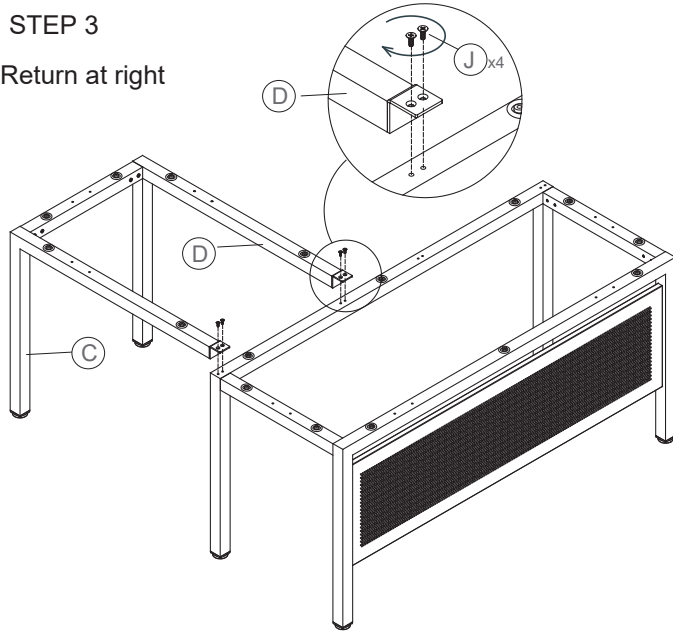

Return at left

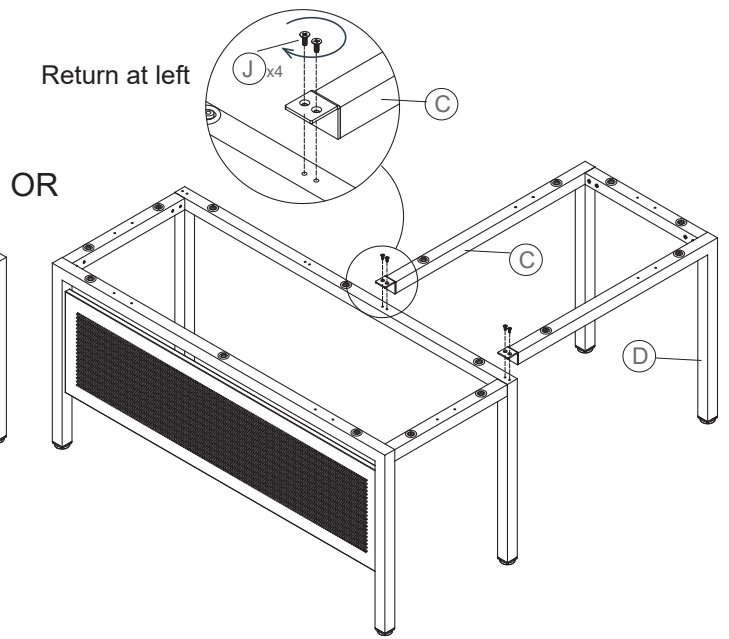

STEP 4

Return at right

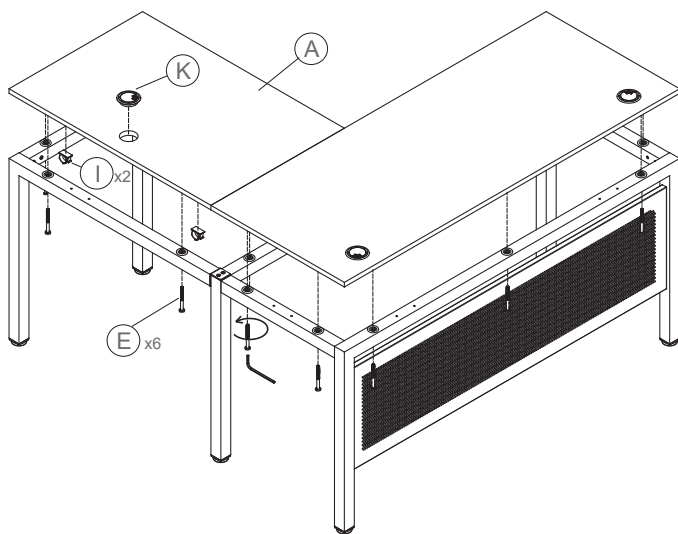

Return at left

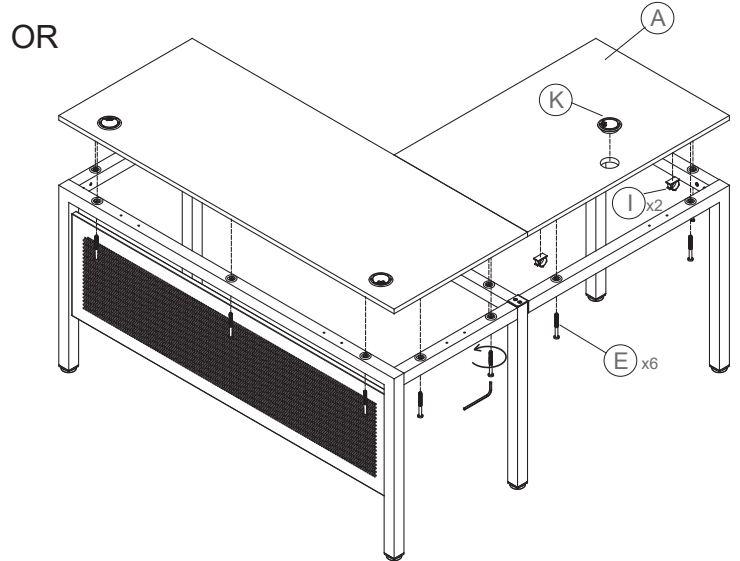



At Work- Return for 72" L Desk

Assembly Instructions

INSTRUCTIONS

Return at right

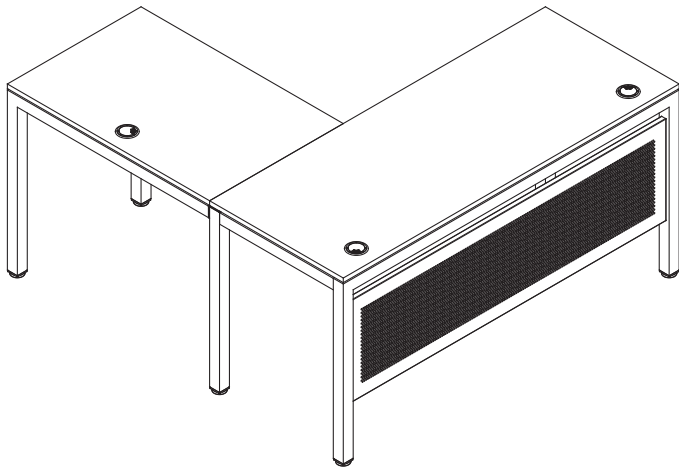

Return at left

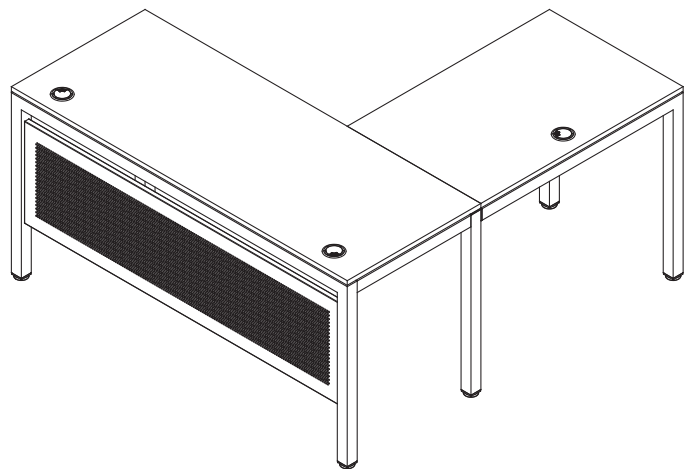

COMPLETED