

# Assembly Guide

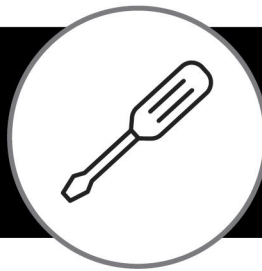

If you're having any difficulty during assembly of this product, don't hesitate to call us at **1-800-950-4782.**

Our customer service experts are trained to provide step-by-step instruction and can easily replace any missing or damaged parts.

**Representatives are available Monday-Friday from 8:30 a.m. to 7:30 p.m. (ET)**

## 72 x 30 Desk

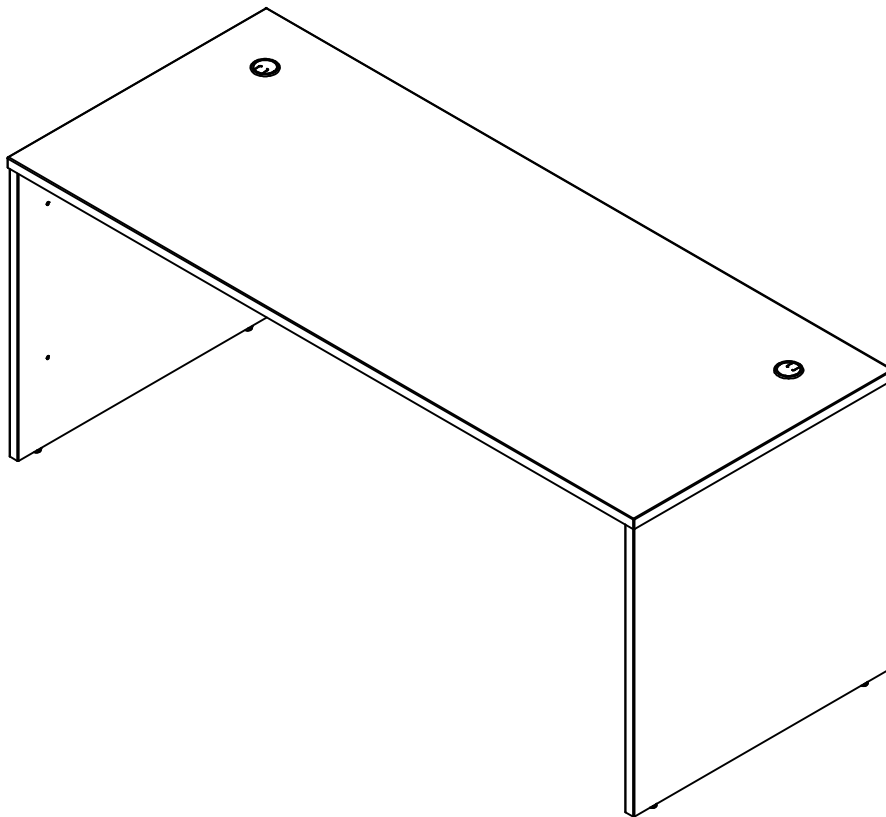

Lot Code #

Instruction Sheet Number A177075H

Keep manual for future reference.

## For best results, keep these tips in mind:

- ① We know you want to finish this assembly as quickly as possible, but trust us: you'll have a better experience if you take it one step at a time.
- ② Give yourself some room to work near where you want the fully assembled product.
- ③ If your floor isn't carpeted, assemble this product on the empty carton to avoid scratching.
- ④ Do you have a friend who owes you a favor? Some steps may go a little easier with a second set of hands.

### DOs

- ✔ Use a #2 Phillips head screwdriver (or other handheld tools as indicated)
- ✔ Wear safety glasses at all times during assembly
- ✔ Carefully follow the instructions in this guide and complete all steps in order
- ✔ Give us a call if you're having trouble with a particularly tricky step

### DON'Ts

- ✘ We know power tools are quick and easy, but you shouldn't use them when assembling this product (unless otherwise specified)
- ✘ Never move your furniture with items inside or resting on the surface
- ✘ Do not attempt to use this product before all steps have been completed



## Watch assembly videos right on your phone or computer!



Some steps include QR codes that link to helpful videos. Watch out for the icon below! Simply open up your smartphone camera to scan the code.

*(Users of older smartphones may need to install a QR Reader.)*

**SCAN HERE**



**FOR VIDEOS**

Or visit <https://www.bushbusinessfurniture.com/CustomerService/HowtoAssemble.aspx>

# IMPORTANT SAFETY INFORMATION



## PLEASE READ WARNINGS

Improper use can cause safety hazards, or damage to your furniture and household items.

Warning	Do	Don't	Why it's important
<b>Serious injury may occur.</b>	<ul style="list-style-type: none"><li>Assemble following all instructions using all indicated parts and hardware provided.</li></ul>	<ul style="list-style-type: none"><li>Do not move unit when loaded.</li><li>Do not load with a television or other heavy equipment.</li><li>Do not exceed the maximum load limits stated in the instructions.</li></ul>	Improper assembly, use or loading can lead to product instability, tipover, or collapse.

Advertencia	Hacer	No	Por qué es importante
<b>Pueden producirse lesiones graves.</b>	<ul style="list-style-type: none"><li>Realice el montaje siguiendo todas las instrucciones y utilizando todas las piezas indicadas y los herrajes suministrados.</li></ul>	<ul style="list-style-type: none"><li>No mueva la unidad cuando esté cargada.</li><li>No cargue el mueble con un televisor u otro equipo pesado.</li><li>No supere los límites máximos de carga indicados en las instrucciones.</li></ul>	El montaje, uso o carga inadecuados pueden provocar inestabilidad, vuelco o colapso del producto.

Avertissement	À faire	À ne pas faire	Pourquoi c'est important
<b>Peut entraîner des blessures graves.</b>	<ul style="list-style-type: none"><li>Assembler en suivant toutes les instructions et en utilisant toutes les pièces et la quincaillerie incluses.</li></ul>	<ul style="list-style-type: none"><li>Ne pas déplacer le meuble lorsqu'il est chargé.</li><li>Ne pas charger le meuble avec un téléviseur ou tout autre équipement lourd.</li><li>Ne pas dépasser les limites de poids maximales indiquées dans les instructions.</li></ul>	Un assemblage, une utilisation ou un chargement incorrects peuvent entraîner l'instabilité, le basculement ou l'effondrement du produit.

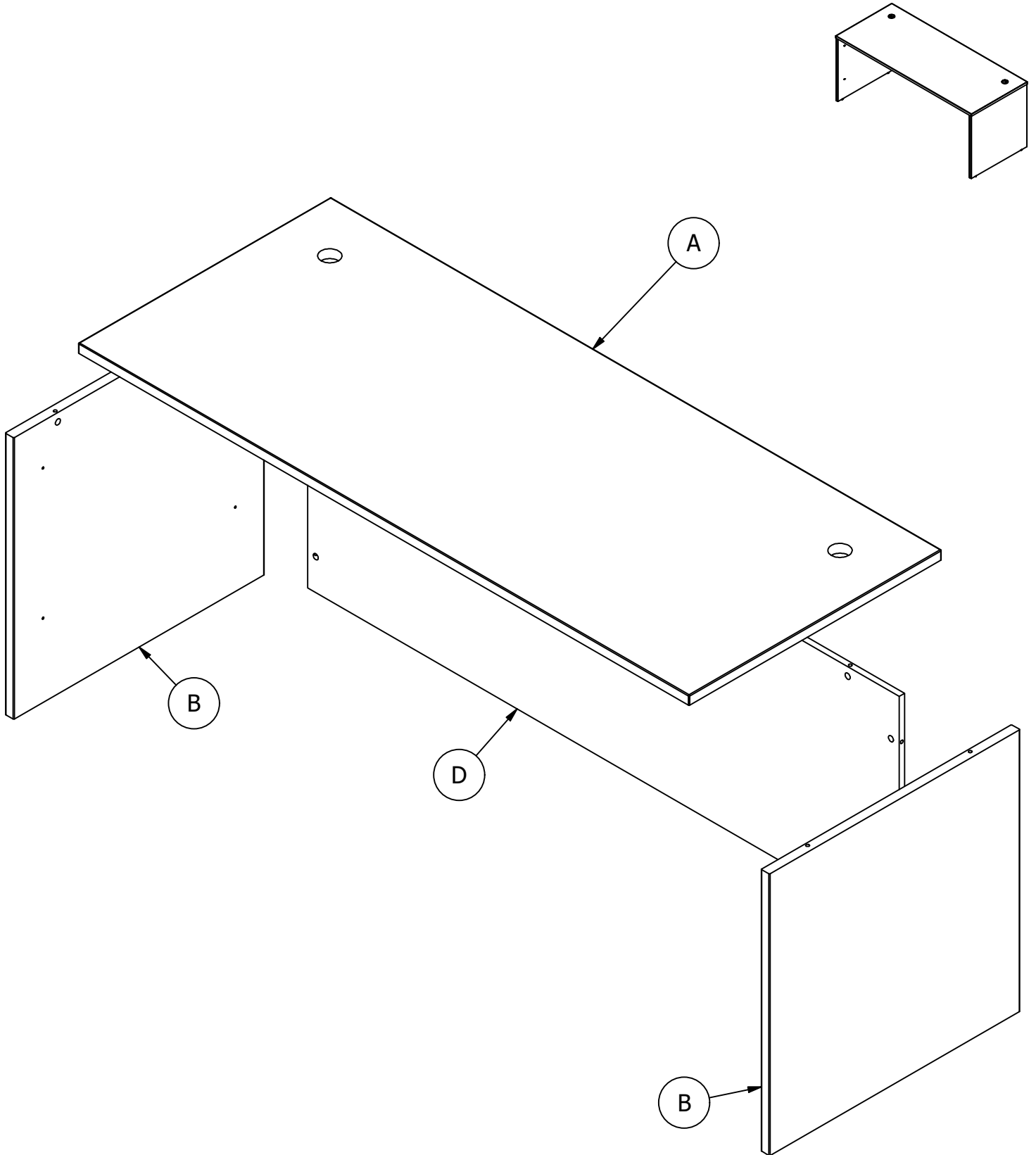

Have an assembly question or need a replacement part? Just call  
**1-800-950-4782**, we are here to help.

Fasteners are shown actual size.

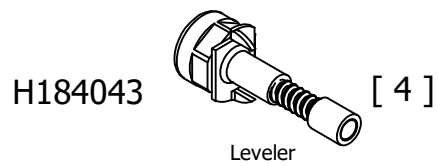
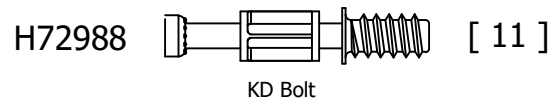
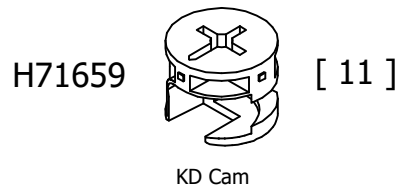
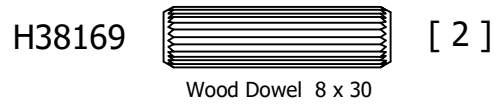

Have an assembly question or need a replacement part? Just call  
**1-800-950-4782**, we are here to help.

Hardware not to scale.

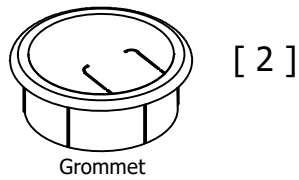
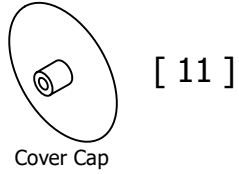

Have an assembly question or need a replacement part? Just call  
**1-800-950-4782**, we are here to help.

# STEP 1

## Prepare Panel

A177075H

H72988

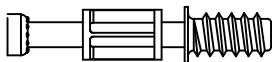

[ 2 ]

KD Bolt



[ 2 ]

5mm Hole Plug

H184043

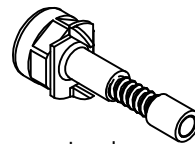

[ 2 ]

Leveler

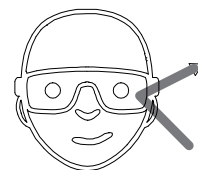
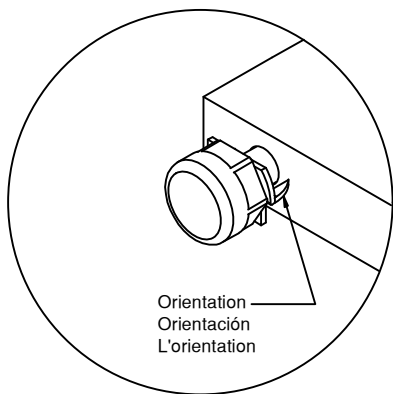
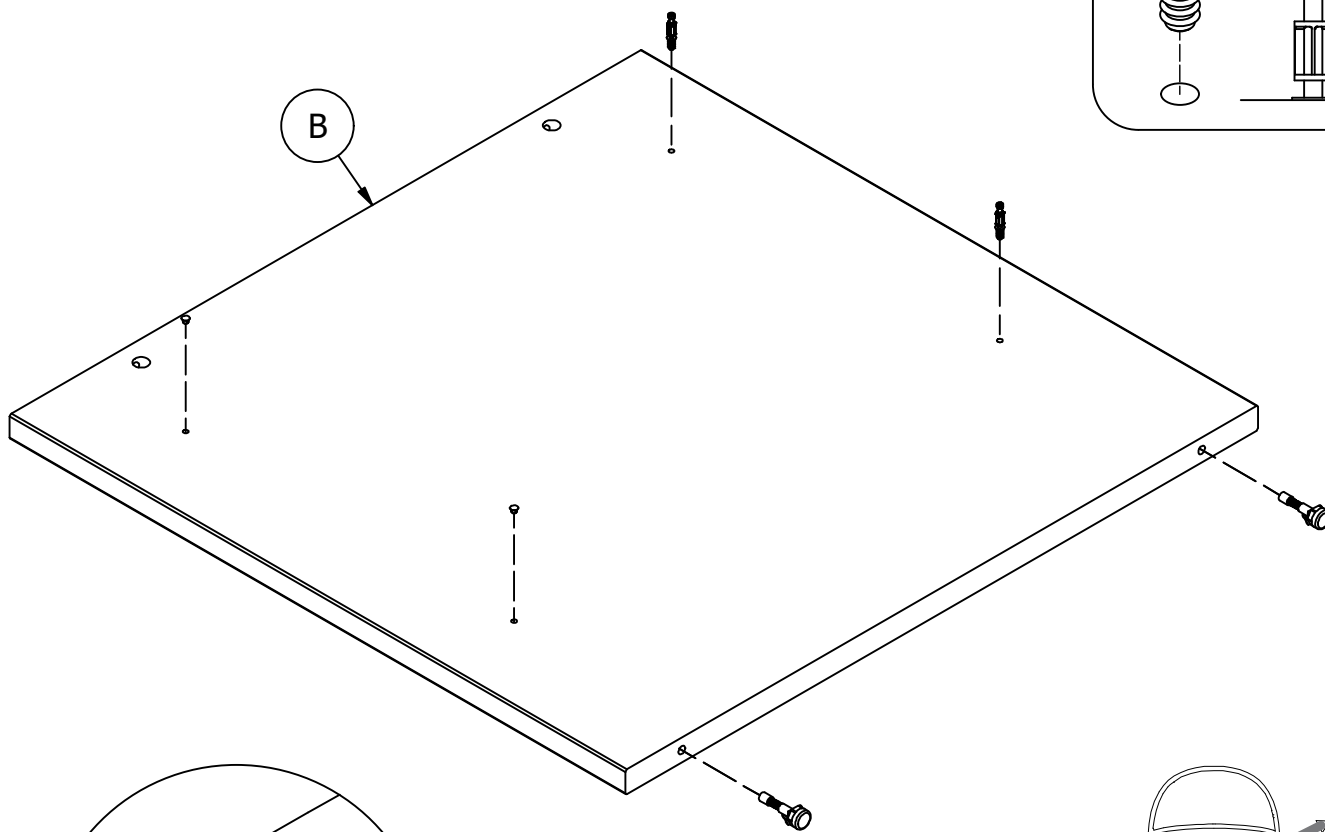
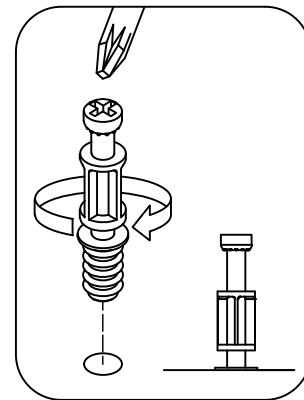

Safety glasses  
Gafas de seguridad  
Lunettes de protection

Have an assembly question or need a replacement part? Just call  
**1-800-950-4782**, we are here to help.

# STEP 2

# Prepare Panel

A177075H

H72988 [ 2 ]  
KD Bolt

[ 2 ]  
5mm Hole Plug

H184043 [ 2 ]  
Leveler

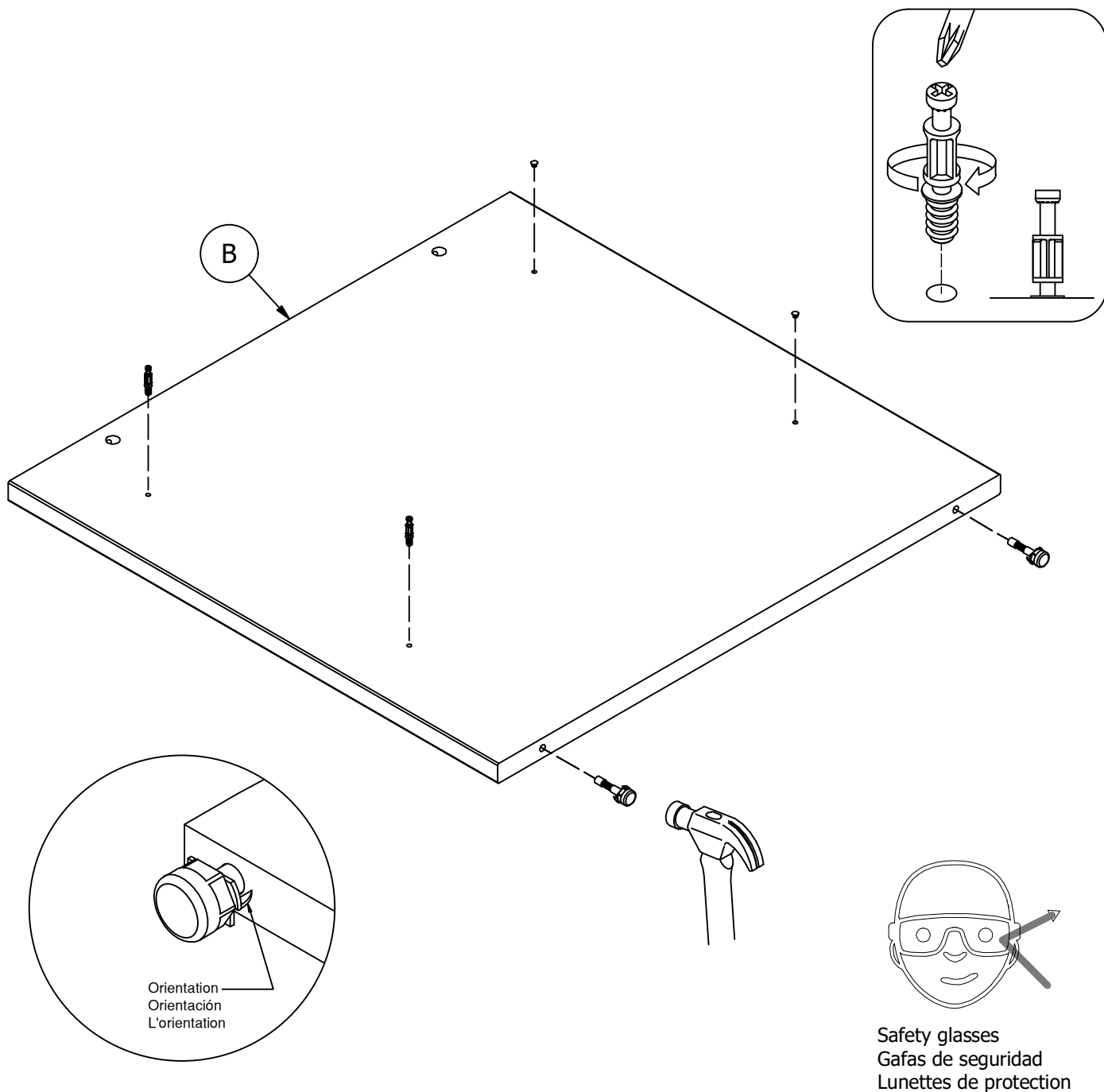

Have an assembly question or need a replacement part? Just call  
**1-800-950-4782**, we are here to help.



# STEP 3

# Assemble Panels

A177075H

Scan QR Code to Watch Video on:



How to Tighten KD Cams

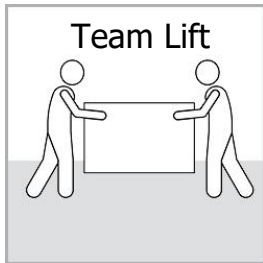

H71659

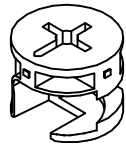

KD Cam

[ 2 ]

H38169

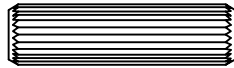

Wood Dowel 8 x 30

[ 2 ]



Cover Cap

[ 2 ]

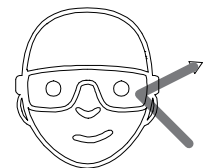
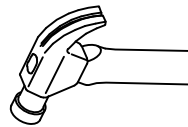
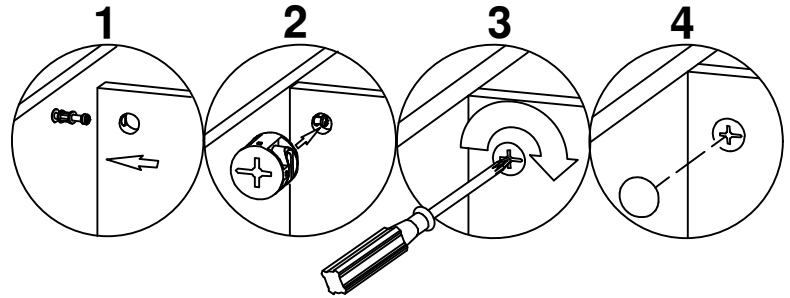

Safety glasses  
Gafas de seguridad  
Lunettes de protection

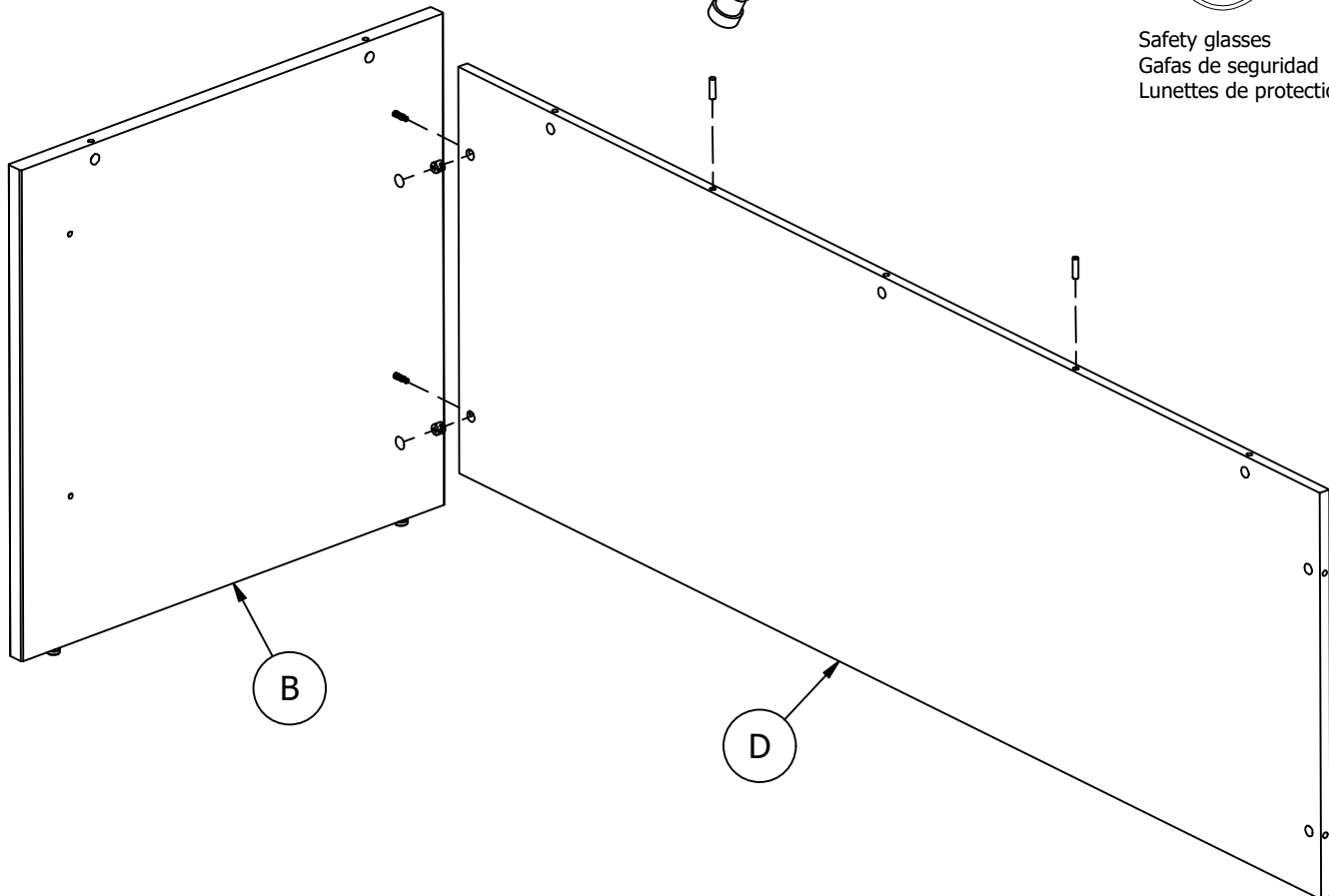

Have an assembly question or need a replacement part? Just call **1-800-950-4782**, we are here to help.

# STEP 4

## Assemble Panels

A177075H

Scan QR Code to Watch Video on:



How to Tighten KD Cams

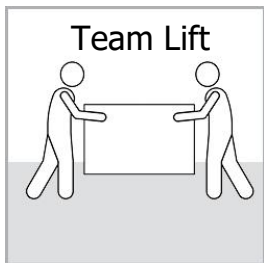

H71659

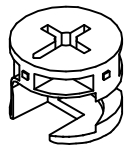

KD Cam

[ 2 ]

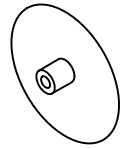

Cover Cap

[ 2 ]

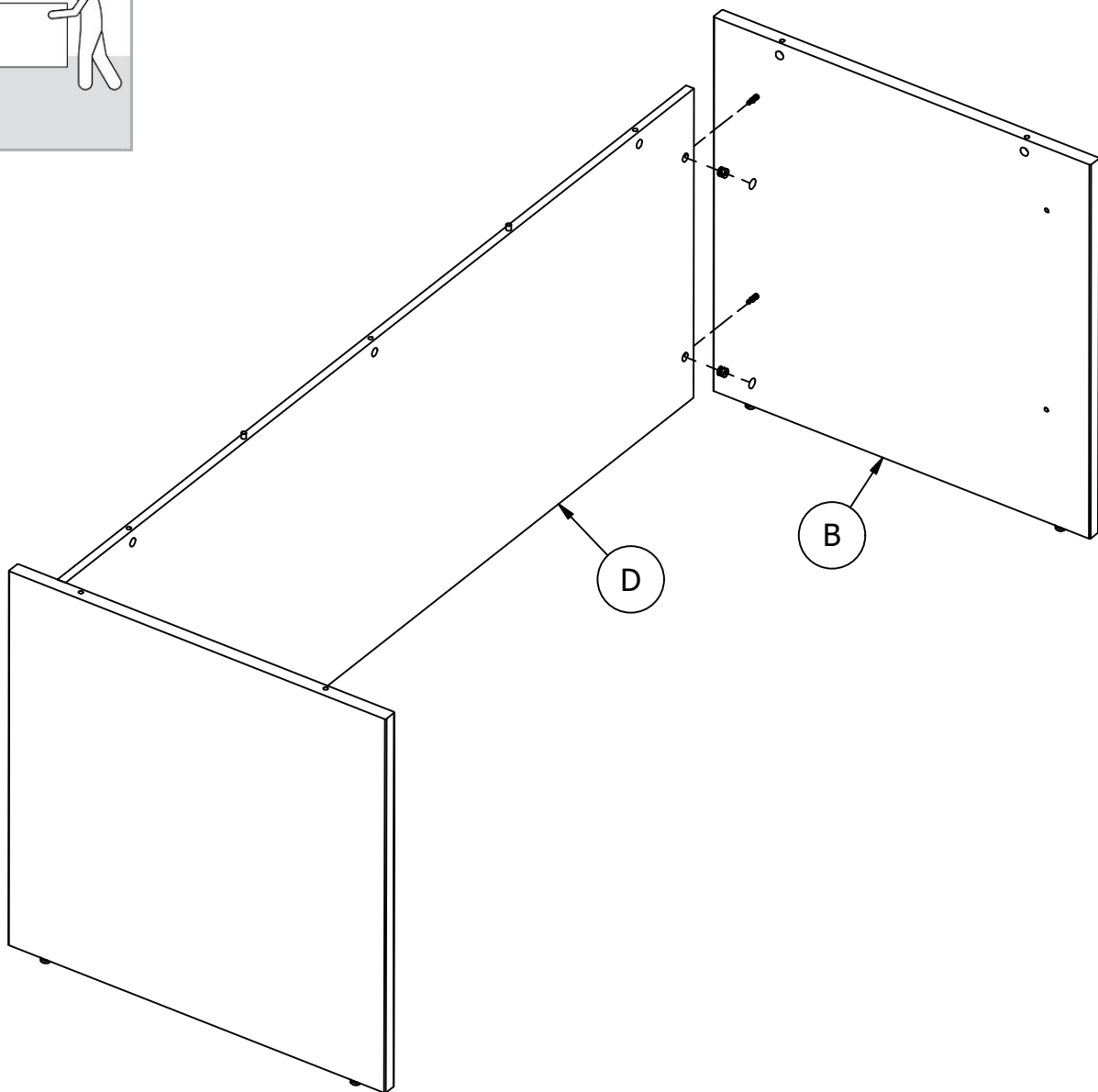
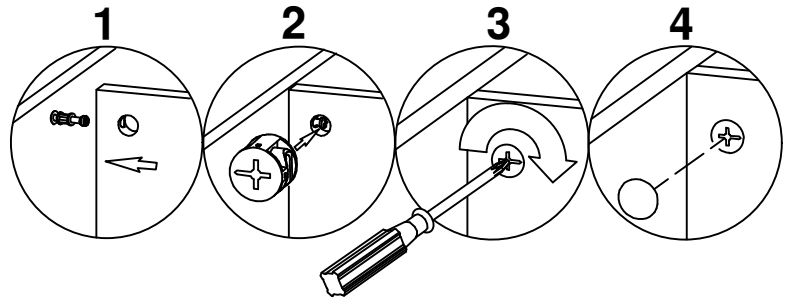

Have an assembly question or need a replacement part? Just call **1-800-950-4782**, we are here to help.

# STEP 5

# Prepare Panel

A177075H

H72988  [ 7 ]  
KD Bolt

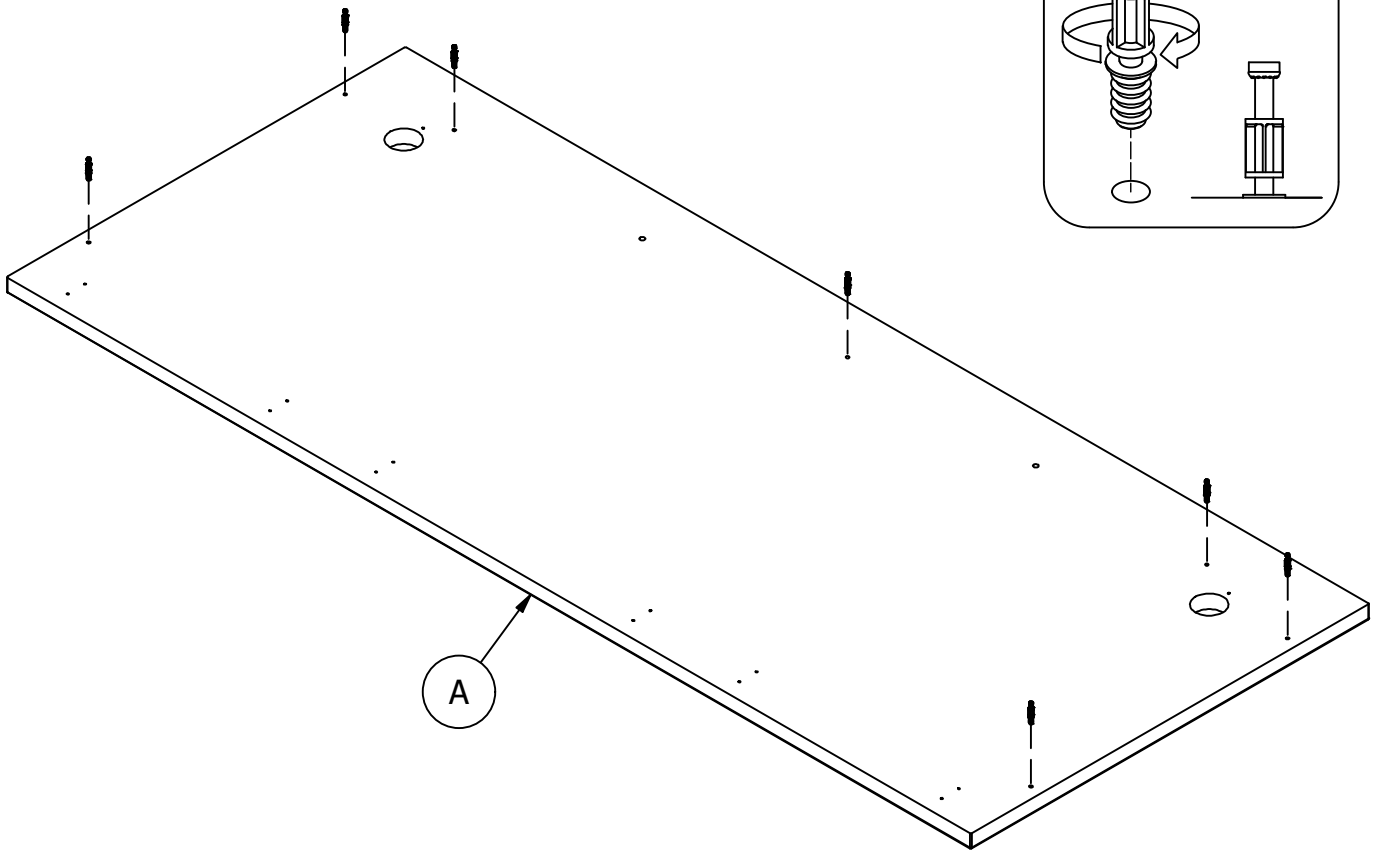
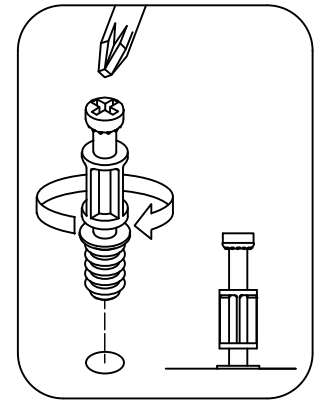

Have an assembly question or need a replacement part? Just call  
**1-800-950-4782**, we are here to help.

# STEP 6

# Assemble Panels

A177075H

Scan QR Code to Watch Video on:



How to Tighten KD Cams

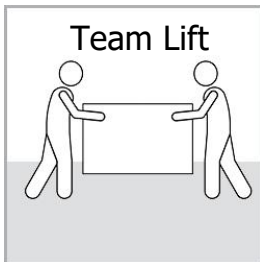

H71659

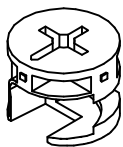

KD Cam

[ 7 ]

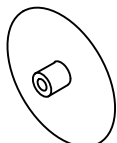
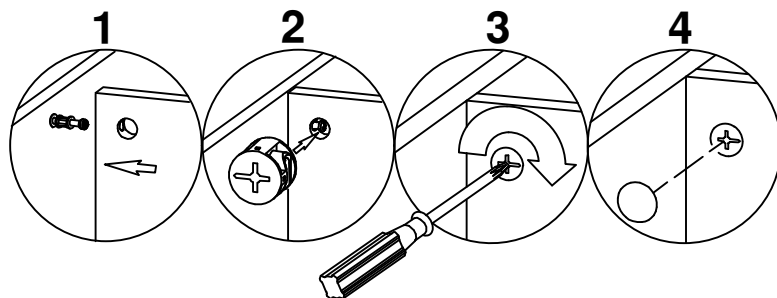

Cover Cap

[ 7 ]

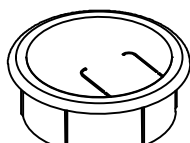

Grommet

[ 2 ]

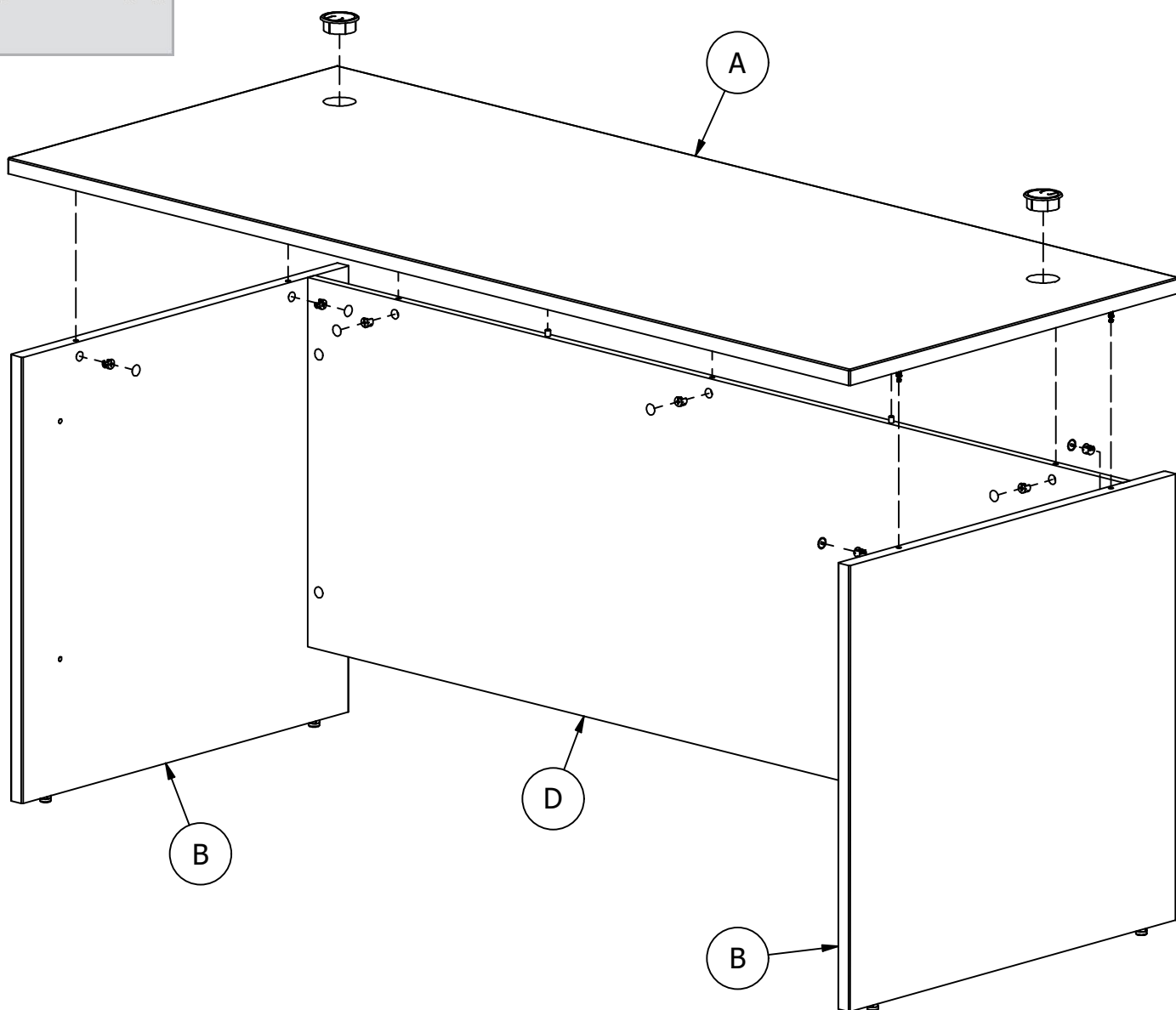

Have an assembly question or need a replacement part? Just call **1-800-950-4782**, we are here to help.

Scan QR Code to  
Watch Video on:



How to Clean  
the Surface

Gently clean surfaces with  
a damp sponge eraser.

Maximum Weight: 200 Lbs.  
Peso Máximo: 200 Libras  
Poids Maximum: 90.7 kilogramme

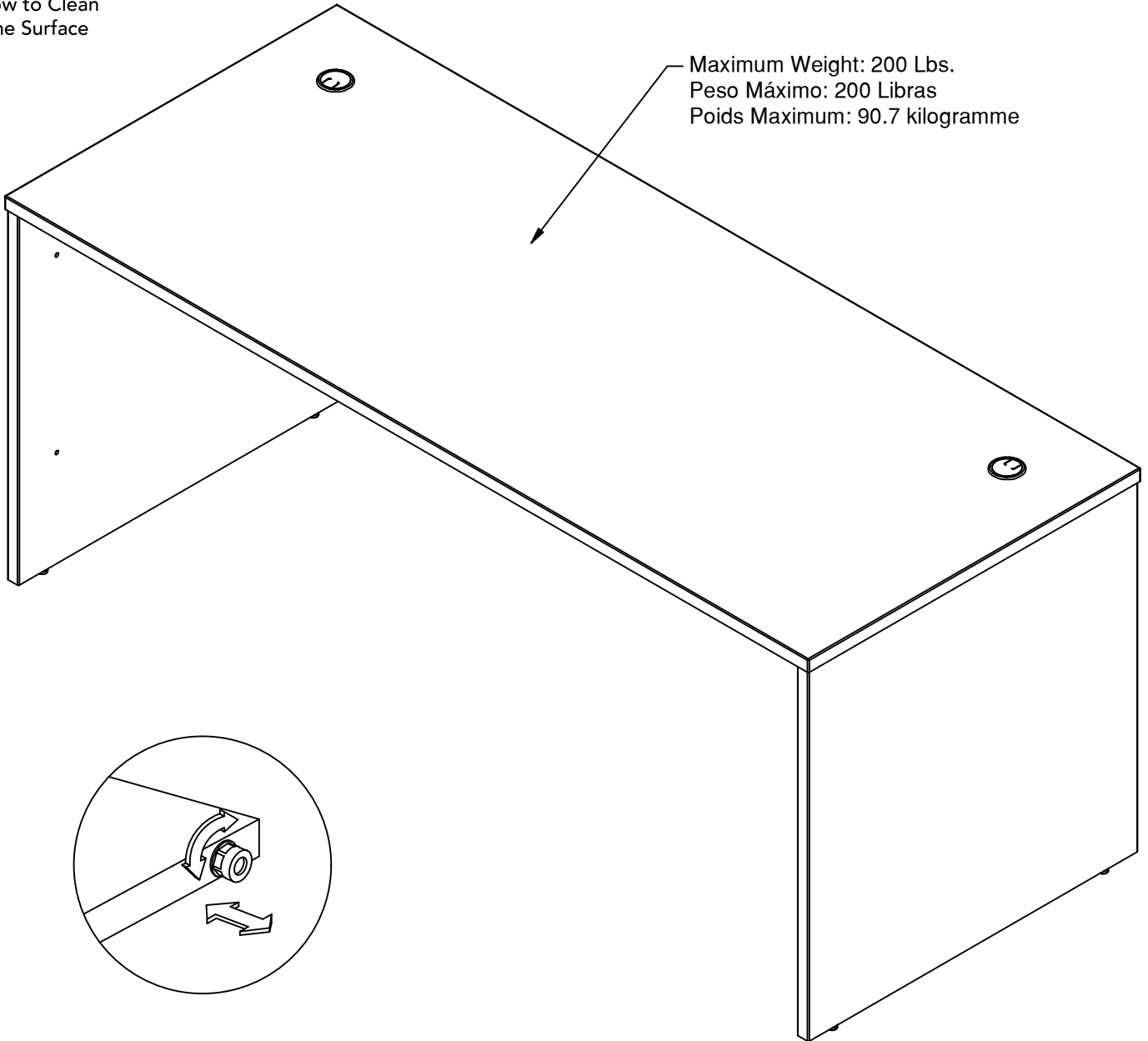

Congratulations! You are all done. If you  
have any questions or concerns, please call.

Have an assembly question or need a replacement part? Just call  
**1-800-950-4782**, we are here to help.

### WC12936

- A [ 1 ] W206129
- B [ 2 ] W206134
- D [ 1 ] W177064

H73621 [ 11 ]

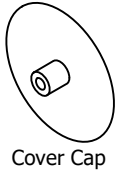

Cover Cap

H63904 [ 4 ]



5mm Hole Plug

H118700 [ 2 ]

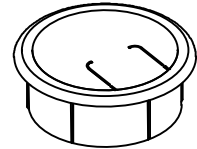

Grommet

### WC24436

- A [ 1 ] W206124
- B [ 2 ] W206135
- D [ 1 ] W177066

H92521 [ 11 ]

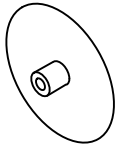

Cover Cap

H92523 [ 4 ]



5mm Hole Plug

H118700 [ 2 ]

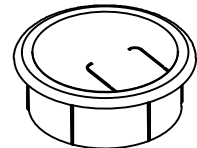

Grommet

### WC36736

- A [ 1 ] W206131
- B [ 2 ] W206136
- D [ 1 ] W177068

H107306 [ 11 ]

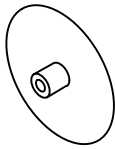

Cover Cap

H107309 [ 4 ]



5mm Hole Plug

H118700 [ 2 ]

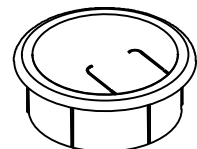

Grommet

### WC72436

- A [ 1 ] W206133
- B [ 2 ] W206135
- D [ 1 ] W177066

H92521 [ 11 ]

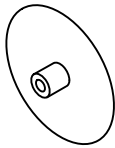

Cover Cap

H92523 [ 4 ]



5mm Hole Plug

H118700 [ 2 ]

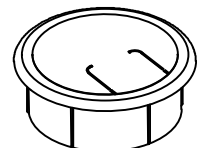

Grommet

Have an assembly question or need a replacement part? Just call  
**1-800-950-4782**, we are here to help.

### SCD272HC

- A [ 1 ] W206124
- B [ 2 ] W206139
- D [ 1 ] W176084

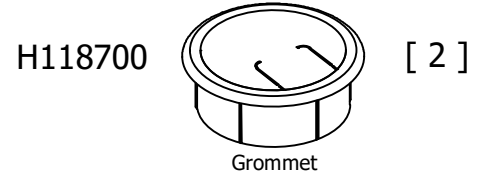
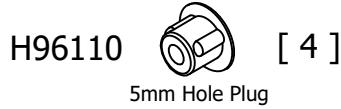
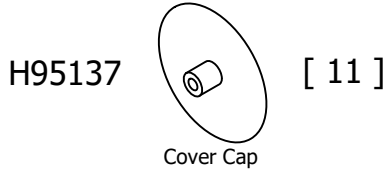

### SCD272WH

- A [ 1 ] W206128
- B [ 2 ] W206143
- D [ 1 ] W191873

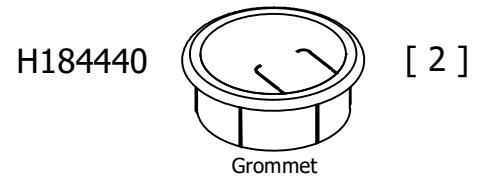
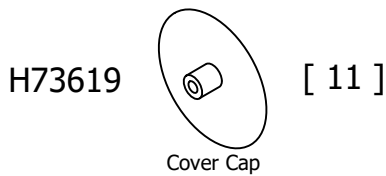

### SCD272SG

- A [ 1 ] W206126
- B [ 2 ] W206141
- D [ 1 ] W189320

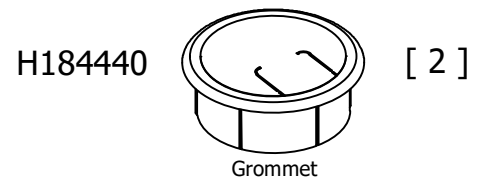
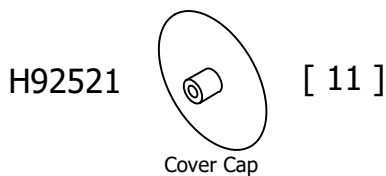

### SCD272HC

- A [ 1 ] W206124
- B [ 2 ] W206139
- D [ 1 ] W176084

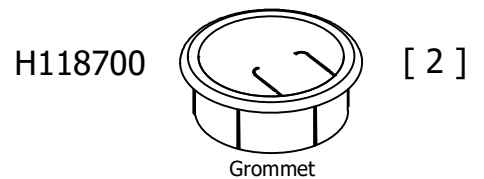
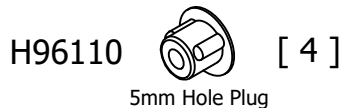
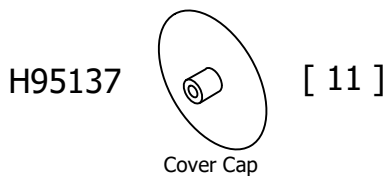

Have an assembly question or need a replacement part? Just call  
**1-800-950-4782**, we are here to help.

### SCD272BW

- A [ 1 ] W205518
- B [ 2 ] W205519
- D [ 1 ] W191812

H191633

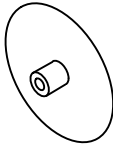

[ 11 ]

Cover Cap

H63904



[ 4 ]

5mm Hole Plug

H118700

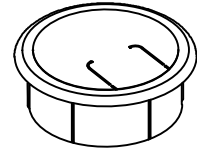

[ 2 ]

Grommet

### SCD272MH

- A [ 1 ] W205520
- B [ 2 ] W205521
- D [ 1 ] W193108

H83021

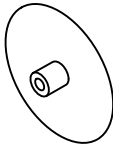

[ 11 ]

Cover Cap

H112099



[ 4 ]

5mm Hole Plug

H151406

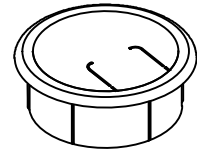

[ 2 ]

Grommet

### SCD272NE

- A [ 1 ] W216001
- B [ 2 ] W215994
- D [ 1 ] W215998

H216046

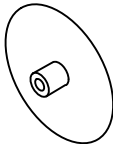

[ 11 ]

Cover Cap

H216047



[ 4 ]

5mm Hole Plug

H216048

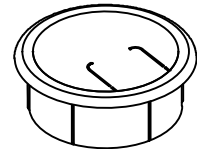

[ 2 ]

Grommet

### SCD272PG

- A [ 1 ] W206125
- B [ 2 ] W206140
- D [ 1 ] W191639

H83021

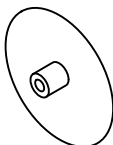

[ 11 ]

Cover Cap

H112099



[ 4 ]

5mm Hole Plug

H151407

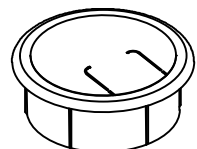

[ 2 ]

Grommet