

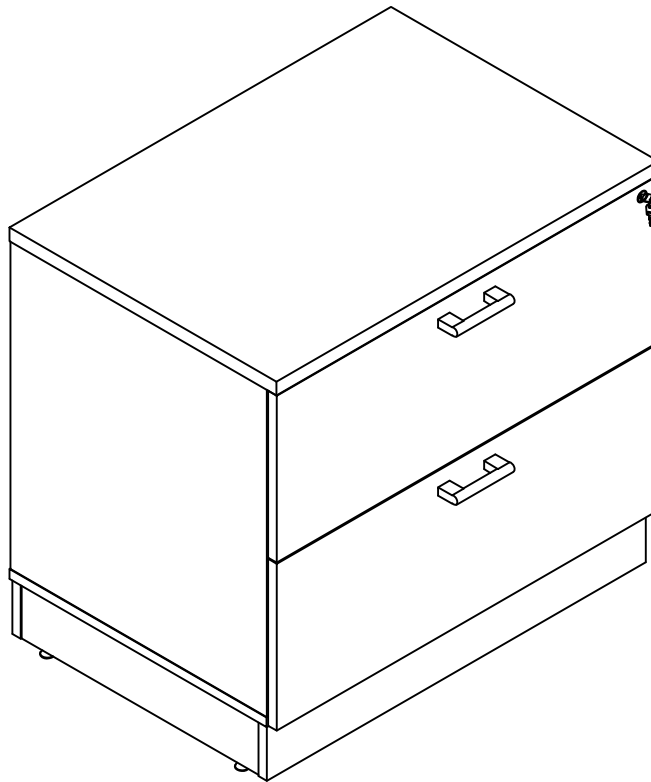





National Business
Furniture

Esquire Collection -Lateral File
ASSEMBLY INSTRUCTIONS



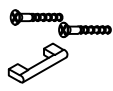

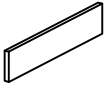
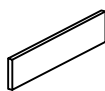
Assembly HARDWARE				
S/N	PICTURE	NAME	TOTAL QTY	REMARK
A		leveler	4PCS	
B		Handle With Screws	2SET	Pre-installed inside
C		File clip	12+1(SPARE)	
D		Aluminum File Bar (Long)	2PCS	Use for side to side filing
E		Aluminum File Bar (short)	4PCS	Use for front to back filing

1. INSTALL THE "A" LEVELERS ON THE BOTTOM OF BASE SUPPORT .
A(4x)

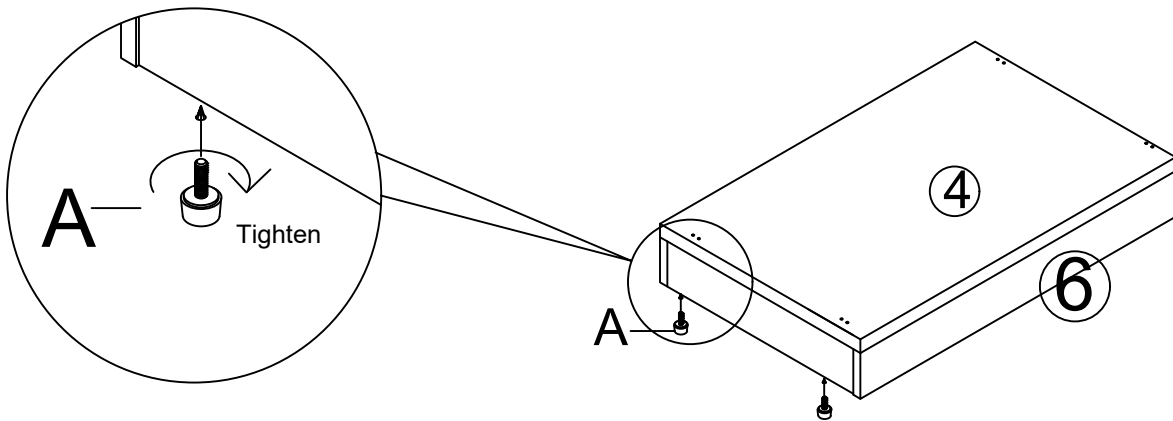



2. INSTALL "B" HANDLES ON DRAWERS, ONE PER DRAWER. PLACE FILE BARS INSIDE DRAWERS WITH "C" FILE CLIPS , USE 2 WITH EACH BAR.

- B(2x)
- C(12X)
- D (2X)
- E(4X)

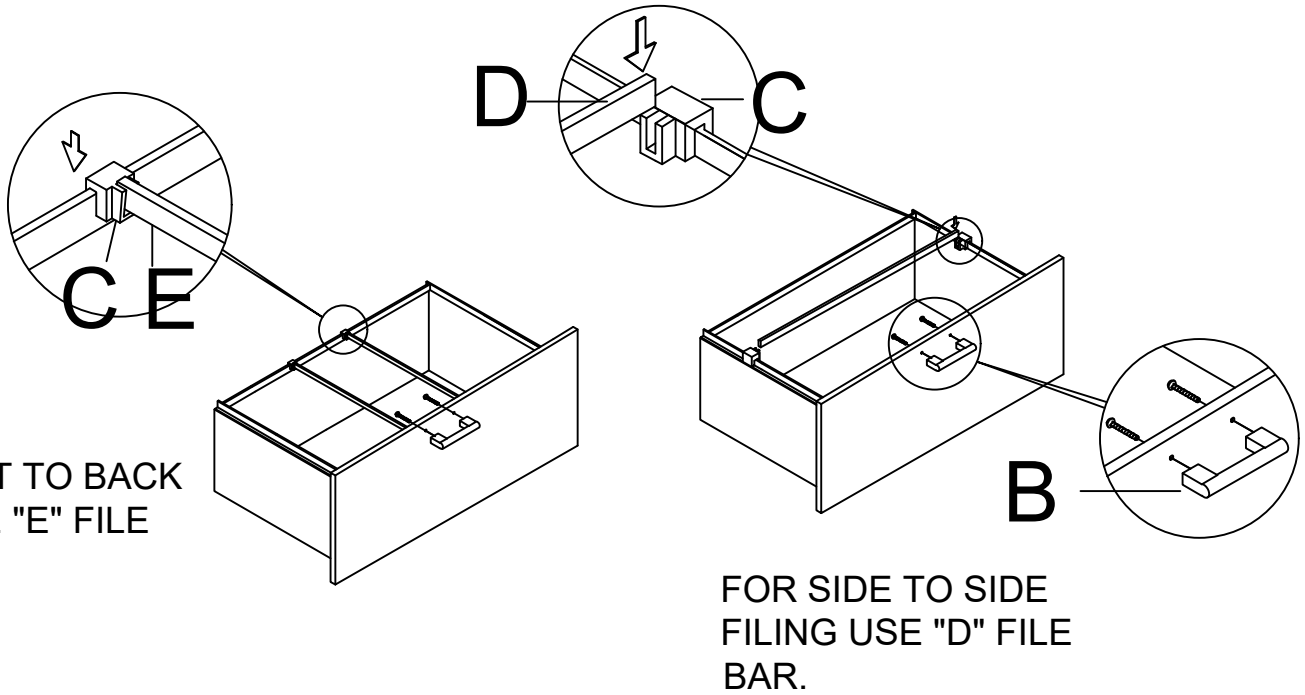

3. COMPLETE

