

2

1

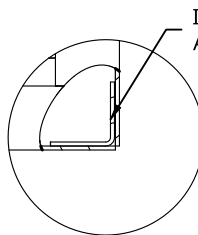
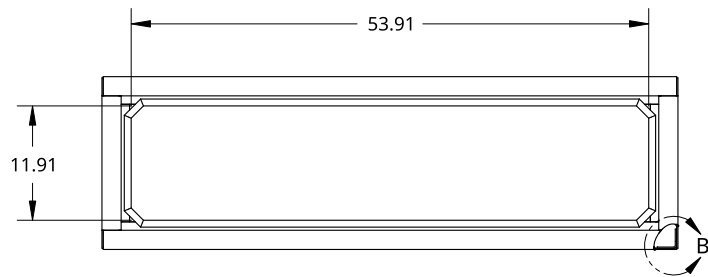

DETAIL B
SCALE 1:6

INNER REINFORCEMENT
ANGLE BOTH SIDES

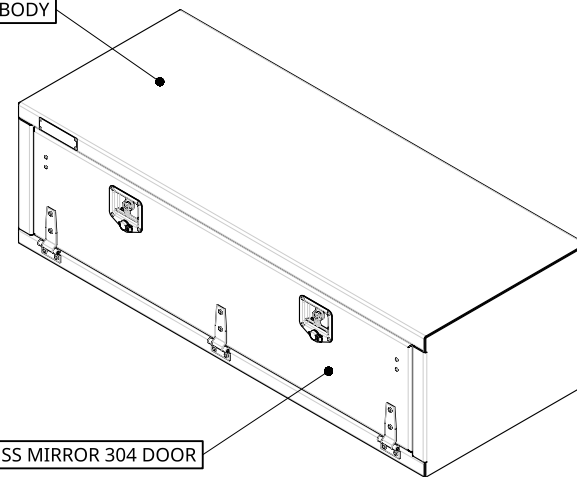

2 1/8 ALU MILL BODY

1 18G SS MIRROR 304 DOOR

X2 DOOR CHAIN TO HOLD
DOOR AT 90 DEG.

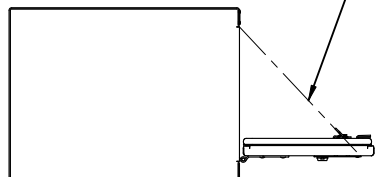

SMALL SIZE TREBOR NAME PLATE

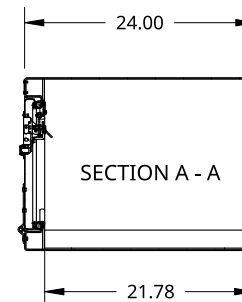
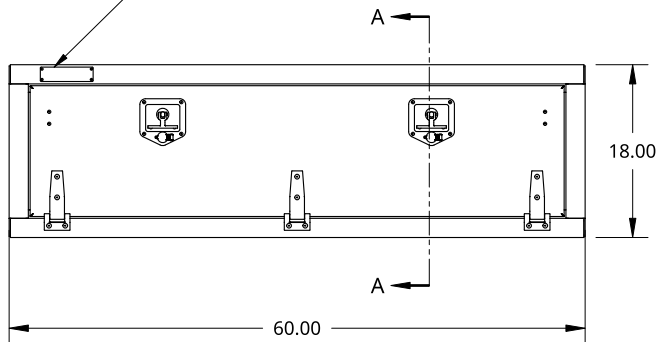

SECTION A - A

B

B

A

A

2

1

THIS DOCUMENT IS THE PROPERTY OF TREBOR
MANUFACTURING. ANY UNAUTHORIZED REPRODUCTION
WILL BE PROSECUTED TO THE FULL EXTENT OF THE LAW

UNLESS OTHERWISE SPECIFIED,
DIMENSIONS ARE IN INCHES

.XX = ±.1-
.XXX = ±.015- ANGULAR = ±1°
.XXXX = ±.005- FRACTIONAL = ±1/8

THIRD ANGLE PROJECTION

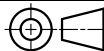

DRAWN BY	SHAWN CROCKER	08/03/2021
CHANGED BY	RAUL MANRIQUE	12/16/2022

MATERIAL
1/8 ALU MILL BODY, 18G S/S
MIRROR DOOR

PART NO. TRIDPLSS1860 REV. B

ONE DOOR RECESSED DOOR TOOL BOX - 24 X 18 X 60 - 18G SS MIRROR
DOOR - X2 T-HANDLES - X3 HINGES - OPEN DOWN

SIZE A DWG NO. D9603 REV. B

SCALE 1:20	WEIGHT 84.3 LB	SHEET 1 of 1
------------	----------------	--------------