



**GENERAL MONITORS**  
*Protection for life.*

# MODEL ZN002A

Zero Two Series  
Zone Control Module



The information and technical data disclosed in this document may be used and disseminated only for the purposes and to the extent specifically authorized in writing by General Monitors.

## **INSTRUCTION MANUAL 01/96**

General Monitors reserves the right to change published specifications and designs without prior notice.

Part No.  
Revision

MANZN002A  
B/01-96



B/01-96

## Warranty

General Monitors warrants the Model ZN002A Zone Control Module to be free from defects in workmanship or material under normal use and service within two years from the date of shipment. General Monitors will repair or replace without charge any equipment found to be defective during the warranty period. Full determination of the nature of, and responsibility for defective or damaged equipment will be made by General Monitors' personnel. Defective or damaged equipment must be shipped to General Monitors' plant or the representative from which the original shipment was made. In all cases this warranty is limited to the cost of the equipment supplied by General Monitors. The customer will assume all liability for the misuse of this equipment by its employees or other personnel. All warranties are contingent upon proper use in the application for which the product was intended and do not cover products which have been modified or repaired without General Monitors' approval or which have been subjected to neglect, accident, improper installation or application, or on which the original identification marks have been removed or altered. Except for the express warranty stated above, General Monitors disclaims all warranties with regard to the products sold, including all implied warranties of merchantability and fitness and the express warranties stated herein are in lieu of all obligations or liabilities on the part of General Monitors for damages including, but not limited to, consequential damages arising out of/or in connection with the performance of the product.

## Warnings

- TOXIC, COMBUSTIBLE AND FLAMMABLE GASES & VAPORS ARE VERY DANGEROUS. EXTREME CAUTION SHOULD BE USED WHEN THESE HAZARDS ARE PRESENT.
- All Zero Two Series Modules contain components which can be damaged by static electricity. Special care must be taken when wiring the system to ensure that only the connection points are touched.
- Only sensors and field devices approved by General Monitors will work with associated Zero Two Series Gas & Flame Detection Modules. Any attempt to use a sensor or device that has not been approved by General Monitors will void the Warranty.
- **SAFETY WARNING:** **Installation and Maintenance must be carried out by suitably skilled and competent personnel only.**



	<u>Page Number</u>
Warranty .....	i
Warnings .....	i
<b>1 Introduction</b>	
1.1 System Description .....	1
1.2 Model ZN002A Description .....	2
1.3 Features & Benefits .....	3
<b>2 Specifications</b>	
2.1 System Specifications .....	5
2.2 Mechanical Specifications .....	5
2.3 Electrical Specifications .....	5
2.4 Environmental Specifications .....	5
2.5 Engineering Specifications .....	6
<b>3 Installation</b>	
3.1 Upon Receipt of Equipment .....	7
3.2 Chassis Installation .....	7
3.3 Module Installation .....	7
3.4 Terminal Connections .....	8
3.5 Applying Power .....	9
<b>4 Operation</b>	
4.1 General Maintenance .....	11
4.2 Electrical Inputs .....	11
4.3 Electrical Outputs .....	12
4.4 Accepting Alarm Conditions .....	12
4.5 Resetting Latched Alarms .....	13
4.6 User Selectable Options .....	13
<b>5 Appendix</b>	
Appendix A Glossary of Terms .....	15
Appendix B Engineering Documentation .....	17
Appendix C Ordering Information .....	24
Appendix D Zero Two Series Modules .....	25
<b>6 Index</b> .....	27



		<u>Page Number</u>
Figure 1	Model ZN002A, 3/4 View .....	1
Figure 2	Coding Strip Diagram .....	7
Figure 3	Wire Strip Length Diagram .....	8
Figure 4	Rear Terminal Designations .....	8
Figure 5	Typical External Circuit for Open Collectors .....	9
Figure 6	Primary Input Power (+24Vdc) Location .....	9
Figure 7	Schematic Diagram - Display Board .....	17
Figure 8	Schematic Diagram - Control Board .....	18 & 19
Figure 9	Circuit Card Assembly - Display Board .....	20
Figure 10	Circuit Card Assembly - Control Board .....	21
Figure 11	Outline & Dimensional Drawing - Model ZN002A .....	22
Figure 12	Final Assembly Drawing .....	23



*The Introduction provides a description of the Zero Two System, the Model ZN002A and the features & benefits.*

### 1.1 System Description

The Zero Two Series Modules have been developed for the purpose of creating combined fire and gas detection systems. There is a module for flame detection and each type of gas detection that General Monitors offers.

<u>Module</u>	<u>Type of field device</u>
4802A	Combustible Gas Sensors
2602A	Hydrogen Sulfide (H <sub>2</sub> S) Gas Sensors
TA102A	Combustible Gas Smart Sensors
TA202A	H <sub>2</sub> S Gas Smart Sensors
TA402A	FL3000 Family of Flame Detectors

In addition to the Fire and Gas Detection Modules there are Accessory Modules that perform system functions (e.g. alarm reset, alarm accept) and will enhance the performance of the system (e.g. extra relay capacity, zoning and voting).

<u>Module</u>	<u>Description</u>
FM002A	Facilities Module
IN042	Four Zone Input Module
MD002	Monitored Driver Module
*PS002*	Power Supply Module
RL002	Relay Module
ZN002A	Zone Control Module

\* = The Model PS002 is designed for Non-European Countries

The Zero Two Series modules reside in a 4, 8, or 16 channel chassis that can be rack or panel mounted. The back of each chassis provides a bus for the common and system signals that are sent to and from the Facilities Module (FM002A) and the Power Supply Module (PS002).

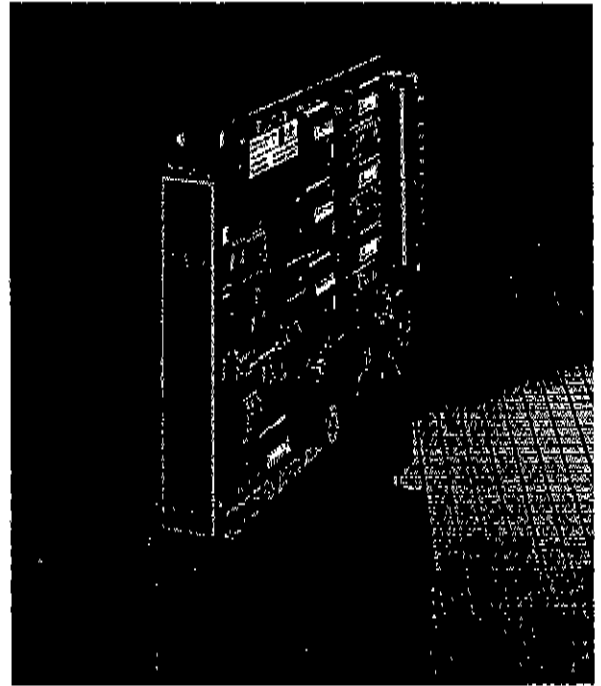

Figure 1

The bussed power connections are:

**+24 VDC** Positive Supply Voltage  
**Common** System Ground

Each module operates from a +24Vdc (nominal) input. This unregulated +24Vdc source is fed to an on board supply regulation circuit. The supply regulation circuit converts the unregulated +24Vdc input into the necessary supply voltages and currents for operating all of the circuitry on the module and the detection device in the field.

The Power Supply Module, Model PS002 (for use in Non-European Countries), or a customer supplied power supply, provides the bus with the +24Vdc for the modules.

**A1** Alarm Level 1  
**A2** Alarm Level 2

There are two separate alarm levels labeled "A1" and "A2". The "A2" alarm level is the most severe condition. These signals are sent to the Facilities Module.



B/01-96

## System Description *(continued)*

### Fault Malfunction

The "Fault" line signals the Facilities Module any time any of the modules in the system enters into a malfunction condition.

### Accept Alarm Accept

Alarm levels are accepted and the UA outputs (see below) are de-activated when the "ACCEPT" button on the front panel of the Facilities Module is depressed. This signal is sent to all of the modules on the bus by the Facilities Module.

### UA Unaccept / Acknowledge

The "UA" is activated anytime a new alarm level is activated. When an activated alarm level is accepted, the "UA" is de-activated. The "UA" will re-activate if another alarm level is activated.

### Reset Master Reset

Another button is provided on the front panel of the Facilities Module so that latched alarm levels can be "RESET". This signal is sent to all of the modules on the bus by the Facilities Module.

### CAL CAL Mode

Any time a module in the system is placed in the "CAL" mode a signal is sent on the bus to the Facilities Module.

## 1.2 Model ZN002A Description

The Zone Control Module (ZN002A) provides zoning and voting functions for three separate and independent zones of gas and/or flame detection. This module takes one channel in a Zero Two Series chassis.

The outputs from this Module include:

- One open collector output with a red front panel LED for each A1 and each A2 output. There is an A1 and an A2 output associated with each zone (*3 A1s & 3 A2s . . . . 6 total*)
- One open collector output for Fault indications with an amber front panel LED
- One green front panel LED for Ready indications

The open collector (OC) outputs from other modules are the inputs to the Model ZN002A. Up to eight (8) of these OC outputs from other modules may be grouped together (a zone) such that an output signal (A1) will occur when any single open collector of the group is active. A second output (A2) will occur if two or more open collectors of the same group are active. Each ZN002A consists of three such groups (zones).

When an alarm (A1 or A2) goes active, a front panel LED will flash until the ACCEPT button on the Facilities Module is pressed. The front panel LED will then change to a steady ON condition. When the alarm (A1 or A2) is reset, the front panel LED will turn OFF.



### **Model ZN002A Description** *(continued)*

During a fault condition the Fault LED on the front panel, will flash until the fault condition is accepted or corrected. If the fault is accepted, the Fault LED will stop flashing and stay ON until the fault is corrected. If the fault is corrected the Fault LED will turn OFF.

### **1.3 Features & Benefits**

The Model ZN002A provides the system with three independent zones for additional flexibility. The outputs from these zones can connect to interposing relays. Additionally, each Model ZN002A has the standard features listed below:

**Multiple Zones** - Three independent zones, monitoring up to 24 gas & flame detection modules can be achieved using a single Model ZN002A.

**Independent Voting** - Each zone has independent voting, 1 and 2 votes per zone.

**Microprocessor Based Electronics** - monitors fault conditions, inputs and provides outputs in the form of LEDs and open collector activations.

**Live Insertion/Removal** - allows the user to insert or remove a module while power is applied to the chassis without damage to any of the components in the system.

**Card Test** - this feature tests the input logic of every channel into each zone and is initiated by the operator.

**LED Test** - tests the integrity of each LED appearing on the front panel.



*Specifications are broken down into five areas. System specifications provide information not listed elsewhere. Mechanical specifications list out the physical dimensions. Electrical specifications itemize the general electrical ratings of certain component sections. Environmental specifications define the environmental limits of the unit. The Engineering specification provides the reader with a section of text that can be inserted into a quotation, another specification or document.*

## 2.1 System Specifications

Available chassis:

- 4 channel rack or panel mounted
- 8 channel rack or panel mounted
- 16 channel rack or panel mounted

Number Channels per Module:

The ZN002A requires one channel of chassis space per Module.

The ZN002A provides up to 24 channels in 3 zones per Module.

Warranty:

Two Years

Standards & Regulatory Approvals:

CSA Certified  
 FM approval is pending  
 National Fire Protection Association  
 (NFPA 72A-72E where applicable)

## 2.2 Mechanical Specifications

Length:	9.9 inches	251 mm
Height:	6.825 inches	173 mm
Width:	1.0 inch	25 mm
Weight:	11.2 oz.	318 grams

## 2.3 Electrical Specifications

Operating Power:

24Vdc nominal @ 125mA  
 20 to 35Vdc range  
 ≤ 18Vdc produces a Fault

Open Collector Output Rating:

The electrical rating for the Open Collectors is 100mA max., 35Vdc max.

Electrical Classification:

General purpose for use in non-hazardous locations

## 2.4 Environmental Specifications

Operating temperature range:

0°F to 150°F      -18°C to 66°C

Storage temperature range:

-40°F to 150°F      -40°C to 66°C

Operating humidity range:

5 to 100% relative humidity  
 (non-condensing)





B/01-96

## 2.5 Engineering Specification

**Zero Two System** - Each system shall utilize modules capable of monitoring gas sensing elements or a 0 to 20mA analog signal from gas or flame detection transmitters. The system shall be available in 4, 8 and 16 channels. Each chassis shall contain a bus for the following independent signals:

- A1 Alarm
- A2 Alarm
- Fault
- Master Accept
- Master Reset
- Unaccept
- CAL
- +24Vdc
- System Common

Module signals shall be capable of being bussed from one chassis to another (16 channel chassis only), such that up to 100 modules can comprise a single system.

All Zero Two Series Modules shall be electrically and physically compatible and capable of being used in the same chassis or system to form combined fire and gas detection systems. The minimum output requirements of gas and flame detection modules shall be two open collector outputs dedicated to alarm indications, one open collector output dedicated to fault indications and a current sourcing 4 to 20mA output. The alarm output (open collector) options shall be user selectable.

The system shall consist of Zero Two Series component modules as manufactured by General Monitors (Lake Forest, California, U.S.A. or Galway, Republic of Ireland).

**Model ZN002A** - Each Zone Control Module shall provide voting and zoning logic for three independent zones. Each zone shall accept up to eight inputs (open collector outputs) from other modules in the system.

The polarity of each input shall be DIP switch selectable such that each input for a single zone can have the same polarity. Single (A1) and dual (A2) voting shall be available for each zone in the form of independent front panel LED indications and rear terminal open collector outputs. The logic of the voting outputs shall be DIP switch selectable.

The Zone Control Module shall have the following additional features:

- LED Test
- Card Test
- Low Power "FAULT" LED

The Model ZN002A shall be manufactured by General Monitors (Lake Forest, California, U.S.A. or Galway, Republic of Ireland).



*The Installation chapter discusses what to do when a Model ZN002A is received, the terminal connections & designations and what the user should be aware of when applying power.*

### 3.1 Upon Receipt of Equipment

All equipment shipped by General Monitors is pre-packed in shock absorbing containers which provide considerable protection against physical damage. The contents should be carefully removed and checked against the packing slip. If any damage has occurred or there is any discrepancy in the order, please notify General Monitors as soon as possible. All subsequent correspondence with General Monitors must specify the equipment part number and the serial number. Each item and piece of equipment is completely checked by the factory. However, a complete check-out is necessary upon initial installation and start-up to ensure system integrity.

### 3.2 Chassis Installation

The chassis should be mounted in a non-hazardous, protected environment and should be subjected to a minimum of shock and vibration. In installations where two or more module types have been mixed in one chassis, check that the individual channel coding strips match the channel application. The coding strips are pre-configured at the factory and the male portion is already mounted on each module. The female portion must be fastened in position on the mounting strip so as to mate with its male counter part on the module (see figure 2). Connectors for system expansion should be fastened using the screws provided.

Do not over-tighten the connector or coding strip fasteners as this may damage the plastic molded parts. If more than one chassis is stacked vertically within an enclosure, forced air may be required for adequate cooling.

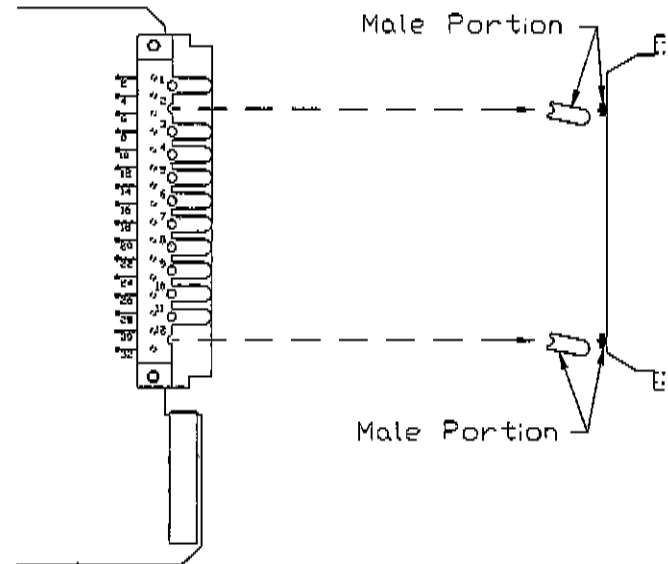

Figure 2

In each chassis, the far right hand channel is dedicated to the Facilities Module. This channel will not accommodate any other module.

### 3.3 Module Installation

Although the Zero Two Series modules are, to a great extent, immune to electromagnetic interference (EMI), they should not be mounted in close proximity to a radio transmitter or similar equipment. These modules require some air circulation to avoid excessive heat build-up inside of an enclosure.



B/01-96

### 3.4 Terminal Connections

All wire connections to the Model ZN002A are made to the terminal block located at the rear of the chassis. The terminal block accepts 16 AWG to 20 AWG, stranded or solid core wire. 14 AWG wire may be used if it is properly stripped according to figure 3.

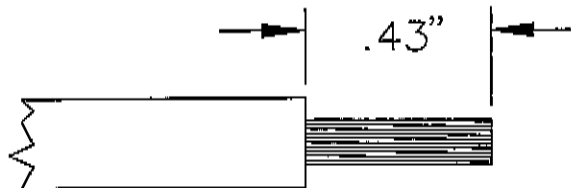

Strip Length

Figure 3

Contact with PC Board components should be avoided in order to prevent damage by *static electricity*. To connect wires to the terminal block, loosen the desired screw, insert the stripped end of the wire and tighten.

For the Gas and Flame Detection Modules, refer to the specific manual for detailed information on terminal connections on those modules. Refer to figure 4 for the terminal designations for the Model ZN002A.

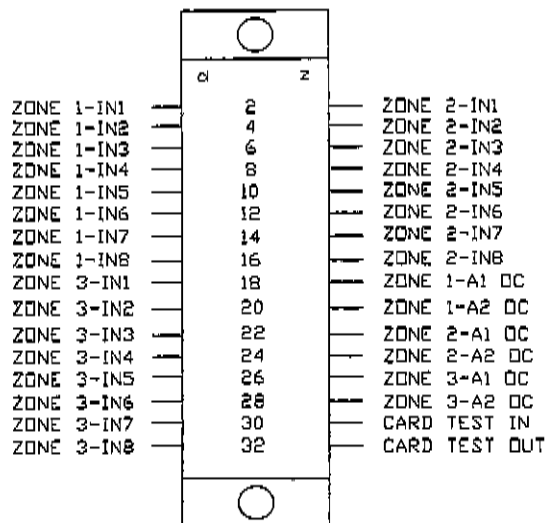

Figure 4

The input terminations for Zone 1 are:

Label	Term	Designation
Zone 1-IN1	2d	Zone 1 - Input 1
Zone 1-IN2	4d	Zone 1 - Input 2
Zone 1-IN3	6d	Zone 1 - Input 3
Zone 1-IN4	8d	Zone 1 - Input 4
Zone 1-IN5	10d	Zone 1 - Input 5
Zone 1-IN6	12d	Zone 1 - Input 6
Zone 1-IN7	14d	Zone 1 - Input 7
Zone 1-IN8	16d	Zone 1 - Input 8

The input terminations for Zone 2 are:

Label	Term	Designation
Zone 2-IN1	2z	Zone 2 - Input 1
Zone 2-IN2	4z	Zone 2 - Input 2
Zone 2-IN3	6z	Zone 2 - Input 3
Zone 2-IN4	8z	Zone 2 - Input 4
Zone 2-IN5	10z	Zone 2 - Input 5
Zone 2-IN6	12z	Zone 2 - Input 6
Zone 2-IN7	14z	Zone 2 - Input 7
Zone 2-IN8	16z	Zone 2 - Input 8

The input terminations for Zone 3 are:

Label	Term	Designation
Zone 3-IN1	18d	Zone 3 - Input 1
Zone 3-IN2	20d	Zone 3 - Input 2
Zone 3-IN3	22d	Zone 3 - Input 3
Zone 3-IN4	24d	Zone 3 - Input 4
Zone 3-IN5	26d	Zone 3 - Input 5
Zone 3-IN6	28d	Zone 3 - Input 6
Zone 3-IN7	30d	Zone 3 - Input 7
Zone 3-IN8	32d	Zone 3 - Input 8

The output and card test terminations are:

Label	Term	Designation
Zone 1-A1	18z	Zone 1-A1 OC
Zone 1-A2	20z	Zone 1-A2 OC
Zone 2-A1	22z	Zone 2-A1 OC
Zone 2-A2	24z	Zone 2-A2 OC
Zone 3-A1	26z	Zone 3-A1 OC
Zone 3-A2	28z	Zone 3-A2 OC
Card Test In	30z	Card Test Termination
Card Test Out	32z	Card Test OC



## Terminal Connections (continued)

OC = Open Collector

All of the input (except Card Test In) terminations accept open collector outputs from other modules in the system. All of the output terminations are open collector outputs. The maximum electrical ratings for the open collector outputs are 35Vdc and 100mA. See figure 5 for typical open collector external circuits.

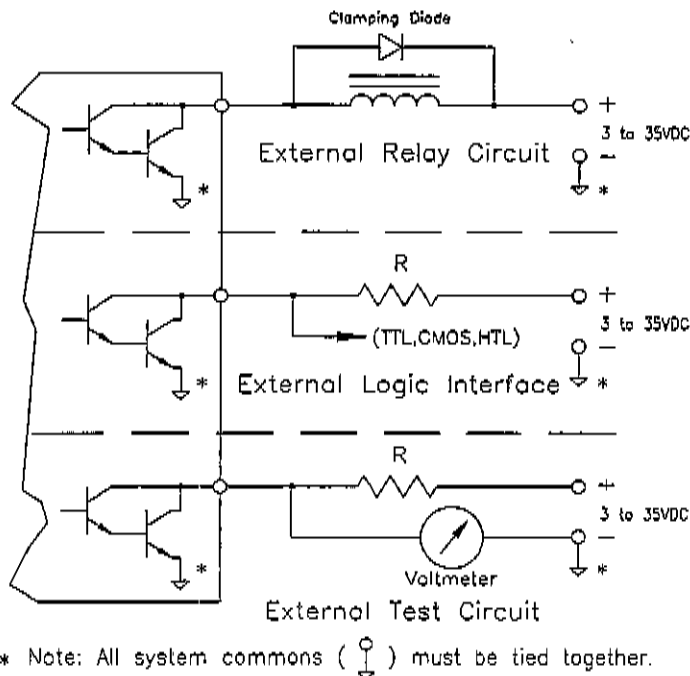

Figure 5

**NOTE:** When any Open Collector Output is connected to a device not powered by the same supply powering the ZN002A, it will be necessary to remove (cut) Jumper W1 (see figure 10 on page 21). The same holds true for any Input (Open Collector) coming from a module that is not powered by the same supply powering the ZN002A.

**NOTE:** No connection should be made to terminal 30z, other than a normally open switch between ground (system common) and the terminal. If required, General Monitors recommends using a single pole, single throw, (SPST) normally open switch.

## 3.5 Applying Power

Zero Two Series Modules do not have an ON/OFF power switch. Each module in the Zero Two Series operates from 24Vdc. Current requirements will vary according to the number and type of modules in the system, as well as the number and type of field devices. General Monitors produces a Power Supply (Model PS002 for use in Non-European Countries) that slides into the chassis. This unit requires 4 consecutive channels (slots) of chassis space and operates from 120Vac or 220Vac.

A rear chassis connector has been provided to allow the use of an external power supply (see figure 6).

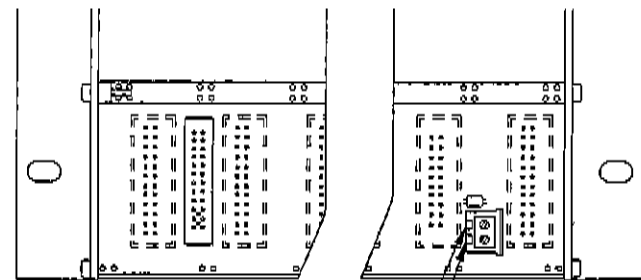

PRIMARY INPUT POWER { POS (+)  
+24 VDC COM (-)

Figure 6

Consult the instruction manual for each module in the chassis to determine how much current will be necessary to drive each module and field device in the system.



*The Operations chapter discusses what general maintenance to perform, describes the electrical inputs, outputs and resetting & accepting the alarms and the fault.*

#### 4.1 General Maintenance

Once the Model ZN002A has been installed, very little maintenance is required other than periodic checks to verify the integrity of the system. The operator should evaluate conditions in the field and determine how frequent calibration / checks should be made. The following list of checks should be made at least annually:

- A functional test of the complete system should be performed including full operation on stand-by or back up power for the prescribed period.
- An LED test of the complete system should be performed. This test verifies the integrity of each front panel LED and each segment of the digital displays.
- All wiring should be checked for tightness, verifying that all of the components and devices are connected correctly.
- Some Zero Two Modules have a software driven user interface. If the "Password" is disabled, periodic checks of the setup parameters should be performed.

#### 4.2 Electrical Inputs

The electrical inputs to the Model ZN002A consist of the +24Vdc & common power connections, the 24 open collectors from other modules and the card test switch connection. The power connections (+24Vdc & common) are accessed from the bus. The open collectors from the other modules provide the Model ZN002A with inputs to the zones.

Open collectors associated with alarm conditions can be in one of two normal states, energized or de-energized. An energized open collector provides a path to common by sinking current. Conversely, a de-energized open collector does not provide a path to common because it does not sink current.

Since open collector outputs are bi-polar, it will be necessary to ensure all the inputs to the same zone have the same polarity (energized or de-energized). The Model ZN002A provides an eight position DIP switch for each zone (see figure 10, page 21, for switch locations) to ensure that input polarities match within each zone. Switch SW1 corresponds with zone 1, SW2 with zone 2 and SW3 with zone 3. Position 1 of a switch (SW1, SW2 or SW3) is associated with the first input (channel) of the zone and position 8 is associated with the eighth input (channel) of the zone. Use the table below to set the polarity of each input into each zone.

Channel	OPEN	CLOSED
1	Inverted Input	Normal Input
2	Inverted Input	Normal Input
3	Inverted Input	Normal Input
4	Inverted Input	Normal Input
5	Inverted Input	Normal Input
6	Inverted Input	Normal Input
7	Inverted Input	Normal Input
8	Inverted Input	Normal Input

The card test switch connection is provided to allow the operator to initiate the card test software routine. This software routine tests the input logic of each channel to each zone.



B/01-96

### Electrical Inputs *(continued)*

The duration of the Card Test is the length of time the test is activated. If the card test routine is accessed by the operator, all the front panel alarm LEDs will flash if the test is successful. An unsuccessful test will cause the Fault LED on the front panel to flash.

### 4.3 Electrical Outputs

The electrical outputs from the Model ZN002A consist of the A1 and A2 voted open collectors for each zone (6 outputs total) and the Card Test Out open collector. The A1 & A2 outputs on the Model ZN002A are unlike the A1 & A2 outputs on the gas and flame detection modules. The A1 & A2 outputs on the Model ZN002A represent levels of voting. The A1 & A2 outputs on the other modules represent degrees of hazard. The A1 & A2 open collectors for each zone represent single voted and dual voted outputs. This means that in order for an A1 output to activate, any input to the zone needs to activate and in order for an A2 output to activate, any two inputs to the zone need to activate. A1 requires one vote and A2 require two votes. There are front panel LEDs that are associated with each A1 and A2 (six total).

The Card Test Out open collector is normally de-energized. When the Card Test is activated this output energizes and remains energized for the duration of the test.

There are 2 kinds of faults that are monitored on the Model ZN002A, low voltage conditions and an unsuccessful card test. A low voltage condition or fault will occur when the input voltage to the Model ZN002A drops below 20Vdc, however the unit will continue to operate as low as 18Vdc.

### 4.4 Accepting Alarm Conditions

Whenever an input activates, the A1 LED, and possibly the A2 LED, for that zone will begin to flash (ZN002A only). This flashing front panel LED indicates that a new condition/alarm has occurred. On some Zero Two Modules (not the ZN002A), the unaccept (UA) outputs will activate. New conditions/alarms should be acknowledged or accepted. This is accomplished with the Master Accept Button located on the Facilities Module (FM002A). Pressing the Master Accept Button de-activates all unaccept outputs and causes the flashing front panel LEDs to stop flashing. The front panel LEDs will remain on until reset, automatically or manually.

There is a unique situation that may occur with some frequency in certain applications. An alarm may occur and the operator will accept it by pressing the Master Accept Button. If the output is latching and the condition that caused the alarm is no longer present, the output will need to be reset as stated in section 4.5 of this chapter. If, however, the output is not reset and a similar condition causes the same alarm to occur, the front panel LED will reflash or re-activate. This gives the operator an indication of a new alarm condition that must be re-accepted.

On some modules, a Fault Unaccept (FUA) output will activate. Whenever a fault condition occurs, the front panel LED will begin to flash. If the operator presses the Master Accept Button, the LED will stop flashing but stay on until the condition that caused the fault is no longer present. Fault outputs are always non-latching, they reset automatically.

**NOTE:** *The Model ZN002A does not have a Fault Unaccept output.*



#### 4.5 Resetting Latched Alarms

The operator may select a latching or non-latching output for A1 and/or A2. See section 4.6 of this chapter for selecting latching and/or non-latching output options. If an output activates and the input(s) that caused the activation de-activates, a non-latching output will reset automatically, whereas a latched output will need to be reset manually.

Resetting latched outputs is accomplished with the Master Reset Button located on the Facilities Module (FM002A). Pressing the Master Reset Button will reset any latched condition in the system, provided the condition that caused the output to latch is no longer present.

#### **LED Test**

As discussed in Chapter 1 (Introduction), the Master Reset Button performs another function. If the operator presses and holds the Master Reset Button for two or more seconds, all of the LEDs and LED segments on each module in the system will illuminate for as long as the operator presses the button. This is called the LED Test.

#### 4.6 User Selectable Options

The SW5 DIP switch is reserved for user selectable options. The table below lists the switch selectable options and their settings:

Position	OPEN	CLOSED
1	Zone 1, A1 Open Collector Inverted Output	Zone 1, A1 Open Collector Normal Output
2	Zone 1, A2 Open Collector Inverted Output	Zone 1, A2 Open Collector Normal Output
3	Zone 2, A1 Open Collector Inverted Output	Zone 2, A1 Open Collector Normal Output
4	Zone 2, A2 Open Collector Inverted Output	Zone 2, A2 Open Collector Normal Output
5	Zone 3, A1 Open Collector Inverted Output	Zone 3, A1 Open Collector Normal Output
6	Zone 3, A2 Open Collector Inverted Output	Zone 3, A2 Open Collector Normal Output
7	Latching A2 Open Collector Outputs	Non-Latching A2 Open Collector Outputs
8	Latching A1 Open Collector Outputs	Non-Latching A1 Open Collector Outputs



## Glossary of Terms

**AC** - Alternating Current.

**Alarm Set Point** - This is a fixed value that can be set by the user. When this value is exceeded, the microprocessor will activate the Alarm Relay.

**Ambient Temperature** - Surrounding or background temperature.

**Analog** - Continuous, without steps.

**AWG** - American Wire Gauge.

**Calibration** - Applying a known level of gas to a sensor and making adjustments so that the output signal matches the level of gas applied.

**Canadian Standards Association** - CSA is an approval agency. Testing laboratories will test Gas Detection Equipment to the standards that are set by approval agencies such as CSA. CSA certification is required for selling such equipment in Canada. CSA standards are recognized by many organizations outside of Canada.

**Class I, Division 1, Groups B, C & D** - This is a National Electric Code (NEC) classification dealing with hazardous locations, the degree with which the hazard is present, and the type of hazard that is present.

**Class I, Division 1** is defined as any location where ignitable concentrations of flammable gases or vapors may be present under normal operating conditions.

**COM** - Common.

**Conduit** - Tubing, pipe or a protected trough for electrical wires.

**DC** - Direct Current.

**DCS** - Distributed Control System.

**De-Energized** - A relay is de-energized when it is at mechanical rest. That is, the position of the contacts will not change until power is applied to the relay.

**Digital** - Stepped in specific increments.

**DPDT** - Double Pole Double Throw. Each Pole is set of throws. Each Throw is a normally open or closed set of contacts. A double throw is one of each. So a DPDT relay has 2 open and 2 closed sets of contacts.

**Drain Loop** - The purpose of a drain loop is to collect condensation so as to prevent moisture from entering the housing.

**Energized** - When a relay is energized, power is applied to the relay such that the contacts are held in a position for as long as the power is applied.

**FM** - Factory Mutual Research Laboratory.

**Groups B, C & D** refers to the type of gases or vapors.

**Group B** is atmospheres containing more than 30% Hydrogen or gases/vapors of equivalent hazard.

**Group C** is atmospheres such as cyclopropane, ethyl ether, ethylene, or gases/vapors of equivalent hazard.

**Group D** is atmospheres such as acetone, ammonia, benzene, butane, ethanol, gasoline, hexane, methanol, methane, natural gas, naphtha, propane, or gases/vapors of equivalent hazard. For more information on Hazardous Locations, refer to the National Electrical Code, Article 500.





B/01-96

**Glossary of Terms** (*continued*)

**Latching** - To latch is to hold on to. A latching condition is a result of a condition occurring and going away, but the signal will be held by the electronics until manually reset.

**mA** - Milliampere, One thousandth (.001) of an amp.

**Microprocessor Based Electronics** - All of the input signal processing, fault monitoring, calibrating routines, and the outputs are controlled by a microprocessor.

**MPU** - Microprocessor Unit.

**Non-Latching** - A non-latching condition exists when the signal follows the condition (i.e. if a condition occurs a signal occurs; if the condition returns to normal, the signal returns to normal). The signal automatically resets.

**PLC** - Programmable Logic Controller.

**Potentiometer** - An adjustable resistor.

**RFI** - Radio Frequency Interference.

**SPST** - Single Pole Single Throw. Each Pole is set of throws. Each Throw is a normally open or closed set of contacts. A double throw is one of each. So an SPST relay has 1 open or 1 closed set of contacts.

**TB** - Terminal Block.

**Voting** - The number of channels within the same zone required to activate an alarm.

*A1 Voting requires 1 channel within the zone to activate the A1 output for that zone. A2 Voting requires 2 channels within that zone to activate the A2 output for that zone.*



# Engineering Documentation

## Schematic Diagram - Display Board

Reference Drawing # 11237-2

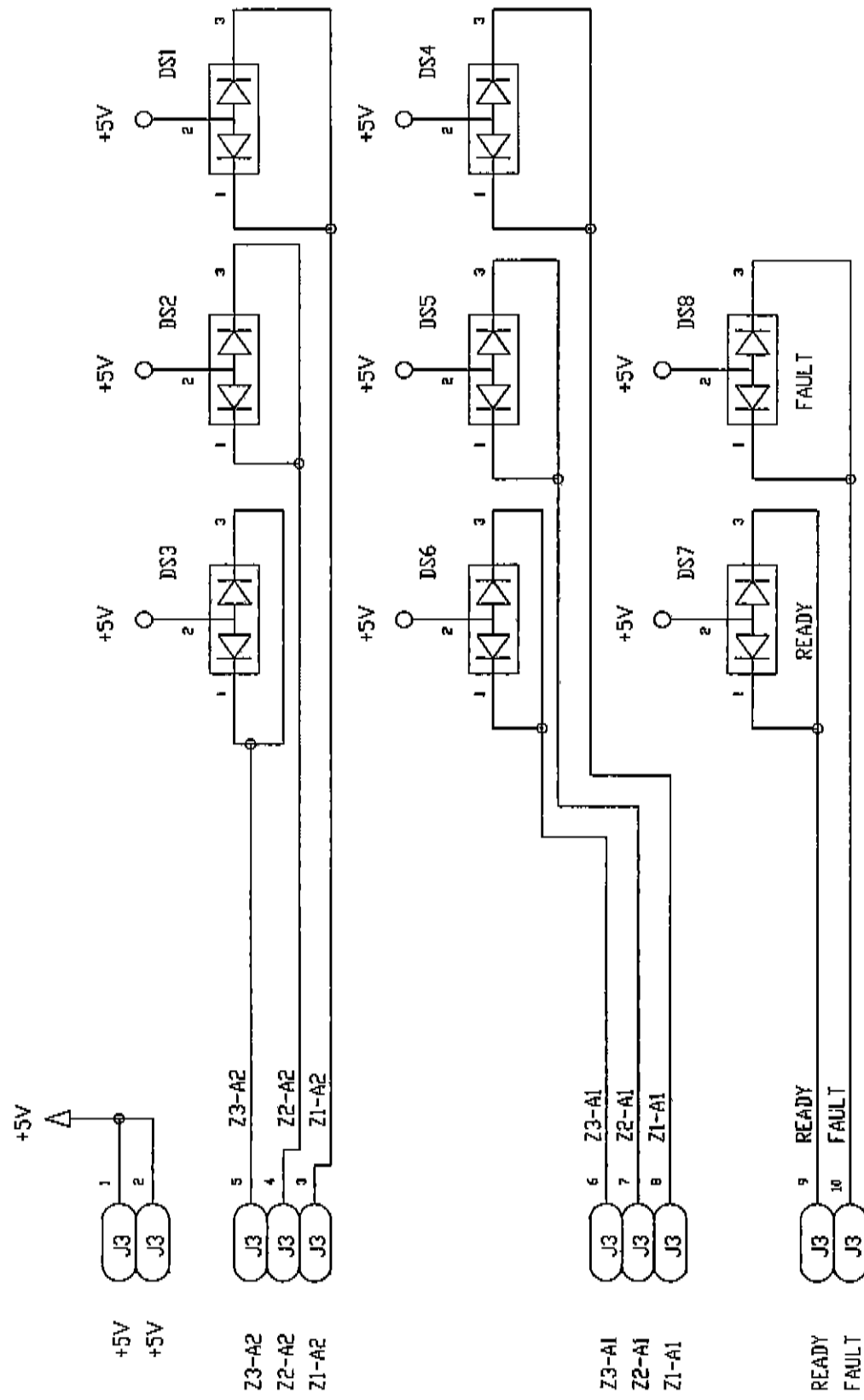

Figure 7



B/01-96

Engineering Documentation (continued)

Schematic Diagram - Control Board

Reference Drawing # 11233-2

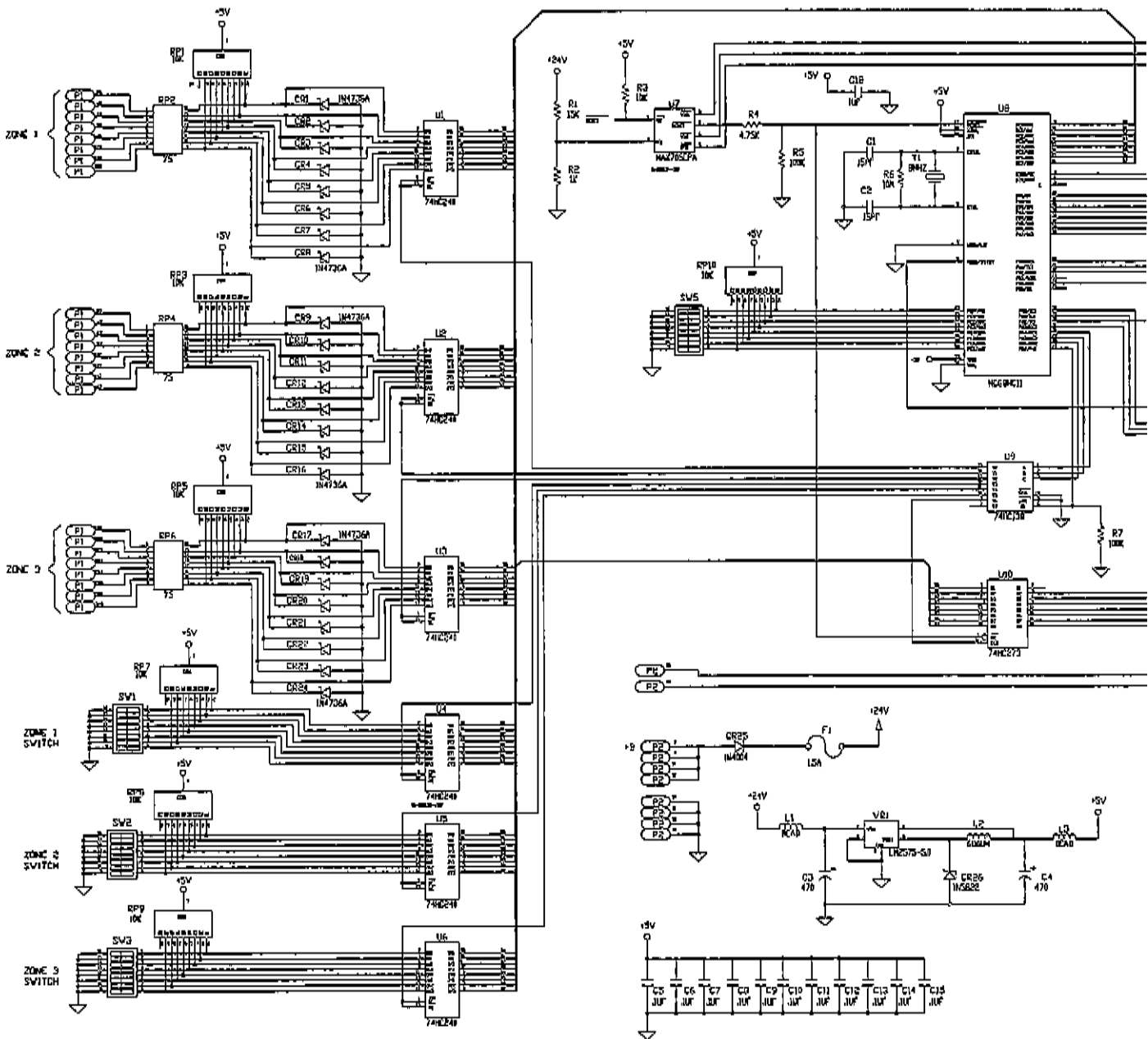

Figure 8

Left Side



Engineering Documentation (continued)

Schematic Diagram - Control Board

Reference Drawing # 11233-2

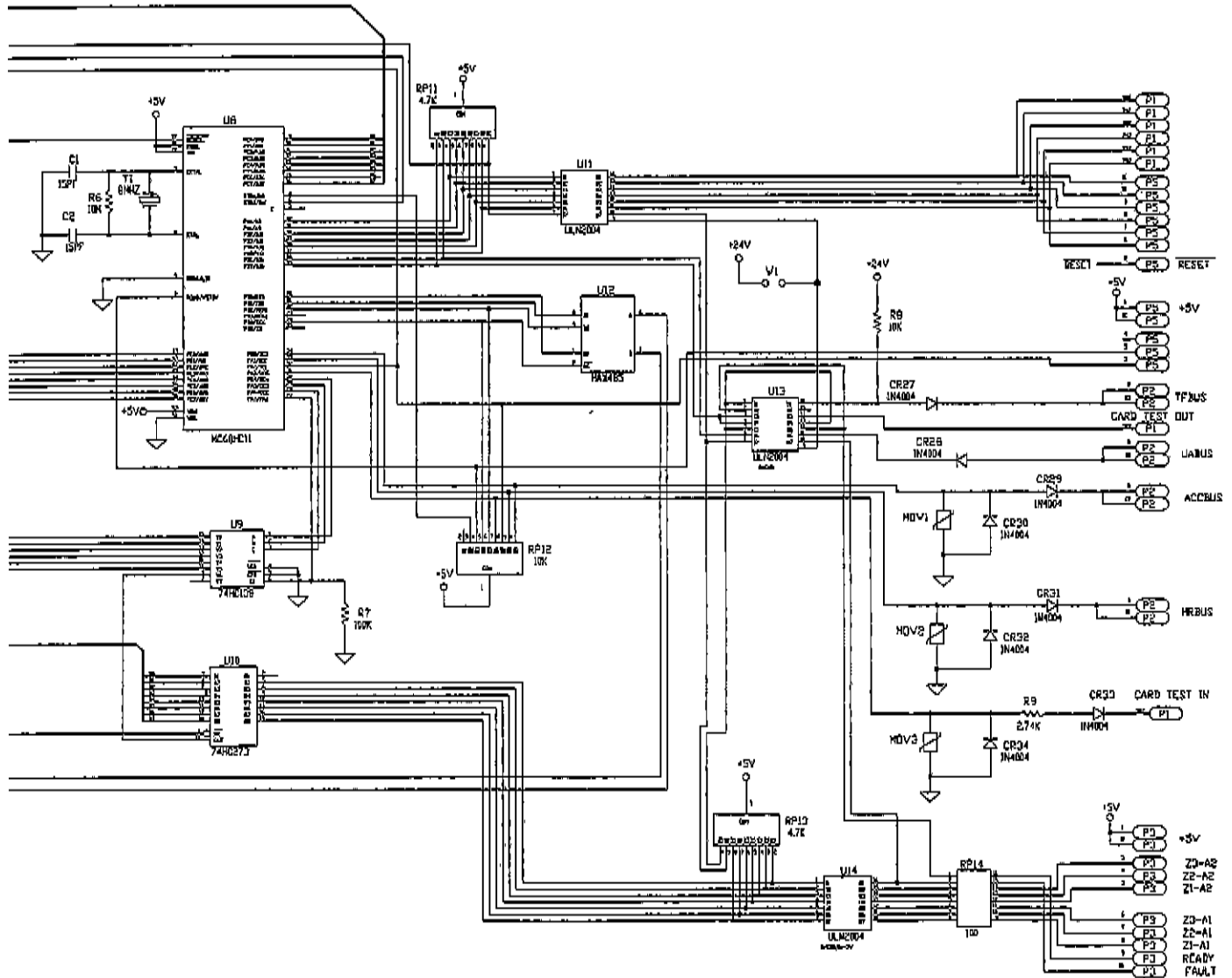

Figure 8  
Right Side



B/01-96

Engineering Documentation (continued)

Circuit Card Assembly - Display Board

Reference Drawing # 11238-2

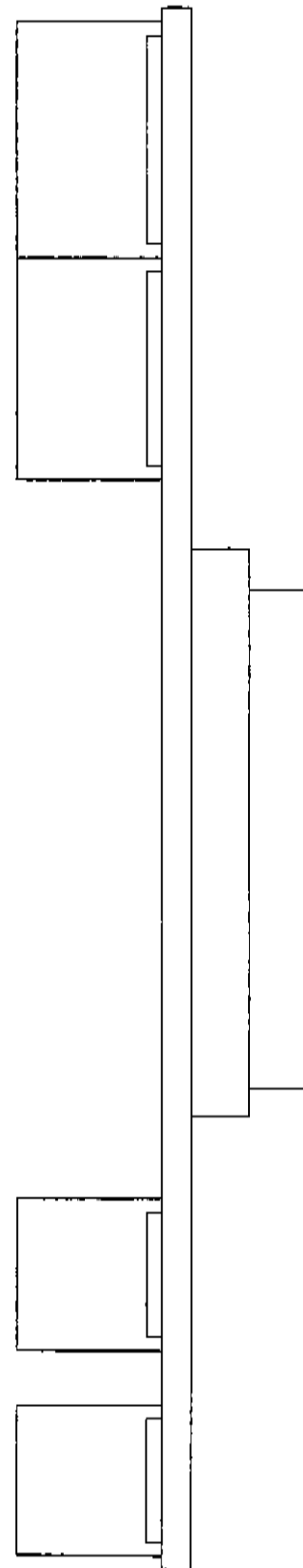
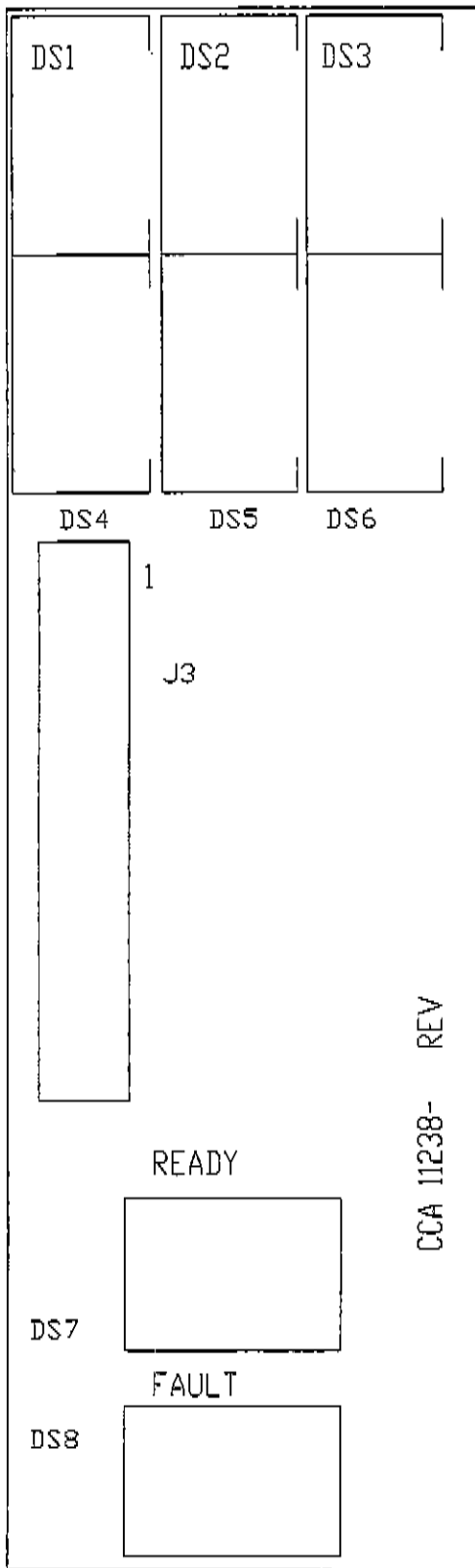

Figure 9



Engineering Documentation (continued)

Circuit Card Assembly - Control Board

Reference Drawing # 11234-2

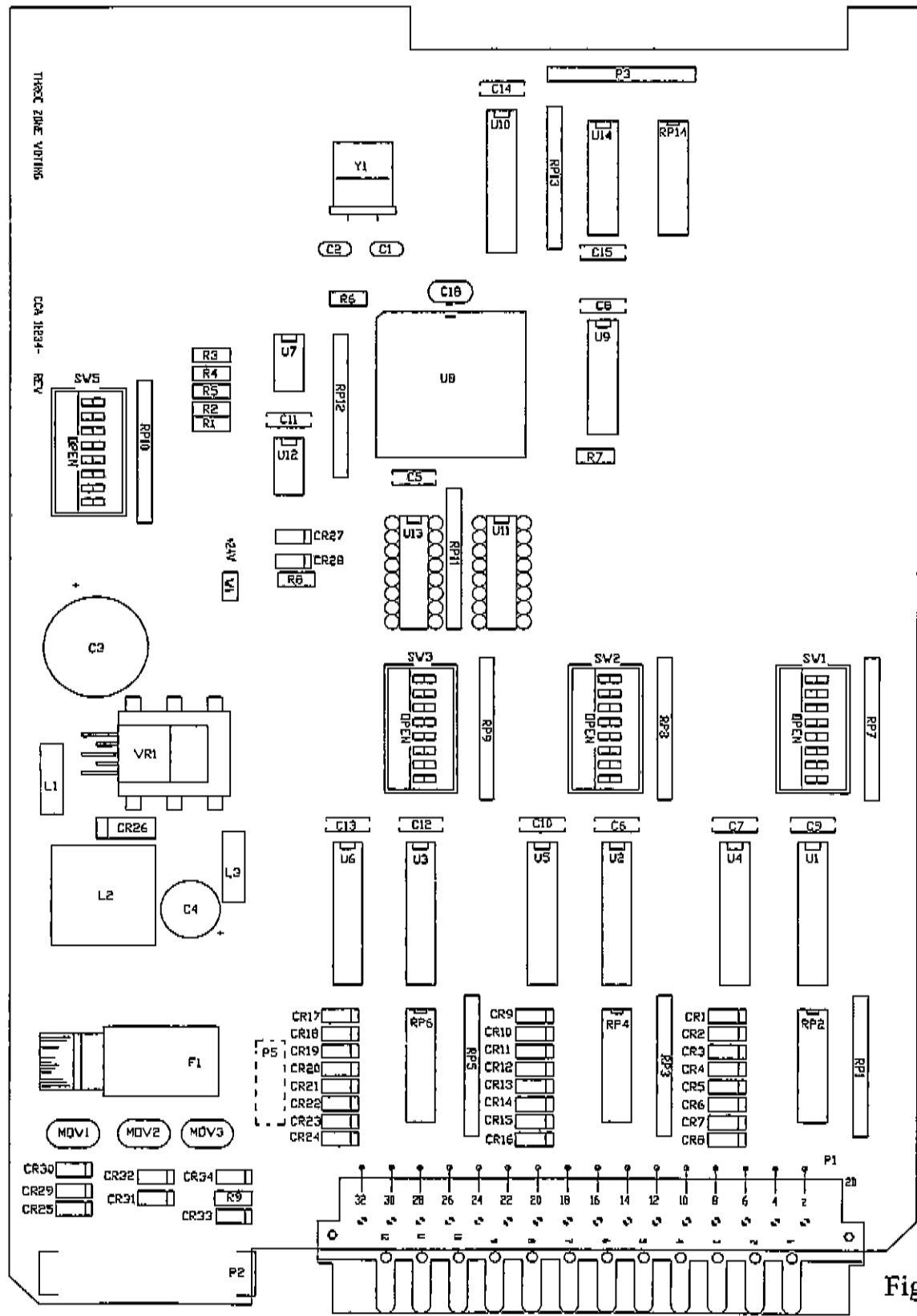

Figure 10



B/01-96

Engineering Documentation (continued)

Outline & Dimensional Drawing - ZN002A

Reference Drawing # 11231-1

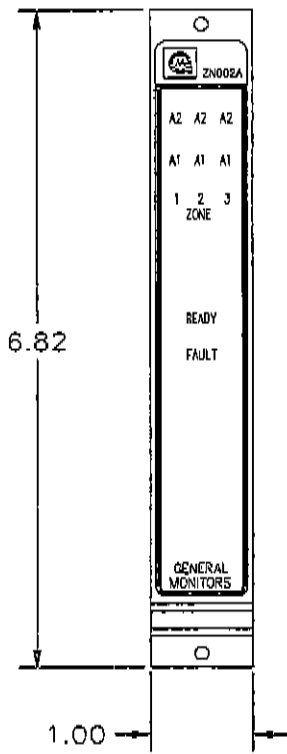
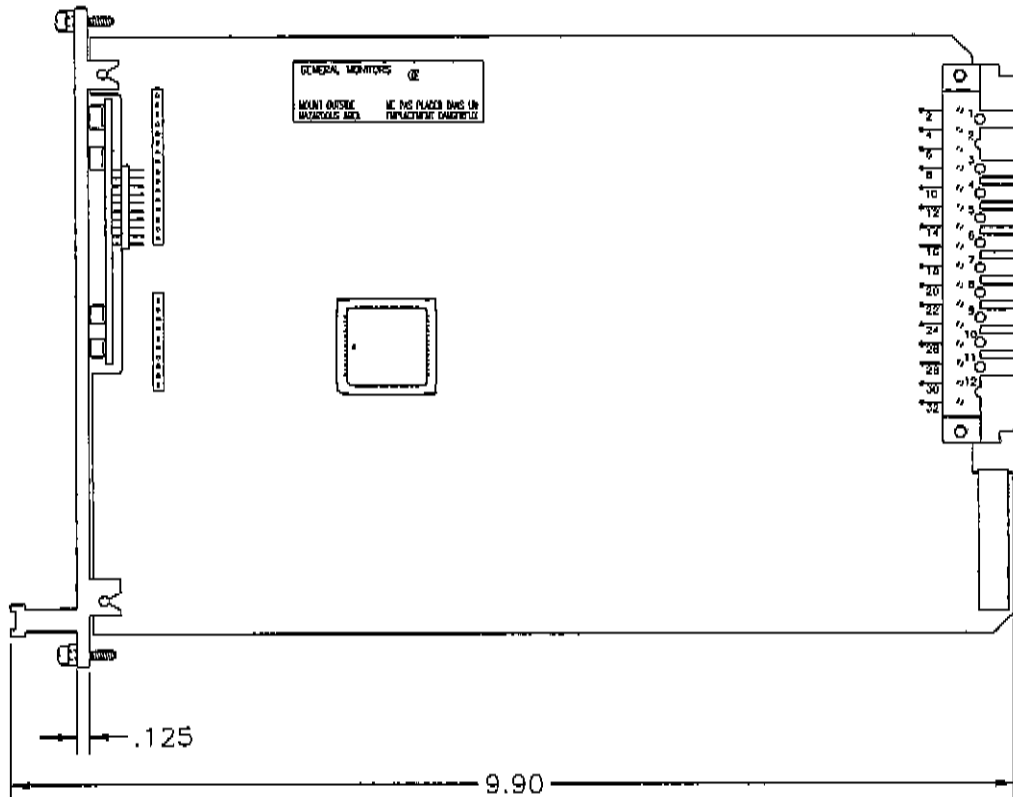

REAR CONNECTOR TERMINATIONS

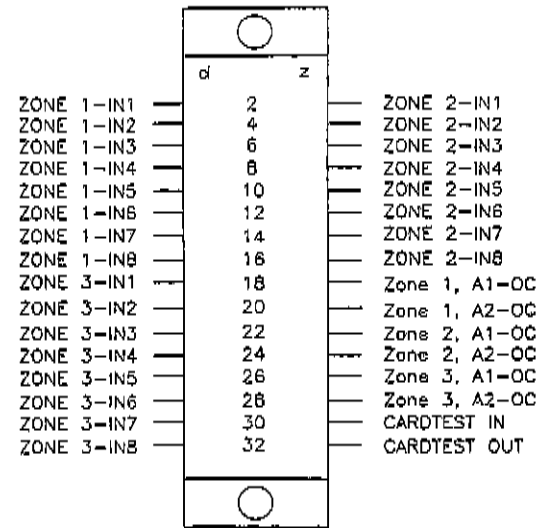

DIMENSIONS  
— INCH(mm) —

Figure 11



Engineering Documentation (continued)

Final Assembly Drawing - Model ZN002A

Reference Drawing # 11230-1

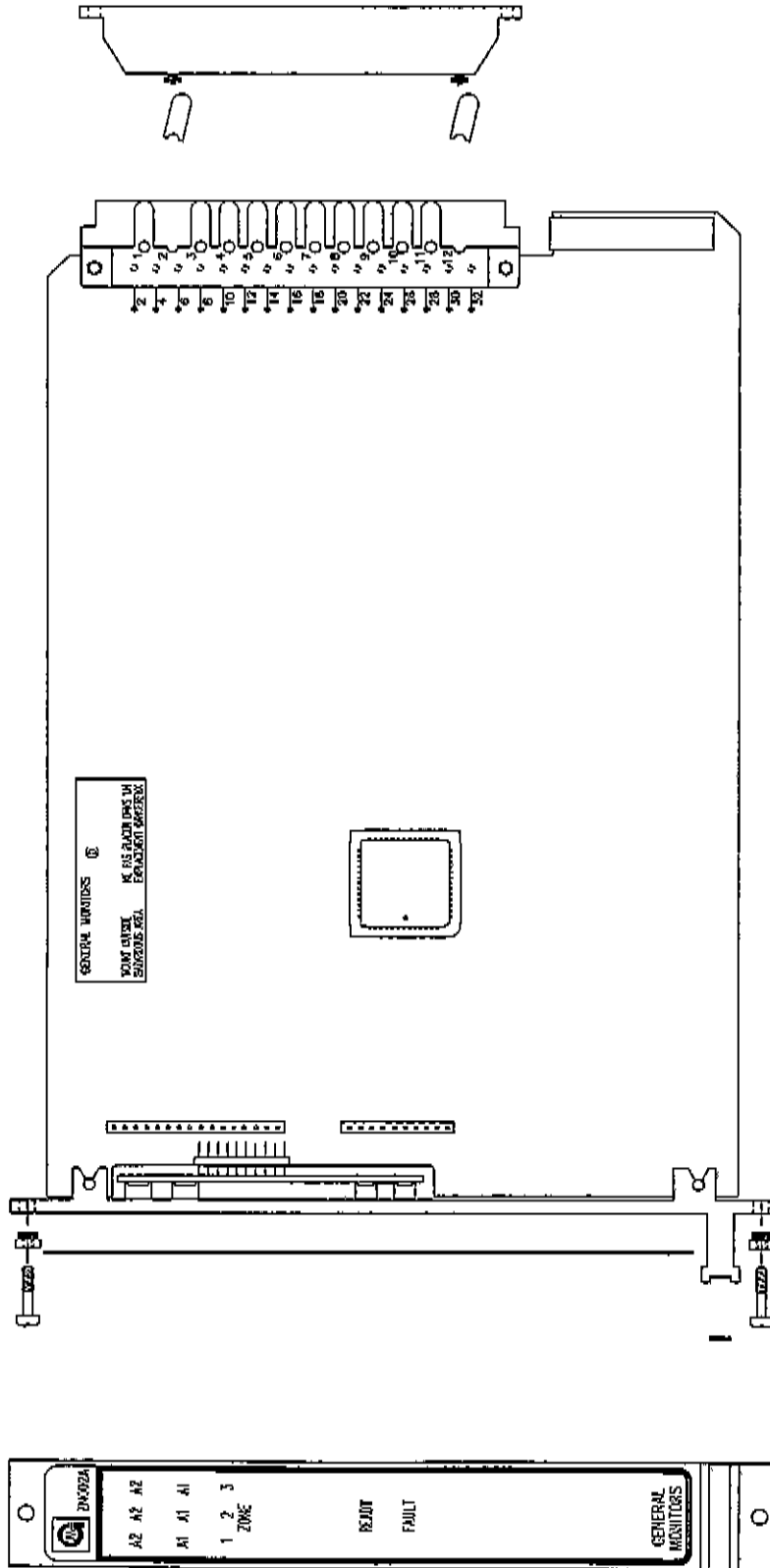

Figure 12



**Zero Two Series Modules****Model 2602A**

Zero Two Series Control Module  
for Hydrogen Sulfide Gas  
Applications

---

**Model 4802A**

Zero Two Series Control Module  
for Combustible Gas  
Applications

---

**Model TA102A**

Zero Two Series Trip Amplifier  
for Combustible Gas  
Applications

---

**Model TA202A**

Zero Two Series Trip Amplifier Module  
for Hydrogen Sulfide Gas  
Applications

---

**Model TA402A**

Zero Two Series Trip Amplifier Module  
for Flame Detection  
Applications

---

**Model FM002A**

Zero Two Series Facilities Module  
Performs Common Functions  
for Zero Two Systems

---

**Model RL002**

Zero Two Series Relay Module  
Provides Extra Output Capacity  
for Zero Two Systems

---

**Model ZN002A**

Zero Two Series Zone Control Module  
Performs Zoning & Voting Functions  
for Zero Two Systems

---

**Model MD002**

Zero Two Series Monitored Driver Card  
for Monitoring / Driving High Current  
Output Devices

---

**Model IN042**

Zero Two Series Four Input Zone Card  
for Callpoints, Smoke & Thermal  
Detection Applications

---

**\*\* Model PS002 \*\***

Zero Two Series Power Supply Module  
for Zero Two Systems

\* = The Model PS002 is designed for use in Non-EU countries only.