

# V-Gard® Headgear

Face Protection from MSA



V-Gard Headgear are designed to work with V-Gard Visors and Chin Protectors, and meet many global standards, including ANSI/ISEA Z87.1-2010, CSA Z94.3, EN166 and AS/NZS 1337.

Convenient. Compliant. Compatible.



*Because every life has a **purpose...***

## V-Gard General Purpose Headgear: Key Features

V-Gard Headgear works with 30+ V-Gard Visors<sup>1</sup> to offer a lightweight, comprehensive face protection system that can be used when a hard hat is not needed.



V-Gard General Purpose Headgear (PN 10127061). Shown with V-Gard Contoured Clear PC Visor (PN 10115836). These products are sold separately, but can be purchased together (V-Gard Headgear General Purpose Kit, PN 10127063).

<sup>1</sup> **DO NOT** use V-Gard Headgear with V-Gard Arc Visors tested to ASTM F2178-2008 Test Method (ref. NFPA 70E-2012, Hazard Risk Category). These visors are designated for use with specified V-Gard Frames and MSA helmets **ONLY** as face protection for workers exposed to high voltage electric arcs. V-Gard Headgear has not been tested or certified to the Test Method, and should not be used for this type of Arc Flash protection.

<sup>2</sup> Patent pending

## V-Gard Elevated Temperature Headgear: Key Features

V-Gard Elevated Temperature Headgear has been tested to withstand radiant heat up to 400°F<sup>1</sup>. V-Gard Headgear in combination with V-Gard Visors<sup>2</sup> offer a comprehensive face protection system that can be used when a hard hat is not needed.



V-Gard Elevated Temperature Headgear (PN 10127062). Shown with V-Gard Reflective-Coated Green Tint PC Visor (PN 10115850). These products are sold separately, but can be purchased together (V-Gard Headgear Elevated Temperature Kit, PN 10127064).

<sup>1</sup> Exposure to extreme heat can cause thermal discomfort. Proper precautions should be taken to prevent heat stress.

<sup>2</sup> **DO NOT** use V-Gard Headgear with V-Gard Arc Visors tested to ASTM F2178-2008 Test Method (ref. NFPA 70E-2012, Hazard Risk Category). These visors are designated for use with specified V-Gard Frames and MSA helmets **ONLY** as face protection for workers exposed to high voltage electric arcs. V-Gard Headgear has not been tested or certified to the Test Method, and should not be used for this type of Arc Flash protection.

<sup>3</sup> Patent pending

## V-Gard General Purpose Headgear

|                               |   |
|-------------------------------|---|
| <b>Classification:</b>        | General purpose   |
| <b>Market(s):</b>             | General industry, manufacturing, repair and maintenance, construction, oil and gas, forestry, shipbuilding, metalworking, automotive, mining, chemical industries |
| <b>Application(s):</b>        | Chipping, splash, chiseling, drilling, grinding, machining, power fastening, sanding, sawing, laboratory  |
| <b>Material:</b>              | High Density Polyethylene (HDPE)  |
| <b>Color(s):</b>              | Black   |
| <b>Available Styles:</b>      | Ratchet closure   |
| <b>Size:</b>                  | Standard (6½ – 8)   |
| <b>Standards<sup>1</sup>:</b> | ANSI/ISEA Z87.1-2010; EN 166; CSA Z94.3; and AS/NZS 1337  |
| <b>Certification:</b>         | Third-party by Intertek, INSPEC International Ltd., CSA International and SAI Global Ltd.   |

### Ordering Information

| V-GARD HEADGEAR FOR GENERAL PURPOSE   | Part No. | Product Specifics  |
|---|----------|--|
|  | 10127061 | <ul style="list-style-type: none"> <li>• Patent-pending, Infini-just lift/closure with grippable knobs that don't unscrew; no parts to lose!</li> <li>• Seven-point crown adjustment</li> <li>• Replaceable, sweat-wicking, cushioned headband helps keep workers dry and cool</li> <li>• Sweat-wicking ratchet cover keeps nape comfortable</li> <li>• For use ONLY with V-Gard Visors; <b>not for use where head protection is required</b></li> <li>• All non-metal construction</li> </ul> |

## V-Gard Elevated Temperature Headgear

|                               |  |
|-------------------------------|--|
| <b>Classification:</b>        | Elevated temperature   |
| <b>Market(s):</b>             | Food manufacturing/canneries, steel mills, construction, open-pit mining, agriculture, oil/gas/petrochemical refineries, rubber manufacturing, and steam tunnels |
| <b>Application(s):</b>        | Food processing, machine operation, maintenance, millwright, cutting, punching, extrusion, drilling, blasting, casting/conveying, chemical mixing, sanding       |
| <b>Material:</b>              | Heat-Resistant Nylon   |
| <b>Color(s):</b>              | Grey   |
| <b>Available Styles:</b>      | Ratchet closure  |
| <b>Size:</b>                  | Standard (6½ – 8)  |
| <b>Standards<sup>1</sup>:</b> | ANSI/ISEA Z87.1-2010; EN 166; CSA Z94.3; and AS/NZS 1337   |
| <b>Certification:</b>         | Third-party by Intertek, INSPEC International Ltd., CSA International and SAI Global Ltd.  |

### Ordering Information

| V-GARD HEADGEAR FOR ELEVATED TEMPERATURES   | Part No. | Product Specifics   |
|---|----------|---|
|  | 10127062 | <ul style="list-style-type: none"> <li>• Extended browguard for additional coverage in high temperatures</li> <li>• Tested to withstand temperatures up to 400°F<sup>2</sup></li> <li>• Patent-pending, Infini-just lift/closure with grippable knobs that don't unscrew; no parts to lose!</li> <li>• Seven-point crown adjustment</li> <li>• Replaceable, sweat-wicking, cushioned headband helps keep workers dry and cool</li> <li>• Sweat-wicking ratchet cover keeps nape comfortable</li> <li>• For use ONLY with V-Gard Visors; <b>not for use where head protection is required</b></li> <li>• All non-metal construction</li> </ul> |





<sup>1</sup> Standards requirements met by each V-Gard Headgear/V-Gard Visor combination designated on each V-Gard Visor.

<sup>2</sup> Exposure to extreme heat can cause thermal discomfort. Proper precautions should be taken to prevent heat stress and other injuries.

## Choosing the Proper V-Gard Visor

The V-Gard Accessory System includes a full line of V-Gard Visors for a variety of applications: from general purpose to elevated temperature. Many V-Gard Visors are designed for use with V-Gard Chin Protectors (look for visors noted as "Nitrometers"). And since V-Gard Visors fit V-Gard Headgear, it's easy to select a combination that is compliant and meets just about any safety need.

When choosing a V-Gard Visor, first assess possible environmental hazards. Is there excessive glare, humidity or exposure to infrared (IR) radiation? Is there a risk of impact, chemical splash or both? The chart below lists the benefits of different V-Gard Visors.

|                   |   |   |
|-------------------|---|---|
| <b>MATERIAL</b>   | Polycarbonate   | Suitable for most applications where impact hazards exist. Available in a variety of sizes and thicknesses. Provides Ultraviolet (UV) protection, where noted. Molded polycarbonate visors also provide protection against some chemical splash. <i>See Chemical Application Quick Reference Guide.</i> |
|                   | Mesh  | Provides maximum ventilation in humid working conditions. Lightweight and durable – great for outdoor applications such as brush clearing and trimming. <b>Does not provide impact, splash or UV protection.</b>  |
|                   | Propionate  | V-Gard propionate visors provide impact resistance. Good for many applications where chemical splash hazards exist. <i>See Chemical Application Quick Reference Guide.</i>  |
| <b>COLOR/TINT</b> | Clear<br>                        | Provides maximum light transmission. Good for indoor applications, or outdoor use in low-light conditions.  |
|                   | Green Tint<br>                  | Helps alleviate eye strain and fatigue by reducing excessive glare and light transmittance. All green tint V-Gard Visors offer maximum UV protection. Great for outdoor use in bright-light conditions. <b>Not for use where an IR shade visor is required.</b>   |
|                   | Shade 3 IR /<br>Shade 5 IR<br> | Helps protect against IR up to Shade 3 or Shade 5, as applicable. Perfect for welding, metal pouring, gas soldering, light cutting, and brazing applications.   |
| <b>COATINGS</b>   | Anti-fog  | Controls condensation build-up on inside of visor surface. Great for humid conditions. V-Gard Molded Visors offering anti-fog are marked with an EN "N" marking, having passed strenuous testing to confirm anti-fogging properties.  |
|                   | Anti-scratch  | Provides excellent scratch resistance, extending visor life. A "must have" in abrasive work environments. V-Gard Molded Visors offering anti-scratch are marked with an EN "K" marking, having passed strenuous testing to confirm anti-scratch properties.   |
|                   | Reflective  | Helps protect against long-term IR exposure generated in elevated temperature environments (EN 166 "R" mark). Coating also helps dissipate heat felt by wearer. Available in clear or green tint. Offers maximum UV protection.   |

### WARNING

Wear MSA impact-rated spectacles or goggles under visors. Inspect visors frequently and replace immediately if worn, scratched or damaged. Use V-Gard Visors **ONLY** with V-Gard Frames, V-Gard Headgear and V-Gard Chin Protectors to ensure compliance with ANSI/ISEA Z87.1-2010, EN 166, CSA Z94.3, and AS/NZS 1337, as well as many local standards. Misuse can result in death, permanent impairment of sight or other serious injury.

**DO NOT** use V-Gard Headgear with V-Gard Arc Visors tested to ASTM F2178-2008 Test Method (ref. NFPA 70E-2012, Hazard Risk Category). These visors are designated for use with specified V-Gard Frames and MSA helmets **ONLY** as face protection for workers exposed to high voltage electric arcs. V-Gard Headgear has not been tested or certified to the Test Method, and should not be used for this type of Arc Flash protection.

## V-Gard Visors: How to Interpret Markings

Many V-Gard Visors meet performance criteria other than those addressed in the ANSI/ISEA Z87.1-2010 Standard. There are for example, performance criteria in EN166 that are not covered in ANSI/ISEA Z87.1-2010, including:

- Resistance to high speed particles at extremes of temperature (-23°F and 131°F)
- Molten metal and hot solids
- Enhanced reflectance
- Anti-fog and anti-scratch

The chart below will aid in interpretation of the EN markings that appear on V-Gard Visors (in required order of appearance, when applicable):

| DESCRIPTION  | EN166 mark on V-Gard Visors | Explanation  | Other comments   |
|--|-----------------------------|--|--|
| FILTER CLASS   | 2, 2C, 4                    | 2C indicates a UV filter that allows good color recognition<br>2 indicates a UV filter that may affect color recognition<br>4 indicates an Infrared (IR) filter  | 2C or 2 markings indicate filtration of UV >99.9% up to 385 nm<br>4 is generally a welding filter  |
| SCALE NUMBER   | 1.2 to 5                    | 1.2 (clear) to 5 (dark tint)<br>Increases with decreasing luminous transmittance of lens   | The light transmission values follow the UV filter indicator in sequence (i.e., "2C-1.2")  |
| SHADE  | 1.2-10                      | From Shade 1.2 to Shade 10   | V-Gard Visors are marked for both IR filtering and welding (i.e., 4-5/5)   |
| MANUFACTURER   | Company identifier          | MSA  |  |
| OPTICAL CLASS  | 1                           | 1 = high optical quality   | All MSA visors are designed for permanent wear   |
| MECHANICAL STRENGTH (OR IMPACT RATING)   | F or B                      | F = low energy impact, 147 ft/s<br>B = medium energy impact, 393 ft/s  | "F" mark is found on V-Gard mesh visors only<br>"B" mark is found on EN166 certified V-Gard PC and propionate visors<br>ANSI/ISEA Z87.1-2010 impact tests for faceshields are conducted at 300 ft/s  |
| LIQUID SPLASH  | 3                           | Resistance to liquids (droplet or splashes)  | Various MSA PC and Propionate visors offer protection against droplets and splashes of liquids   |
| RESISTANCE TO HIGH SPEED PARTICLES AT EXTREMES OF TEMPERATURE (-23°F AND +131°F) | T                           | The visors are conditioned to low and high temperatures (as shown), then impact tested   | Can be seen in conjunction with the impact ratings shown above   |
| RESISTANCE TO SHORT CIRCUIT ELECTRIC ARC   | 8                           | Faceshield minimum thickness 1.4mm; and a scale number of 2-1,2 or 2C-1,2  | In North America, the electrical arc standard is NFPA 70E-2012.<br><b>Visors having an EN166 "8" DO NOT meet the performance criteria in NFPA 70E and should not be used in North America for protection against electrical arc.</b>                                     |
| MOLTEN METAL AND HOT SOLIDS  | 9                           | Molten Metal Test: a sample of Grey iron (2642°F+ 68°F) and molten aluminum (1382°F+ 68°F) are ejected onto the visor and must not adhere.<br>Hot Solids Test: a steel ball (1652+ 68°F) is dropped onto the material and must not penetrate for at least 10s. | V-Gard Frames and debris control, as well as V-Gard Headgear, were checked by MSA engineering against Hot Solids using this same methodology; this test is not required for frames or headgear in any Standard.  |
| RESISTANCE TO SCRATCHING   | K                           | Optional requirement   | Visors samples are rotated on a plate while 6.6 lbs (+ 0.11 lb) of natural quartz sand is dropped from a nearly 5 ft tall gravity-fed tube. Once the test is complete, the samples are cleaned and the measured light transmission must remain within tolerance.         |
| RESISTANCE TO FOGGING  | N                           | Optional requirement   | Visor samples conditioned to water, air and relative humidity are subjected to water vapor (steam). The time required for the light transmission levels to drop to 80% of the unfogged baseline is measured, and visors must remain fog-free for a minimum of 8 seconds. |
| ENHANCED REFLECTANCE   | R                           | Optional requirement   | >60% mean spectral reflectance in the infrared (IR) wavelengths between 780 nm to 2000 nm - the wavelengths specified are known to cause tissue damage to eyes.  |

To understand which EN166 performance criteria V-Gard Visors have passed, check the markings on the visor itself. The markings are generally found on the upper right side of the visor when the visor is facing you. Below are a few examples to guide you a better understanding these markings.

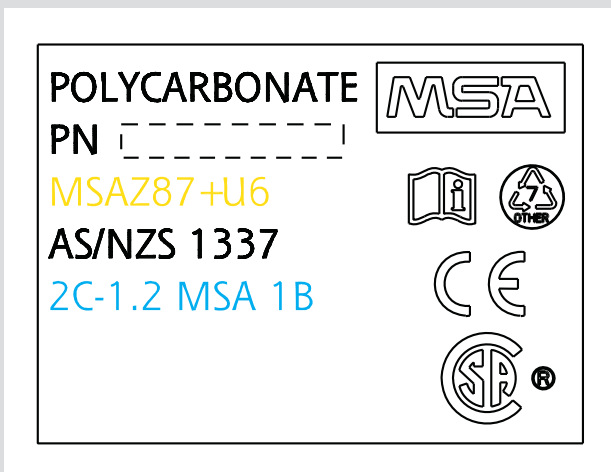

First marking line (in yellow) shows the visor is impact-rated to ANSI/ISEA Z87.1-2010 (Z87+), and offers maximum UV filter (U6) as indicated under the standard.

Last line (in light blue) shows the EN166 markings. In this example, the visor offers a good color recognition UV filter (2C); luminous transmittance > 74.4% (1.2); is made by MSA (MSA); offers the best optical quality (1) and medium energy impact resistance (B).

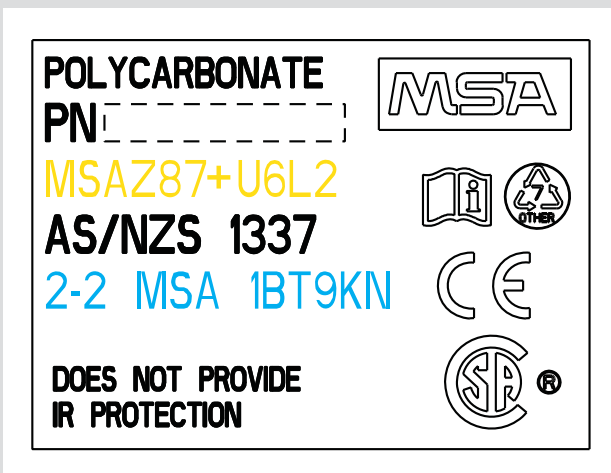

First marking line (in yellow) shows the visor is impact-rated to ANSI/ISEA Z87.1-2010 (Z87+), offers maximum UV filter (U6) as indicated under the Standard, and has a visible light transmission filter not more than 43% (i.e., it's tinted).

Under EN166 (last line, in blue), the visor offers UV filter (2); luminous transmittance between 43.2 and 29.1%; is made by MSA (MSA); offers the best optical quality (1) and medium energy impact resistance (B); offers resistance to high speed particles at temperature extremes (T); has passed molten metal/hot solid tests (9) and intensive tests for anti-scratch (K)/anti-fog (N).

## V-Gard Visors: General Purpose

|                               |  |
|-------------------------------|--|
| <b>Classification:</b>        | General purpose  |
| <b>Market(s):</b>             | General industry, manufacturing, repair and maintenance, construction, oil and gas, forestry, shipbuilding, metalworking, automotive, mining |
| <b>Application(s):</b>        | Chipping, splash, chiseling, drilling, grinding, machining, power fastening, sanding, sawing   |
| <b>Material:</b>              | Polycarbonate  |
| <b>Color(s):</b>              | Clear  |
| <b>Available Styles:</b>      | Contoured or flat; visors and nitrometers; bulk pack   |
| <b>Size:</b>                  | Varies; see "Product Specifics" in Ordering Information chart  |
| <b>Features:</b>              | Maximum UV protection ("U6")<br>Impact-rated (Z87+)  |
| <b>Standards<sup>1</sup>:</b> | ANSI/ISEA Z87.1-2010; EN 166 (2C-1.2 MSA 1B); CSA Z94.3; and AS/NZS 1337   |
| <b>Certification:</b>         | Third-party by Intertek, INSPEC International Ltd., CSA International and SAI Global Ltd.  |

## Ordering Information

| V-GARD VISORS FOR GENERAL PURPOSE APPLICATIONS                                      | Part No.  | Product Specifics  |
|---|---|--|
|    | 10115836<br>   | <ul style="list-style-type: none"> <li>8" (20.3 cm) x 17" (43.2 cm) x .04" (1.02mm)</li> <li>Contoured visor; closer fit and improved resistance to impact and splash hazards</li> </ul>   |
|   | 10115837<br> | <ul style="list-style-type: none"> <li>8" (20.3 cm) x 17" (43.2 cm) x .04" (1.02mm)</li> <li>Nitrometer; for use with V-Gard Retractable or Standard Chin Protectors</li> <li>Contoured visor; closer fit and improved resistance to impact and splash hazards</li> </ul>                    |
|  | 10120108<br> | <ul style="list-style-type: none"> <li>8" (20.3 cm) x 17" (43.2 cm) x .04" (1.02mm)</li> <li>Bulk pack of 20</li> <li>Contoured visor; closer fit and improved resistance to impact and splash hazards</li> </ul>  |
|  | 10117750  | <ul style="list-style-type: none"> <li>8" (20.3 cm) x 17" (43.2 cm) x .04" (1.02mm)</li> <li>Flat visor; wider design improved resistance to impact and splash hazards</li> <li>Does not meet CSA Z94.3</li> </ul>   |
|  | 10117781  | <ul style="list-style-type: none"> <li>8" (20.3 cm) x 17" (43.2 cm) x .04" (1.02mm)</li> <li>Flat nitrometer; for use with V-Gard Retractable or Standard Chin Protectors</li> <li>Wider design improved resistance to impact and splash hazards</li> <li>Does not meet CSA Z94.3</li> </ul> |
|  | 10115863<br> | <ul style="list-style-type: none"> <li>9.5" (24.1 cm) x 17" (43.2 cm) x .04" (1.02mm)</li> <li>Contoured visor; closer fit and improved resistance to impact and splash hazards</li> </ul>   |
|  | 10118094  | <ul style="list-style-type: none"> <li>9.5" (24.1 cm) x 17" (43.2 cm) x .04" (1.02mm)</li> <li>Flat visor; wider design improved resistance to impact and splash hazards</li> <li>Does not meet CSA Z94.3</li> </ul>   |









<sup>1</sup> Standards requirements met by each V-Gard Headgear/V-Gard Visor combination designated on each V-Gard Visor.



## V-Gard Visors: General Purpose with Anti-fog/Anti-scratch Coatings

|                               |  |
|-------------------------------|--|
| <b>Classification:</b>        | General purpose: humid conditions  |
| <b>Market(s):</b>             | General industry, manufacturing, repair and maintenance, construction, oil and gas, forestry, shipbuilding, metalworking, automotive, mining |
| <b>Application(s):</b>        | Hot/humid conditions, chipping, splash, chiseling, drilling, grinding, machining, power fastening, sanding, sawing                           |
| <b>Material:</b>              | Polycarbonate with anti-fog/anti-scratch coatings  |
| <b>Color(s):</b>              | Clear<br>Green tint  |
| <b>Available Styles:</b>      | Contoured; visors and nitrometers  |
| <b>Size:</b>                  | 8" (20.3 cm) x 17" (43.2 cm) x .06" (1.52mm)   |
| <b>Features:</b>              | Anti-fog/anti-scratch coatings<br>Impact-rated (Z87+)<br>Maximum UV protection ("U6")<br>Slightly thicker for industrial impact applications |
| <b>Standards<sup>1</sup>:</b> | ANSI/ISEA Z87.1-2010 and CSA Z94.3   |
| <b>Certification:</b>         | Third-party by Intertek and CSA International  |

## Ordering Information





| V-GARD VISORS FOR GENERAL PURPOSE APPLICATIONS                                      |  | Part No.  | Product Specifics  |
|---|--|---|--|
|   |  | 10115839<br> | <ul style="list-style-type: none"> <li>• Contoured visor; closer fit and improved resistance to impact and splash hazards</li> <li>• Clear</li> </ul>  |
|  |  | 10115841<br> | <ul style="list-style-type: none"> <li>• Nitrometer; for use with V-Gard Retractable or Standard Chin Protectors</li> <li>• Contoured visor; closer fit and improved resistance to impact and splash hazards</li> <li>• Clear</li> </ul>   |
|  |  | 10115842<br> | <ul style="list-style-type: none"> <li>• Contoured visor; closer fit and improved resistance to impact and splash hazards</li> <li>• Green tint, reduces glare; <b>not for use where a Shade infrared (IR) visor is required</b></li> </ul>  |
|  |  | 10115843<br> | <ul style="list-style-type: none"> <li>• Nitrometer; for use with V-Gard Retractable or Standard Chin Protectors</li> <li>• Contoured visor; closer fit and improved resistance to impact and splash hazards</li> <li>• Green tint, reduces glare; <b>not for use where a Shade infrared (IR) visor is required</b></li> </ul> |

<sup>1</sup> Standards requirements met by each V-Gard Headgear/V-Gard Visor combination designated on each V-Gard Visor.

## V-Gard Visors: General Purpose

|                               |  |
|-------------------------------|--|
| <b>Classification:</b>        | General purpose  |
| <b>Market(s):</b>             | General industry, manufacturing, repair and maintenance, construction, oil and gas, forestry, shipbuilding, metalworking, automotive, mining |
| <b>Application(s):</b>        | Chipping, splash, chiseling, drilling, grinding, machining, power fastening, sanding, sawing   |
| <b>Material:</b>              | Polycarbonate  |
| <b>Color(s):</b>              | Clear  |
| <b>Available Styles:</b>      | Contoured or flat; visors and nitrometers  |
| <b>Size:</b>                  | 8" (20.3 cm) x 17" (43.2 cm) x .06" (1.52mm)   |
| <b>Features:</b>              | Slightly thicker for industrial impact applications<br>Impact-rated (Z87+)<br>Maximum UV protection ("U6")                                   |
| <b>Standards<sup>1</sup>:</b> | ANSI/ISEA Z87.1-2010; EN 166 (2C-1.2 MSA 1B389); CSA Z94.3; and AS/NZS 1337  |
| <b>Certification:</b>         | Third-party by Intertek, INSPEC International Ltd., CSA International and SAI Global Ltd.  |

## Ordering Information



| V-GARD VISORS FOR GENERAL PURPOSE APPLICATIONS |   | Part No.  | Product Specifics  |
|--|---|---|--|
|  |    | 10115840<br> | • Contoured visor; closer fit and improved resistance to impact and splash hazards   |
|  |  | 10117782  | • Flat visor; wider design improved resistance to impact and splash hazards<br>• Does not meet CSA Z94.3   |
|  |  | 10117783  | • Flat nitrometer; for use with V-Gard Retractable or Standard Chin Protectors<br>• Wider design improved resistance to impact and splash hazards<br>• Does not meet CSA Z94.3 |

<sup>1</sup> Standards requirements met by each V-Gard Headgear/V-Gard Visor combination designated on each V-Gard Visor.

## V-Gard Visors: Heavy Duty with High-Performance Anti-fog/Anti-scratch Coatings

|                               |   |
|-------------------------------|---|
| <b>Classification:</b>        | General purpose: heavy duty, humid conditions   |
| <b>Market(s):</b>             | General industry, manufacturing, repair and maintenance, construction, oil and gas, forestry, shipbuilding, metalworking, automotive, mining  |
| <b>Application(s):</b>        | Hot/humid conditions, chipping, splash, chiseling, drilling, grinding, machining, power fastening, sanding, sawing, outdoor work  |
| <b>Material:</b>              | Polycarbonate, with EN-166 performance-rated anti-fog and anti-scratch coatings   |
| <b>Color(s):</b>              | Clear<br>Green tint   |
| <b>Available Styles:</b>      | Molded  |
| <b>Size:</b>                  | 10.375" (26.4 cm) x 17" (43.2 cm) x .098" (2.5 mm)  |
| <b>Features:</b>              | EN 166 performance-rated anti-fog/anti-scratch (N, K marks, respectively)<br>Impact-rated (Z87+)<br>Maximum UV protection ("U6")<br>Thick for heavy duty industrial impact applications |
| <b>Standards<sup>1</sup>:</b> | ANSI/ISEA Z87.1-2010; EN 166 (2C-1.2MSA 1BT389KN [clear] and 2.2MSA 1BT39KN [green]); CSA Z94.3; and AS/NZS 1337  |
| <b>Certification:</b>         | Third-party by Intertek, INSPEC International Ltd., CSA International and SAI Global Ltd.   |

### Ordering Information

| V-GARD VISORS FOR HEAVY DUTY GENERAL PURPOSE APPLICATIONS |   | Part No.  | Product Specifics   |
|---|---|---|---|
|   |  | 10115853<br> | <ul style="list-style-type: none"> <li>Molded visor for superior optics under heavy duty use</li> <li>Extended length for greater coverage of neck/face</li> <li>Performs well against many chemicals. Please refer to MSA's Chemical Application Quick Reference Guide (ID 0670-007/MC) for details</li> </ul> |
|   |  | 10115854<br> | <ul style="list-style-type: none"> <li>Molded visor for superior optics under heavy duty use</li> <li>Extended length for greater coverage of neck/face</li> <li>Green tint helps reduce glare; <b>not for use where a Shade IR visor is required</b></li> </ul>  |

<sup>1</sup> Standards requirements met by each V-Gard Headgear/V-Gard Visor combination designated on each V-Gard Visor.

## V-Gard Visors: General Purpose (Non-Impact)

|                               |  |
|-------------------------------|--|
| <b>Classification:</b>        | General purpose: non-impact  |
| <b>Market(s):</b>             | General industry, manufacturing, repair and maintenance, construction, oil and gas, forestry, shipbuilding, automotive, mining |
| <b>Application(s):</b>        | Flying chips and other light debris  |
| <b>Material:</b>              | Epoxy-coated steel mesh (20 x 20); plastic or aluminum-edged   |
| <b>Color(s):</b>              | Black<br>Aluminum  |
| <b>Available Styles:</b>      | Flat   |
| <b>Size:</b>                  | Varies; see "Product Specifics" in Ordering Information chart  |
| <b>Features:</b>              | General protector (Z87); <b>not for impact hazards</b>   |
| <b>Standards<sup>1</sup>:</b> | ANSI/ISEA Z87.1-2010; EN 1731-F; and AS/NZS 1337   |
| <b>Certification:</b>         | Third-party by Intertek, INSPEC International Ltd., and SAI Global Ltd.  |

### Ordering Information

| V-GARD VISORS<br>FOR GENERAL PURPOSE<br>APPLICATIONS |   | Part No. | Product Specifics   |
|--|---|----------|---|
|  |    | 10116557 | <ul style="list-style-type: none"> <li>• 8" (20.3 cm) x 17" (43.2 cm)</li> <li>• Visor; plastic-edged mesh</li> <li>• Not for use against splash, impact, elevated temperatures or UMV hazards</li> <li>• Can be worn with earmuffs</li> </ul>  |
|  |  | 10116558 | <ul style="list-style-type: none"> <li>• 8" (20.3 cm) x 17" (43.2 cm)</li> <li>• Nitrometer; for use with V-Gard Retractable or Standard Chin Protectors</li> <li>• Plastic-edged mesh</li> <li>• Not for use against splash, impact, elevated temperatures or UV hazards</li> <li>• Can be worn with earmuffs</li> </ul> |
|  |  | 10116556 | <ul style="list-style-type: none"> <li>• 8" (20.3 cm) x 16.5" (41.9 cm)</li> <li>• Aluminum-bound mesh</li> <li>• <b>Not for use against splash, impact, electrical or UV hazards</b></li> </ul>  |

<sup>1</sup> Standards requirements met by each V-Gard Headgear/V-Gard Visor combination designated on each V-Gard Visor.

## V-Gard Visors: Chemical and Splash

|                               |   |
|-------------------------------|---|
| <b>Classification:</b>        | Chemical and splash   |
| <b>Market(s):</b>             | General industry, heavy manufacturing, laboratories, chem/petrochemical, agriculture, pharmaceutical, oil and gas, mining   |
| <b>Application(s):</b>        | Chipping, splash, chemical mixing, grinding, machining, power fastening, sanding, sawing  |
| <b>Material:</b>              | Propionate  |
| <b>Color(s):</b>              | Clear   |
| <b>Available Styles:</b>      | Molded visor; molded nitrometer   |
| <b>Size:</b>                  | Varies; see "Product Specifics" in Ordering Information chart   |
| <b>Features:</b>              | Performs well against many types of chemicals. Please refer to MSA's Chemical Application Quick Reference Guide (ID 0670-007/MC) for details<br>Impact-rated (Z87+) |
| <b>Standards<sup>1</sup>:</b> | ANSI/ISEA Z87.1-2010; EN 166 (MSA 1B 3); CSA Z94.3; and AS/NZS 1337   |
| <b>Certification:</b>         | Third-party by Intertek, INSPEC International Ltd., CSA International and SAI Global Ltd.   |

## Ordering Information

| V-GARD VISORS FOR CHEMICAL AND SPLASH APPLICATIONS |   | Part No.  | Product Specifics  |
|--|---|---|--|
|  |   | 10115855<br>   | <ul style="list-style-type: none"> <li>• 8" (20.3 cm) x 17" (43.2 cm) x .098" (2.5mm)</li> <li>• Visor</li> <li>• Extra-thick to help prevent warping, cracking or crazing under tough conditions</li> </ul>   |
|  |  | 10115856<br> | <ul style="list-style-type: none"> <li>• 8" (20.3 cm) x 17" (43.2 cm) x .098" (2.5mm)</li> <li>• Nitrometer; for use with V-Gard Retractable or Standard Chin Protectors</li> <li>• Extra-thick to help prevent warping, cracking or crazing under tough conditions</li> </ul>             |
|  |  | 10115851<br> | <ul style="list-style-type: none"> <li>• 9.25" (23.5 cm) x 18" (45.7 cm) x .098" (2.5mm)</li> <li>• Visor</li> <li>• Extra-thick to help prevent warping, cracking or crazing under tough conditions</li> <li>• Extended length and width for greater coverage of neck and face</li> </ul> |

<sup>1</sup> Standards requirements met by each V-Gard Headgear/V-Gard Visor combination designated on each V-Gard Visor.

## V-Gard Visors: Chemical and Splash (Tinted)

|                               |   |
|-------------------------------|---|
| <b>Classification:</b>        | Chemical and splash   |
| <b>Market(s):</b>             | General industry, heavy manufacturing, laboratories, chem/petrochemical, agriculture, pharmaceutical, oil and gas, mining |
| <b>Application(s):</b>        | Outdoor use, chipping, splash, chemical mixing, grinding, machining, sanding, sawing                                      |
| <b>Material:</b>              | Propionate  |
| <b>Color(s):</b>              | Green tint  |
| <b>Available Styles:</b>      | Molded  |
| <b>Size:</b>                  | Varies; see "Product Specifics" in Ordering Information chart   |
| <b>Features:</b>              | Maximum UV protection ("U6")<br>Impact-rated (Z87+)<br>Green tint helps alleviate eyestrain and reduces glare             |
| <b>Standards<sup>1</sup>:</b> | ANSI/ISEA Z87.1-2010 and CSA Z94.3  |
| <b>Certification:</b>         | Third-party by Intertek and CSA International   |

### Ordering Information





| V-GARD VISORS FOR CHEMICAL AND SPLASH APPLICATIONS |   | Part No.  | Product Specifics  |
|--|---|---|--|
|  |   | 10115857<br>   | <ul style="list-style-type: none"> <li>• 8" (20.3 cm) x 17" (43.2 cm) x .098" (2.5mm)</li> <li>• Visor</li> <li>• Glare-reducing green tint alleviates eye strain and fatigue; <b>not for use where a Shade IR visor is required</b></li> <li>• Extra-thick to help prevent warping, cracking or crazing under tough conditions</li> </ul>   |
|  |  | 10115852<br> | <ul style="list-style-type: none"> <li>• 9.25" (23.5 cm) x 18" (45.7 cm) x .098" (2.5mm)</li> <li>• Visor</li> <li>• Glare-reducing green tint alleviates eye strain and fatigue; <b>not for use where a Shade IR visor is required</b></li> <li>• Extra-thick to help prevent warping, cracking or crazing under tough conditions</li> <li>• Extended length and width for greater coverage of neck and face</li> </ul> |

<sup>1</sup> Standards requirements met by each V-Gard Headgear/V-Gard Visor combination designated on each V-Gard Visor.

## V-Gard Visors: Elevated Temperature with High-Performance Anti-fog/Anti-scratch Coatings

|                               |  |
|-------------------------------|--|
| <b>Classification:</b>        | Elevated temperature   |
| <b>Market(s):</b>             | Food manufacturing/canneries, steel mills, construction, open-pit mining, agriculture, oil/gas/petrochemical refineries, rubber manufacturing, steam tunnels |
| <b>Application(s):</b>        | Food processing, machine operation, maintenance, millwright, cutting, punching, extrusion, drilling, blasting, casting/conveying, chemical mixing, sanding   |
| <b>Material:</b>              | Polycarbonate with EN166 performance-rated anti-fog and anti-scratch coatings  |
| <b>Color(s):</b>              | Clear  |
| <b>Available Styles:</b>      | Molded   |
| <b>Size:</b>                  | Varies; see "Product Specifics" in Ordering Information chart  |
| <b>Features:</b>              | EN166 performance-rated anti-fog/anti-scratch coatings (N, K marks, respectively)<br>Impact-rated (Z87+)<br>Maximum UV protection ("U6")                     |
| <b>Standards<sup>1</sup>:</b> | ANSI/ISEA Z87.1-2010; EN 166 (2C-1.2 MSA 1BT389KN); CSA Z94.3; and AS/NZS 1337   |
| <b>Certification:</b>         | Third-party by Intertek, INSPEC International Ltd., CSA International and SAI Global Ltd.  |

### Ordering Information

| V-GARD VISORS FOR ELEVATED TEMPERATURE APPLICATIONS                                 |   | Part No.   | Product Specifics   |
|---|---|--|---|
|   |               | 10115844<br>   | <ul style="list-style-type: none"> <li>• 9.25" (23.5 cm) x 17" (43.2 cm) x .098" (2.5mm)</li> <li>• Extra-thick visor helps prevent warping, cracking or crazing under tough conditions</li> <li>• Conditioned to a high of +131°F (and a low of -23°F) and then tested to the medium impact rating in the EN166 standard (higher impact speed than ANSI/ISEA Z87.1-2010)</li> <li>• <b>Visors do not reflect IR; not recommended for use against radiant heat hazards</b></li> </ul> |
|  | 10115846<br> | <ul style="list-style-type: none"> <li>• 9.25" (23.5 cm) x 18" (45.7 cm) x .098" (2.5mm)</li> <li>• Extra-thick visor helps prevent warping, cracking or crazing under tough conditions</li> <li>• Extended length for greater coverage of face and neck</li> <li>• Conditioned to a high of +131°F (and a low of -23°F) and then tested to the medium impact rating in the EN166 standard (higher impact speed than ANSI/ISEA Z87.1-2010)</li> <li>• <b>Visors do not reflect IR; not recommended for use against radiant heat hazards</b></li> </ul> |   |

<sup>1</sup> Standards requirements met by each V-Gard Headgear/V-Gard Visor combination designated on each V-Gard Visor.

## V-Gard Visors: Elevated Temperature (Tinted) with High-Performance Anti-fog/Anti-scratch Coatings

|                               |  |
|-------------------------------|--|
| <b>Classification:</b>        | Elevated temperature   |
| <b>Market(s):</b>             | Construction, open-pit mining, agriculture, oil/gas/petrochemical refineries   |
| <b>Application(s):</b>        | Food processing, machine operation, maintenance, millwright, cutting, punching, extrusion, drilling, blasting, casting/conveying, chemical mixing, sanding   |
| <b>Material:</b>              | Polycarbonate  |
| <b>Color(s):</b>              | Green tint   |
| <b>Available Styles:</b>      | Molded   |
| <b>Size:</b>                  | Varies; see "Product Specifics" in Ordering Information chart  |
| <b>Features:</b>              | EN166 performance-rated anti-fog/anti-scratch coatings (N, K marks, respectively)<br>Impact-rated (Z87+)<br>Green tint helps alleviate eyestrain and reduces glare<br>Maximum UV protection ("U6") |
| <b>Standards<sup>1</sup>:</b> | ANSI/ISEA Z87.1-2010; EN 166 (2.2 MSA 1BT39KN); CSA Z94.3; and AS/NZS 1337   |
| <b>Certification:</b>         | Third-party by Intertek, INSPEC International Ltd., CSA International and SAI Global Ltd.  |

### Ordering Information

| V-GARD VISORS FOR ELEVATED TEMPERATURE APPLICATIONS |   | Part No.  | Product Specifics   |
|---|---|---|---|
|   |   | 10115845<br>  | <ul style="list-style-type: none"> <li>• 9.25" (23.5 cm) x 17" (43.2 cm) x .098" (2.5mm)</li> <li>• Extra-thick visor helps prevent warping, cracking or crazing under tough conditions</li> <li>• Conditioned to a high of 131°F (and a low of 23°F) and then tested to the medium impact rating in the EN166 standard (higher impact speed than ANSI/ISEA Z87.1-2010)</li> <li>• <b>Visors do not reflect IR; not recommended for use against radiant heat hazards</b></li> <li>• <b>Not for use where a Shade IR visor is required</b></li> </ul>  |
|   |  | 10115849<br> | <ul style="list-style-type: none"> <li>• 9.25" (23.5 cm) x 18" (45.7 cm) x .098" (2.5mm)</li> <li>• Extra-thick visor helps prevent warping, cracking or crazing under tough conditions</li> <li>• Extended length for greater coverage of face and neck</li> <li>• Conditioned to a high of 131°F (and a low of 23°F) and then tested to the medium impact rating in the EN166 standard (higher impact speed than ANSI/ISEA Z87.1-2010)</li> <li>• <b>Visors do not reflect IR; not recommended for use against radiant heat hazards</b></li> <li>• <b>Not for use where a Shade IR visor is required</b></li> </ul> |

<sup>1</sup> Standards requirements met by each V-Gard Headgear/V-Gard Visor combination designated on each V-Gard Visor.



## V-Gard Visors: Radiant Heat/Elevated Temperature

|                               |  |
|-------------------------------|--|
| <b>Classification:</b>        | Radiant Heat/Elevated Temperature  |
| <b>Market(s):</b>             | Metal industries, glass manufacturing, iron and steel foundries, chemical manufacturing, construction, general manufacturing, textile manufacturing, mining, oil and gas |
| <b>Application(s):</b>        | Grinding, pouring, casting, blowing/melting, rolling, sawing, cutting, crimping, millwrighting, machining/operating, pipelining, pulping                                 |
| <b>Material:</b>              | Polycarbonate  |
| <b>Color(s):</b>              | Clear, reflective-coated<br>Green tint, reflective-coated  |
| <b>Available Styles:</b>      | Molded   |
| <b>Size:</b>                  | 9.5" (24.1 cm) x17.75" (45.09 cm) x .07" (1.8 mm)  |
| <b>Features:</b>              | Reflects >60% Infrared (IR) radiation (EN166 "R" mark)<br>Impact-rated (Z87+)<br>Maximum UV protection ("U6")  |
| <b>Standards<sup>1</sup>:</b> | ANSI/ISEA Z87.1-2010; EN 166 (2C-2.5 MSA 1BT3R) and (2-4 MSA 1BT3R), clear and green tint, respectively; CSA Z94.3; and AS/NZS 1337                                      |
| <b>Certification:</b>         | Third-party by Intertek, INSPEC International Ltd., CSA International and SAI Global Ltd.  |

### Ordering Information



| V-GARD VISORS FOR ELEVATED TEMPERATURE/RADIANT HEAT APPLICATIONS |   | Part No.  | Product Specifics  |
|--|---|---|--|
|  |   | 10115848<br> | <ul style="list-style-type: none"> <li>• Reflective coating reflects IR and helps dissipate heat</li> <li>• Thick visor helps prevent warping, cracking or crazing under tough conditions</li> <li>• Extended length for greater coverage of face and neck; <b>DO NOT use for welding</b></li> <li>• Clear, reflective-coated</li> </ul>   |
|  |  | 10115850<br> | <ul style="list-style-type: none"> <li>• Reflective coating reflects IR and helps dissipate heat</li> <li>• Green tint helps alleviate eyestrain and reduces glare; <b>not for use where a Shade IR visor is required</b></li> <li>• Thick visor helps prevent warping, cracking or crazing under tough conditions</li> <li>• Extended length for greater coverage of face and neck; <b>DO NOT use for welding</b></li> <li>• Green tint, reflective-coated</li> </ul> |

<sup>1</sup> Standards requirements met by each V-Gard Headgear/V-Gard Visor combination designated on each V-Gard Visor.

## V-Gard Visors: Welding (Shades 3 and 5)

|                               |  |
|-------------------------------|--|
| <b>Classification:</b>        | Welding  |
| <b>Market(s):</b>             | Fabrication, steel mills, shipbuilding, construction, open-pit mining, agriculture, oil/gas/petrochemical refineries, rubber manufacturing |
| <b>Application(s):</b>        | Welding, metal pouring, gas soldering, light cutting/brazing, manufacturing, impact and debris   |
| <b>Material:</b>              | Polycarbonate  |
| <b>Color(s):</b>              | Shade 3 IR, green<br>Shade 5 IR, green   |
| <b>Available Styles:</b>      | Molded or Nitrometer   |
| <b>Size:</b>                  | 8" (20.3 cm) x 17" (43.2 cm) x .07" (1.8 mm)   |
| <b>Features:</b>              | Protection from IR, up to Shade 3 or Shade 5, as applicable<br>Impact-rated (Z87+)   |
| <b>Standards<sup>1</sup>:</b> | ANSI/ISEA Z87.1-2010; EN 166 (4-3/3 MSA 1BT39 [shade 3] and 4-5/5 MSA 1BT39 [shade 5]); CSA Z94.3; and AS/NZS 1337                         |
| <b>Certification:</b>         | Third-party by Intertek, INSPEC International Ltd., CSA International and SAI Global Ltd.  |



### Ordering Information

| V-GARD VISORS FOR WELDING APPLICATIONS |   | Part No.  | Product Specifics  |
|--|---|---|--|
|  |   | 10115859<br>   | <ul style="list-style-type: none"> <li>• Shade 3 IR</li> <li>• Visor</li> <li>• Thickness helps prevent pitting and warping from heat or weld spatter</li> </ul>   |
|  |  | 10115860<br> | <ul style="list-style-type: none"> <li>• Shade 3 IR</li> <li>• Nitrometer; for use with V-Gard Retractable or Standard Chin Protectors</li> <li>• Thickness helps prevent pitting and warping from heat or weld spatter</li> </ul> |
|  |  | 10115861<br> | <ul style="list-style-type: none"> <li>• Shade 5 IR</li> <li>• Visor</li> <li>• Thickness helps prevent pitting and warping from heat or weld spatter</li> </ul>   |
|  |  | 10115862<br> | <ul style="list-style-type: none"> <li>• Shade 5 IR</li> <li>• Nitrometer; for use with V-Gard Retractable or Standard Chin Protectors</li> <li>• Thickness helps prevent pitting and warping from heat or weld spatter</li> </ul> |

<sup>1</sup> Standards requirements met by each V-Gard Headgear/V-Gard Visor combination designated on each V-Gard Visor.

## V-Gard Headgear Kits

V-Gard Headgear Kits offer simple and complete solutions for many general purpose and elevated temperature applications where face protection ONLY is needed.



|   |   |   |
|---|---|---|
|  | <p>P/N 10127063<br/>V-GARD HEADGEAR KIT,<br/>GENERAL PURPOSE</p>      | <p><b>Contains:</b></p> <ul style="list-style-type: none"> <li>• V-Gard General Purpose Headgear (PN 10127061)</li> <li>• V-Gard Clear, PC Visor, 8" (20.3 cm) x 17" (43.2 cm) x .04" (1.02 mm) (PN 10115836)</li> </ul>  |
|  | <p>P/N 10127064<br/>V-GARD HEADGEAR KIT,<br/>ELEVATED TEMPERATURE</p> | <p><b>Contains:</b></p> <ul style="list-style-type: none"> <li>• V-Gard Headgear, Elevated Temperature, Extended (PN 10127062)</li> <li>• V-Gard Clear, Green tint PC, reflective coating, molded, 9.5" (24.1 cm) x 17.75" (45.09 cm) x .07" (1.78 mm) (PN 10115850)</li> </ul> |

## V-Gard Headgear Replacement Sweatband<sup>1</sup>

|   |   |  |
|---|---|--|
|  | <p>P/N 10127065<br/>V-GARD HEADGEAR<br/>REPLACEMENT SWEATBAND</p> | <ul style="list-style-type: none"> <li>• Sweat-wicking material over breathable foam helps keep workers cool, dry and comfortable.</li> <li>• Hook &amp; loop closure makes replacement easy!</li> <li>• Tested to the FR requirements in CSA Z94.3-07.</li> <li>• Sold in bags of 5.</li> </ul> |
|---|---|--|

## V-Gard Chin Protectors<sup>2</sup>

V-Gard Chin Protectors work with select V-Gard Nitrometers to help provide extra protection from impact and splash hazards to face and neck.

|   |  |  |
|---|--|--|
|  | <p>P/N 10115828<br/>RETRACTABLE CHIN PROTECTOR</p> | <ul style="list-style-type: none"> <li>• 3.82" (9.7 cm) in height, when unretracted.</li> <li>• Unique retractable plates allow greater flexibility of head movement both up and down, as well as side to side.</li> <li>• Opaque material ensures safety and standards compliance with clear, tinted, shaded and coated V-Gard Visors.</li> </ul> |
|  | <p>P/N 10115827<br/>STANDARD CHIN PROTECTOR</p>    | <ul style="list-style-type: none"> <li>• 2.86" (7.26 cm) in height.</li> <li>• Opaque material ensures safety and standards compliance with clear, tinted, shaded and coated V-Gard Visors.</li> <li>• Compact, lightweight design provides additional protection between chin and neck area.</li> </ul>   |

<sup>1</sup> Use only genuine MSA V-Gard Accessory System replacement parts to help ensure compatibility and compliance. MSA does not warrant, guarantee or promote the use of components manufactured by other companies when used in conjunction with MSA products.

<sup>2</sup> MSA V-Gard Chin Protectors meet the applicable safety requirements as noted on V-Gard Nitrometers when worn in conjunction with V-Gard Headgear or Frames and V-Gard Nitrometers.

For more information visit [www.MSAafety.com](http://www.MSAafety.com) Keyword: VGardHeadgear  
or call Customer Service 1.800.MSA.2222



**Note:** This bulletin contains only a general description of the products shown. While uses and performance capabilities are described, under no circumstances shall the products be used by untrained or unqualified individuals and not until the product instructions including any warnings or cautions provided have been thoroughly read and understood. Only they contain the complete and detailed information concerning proper use and care of these products.



**ID 0300-10-MC / May 2013**

© MSA 2013 Printed in U.S.A.

**Corporate Center**  
1000 Cranberry Woods Drive,  
Cranberry Township, PA 16066 USA  
Phone 724-776-8600  
[www.MSAafety.com](http://www.MSAafety.com)

**U.S. Customer Service Center**  
Phone 1-800-MSA-2222  
Fax 1-800-967-0398

**MSA Canada**  
Phone 1-800-672-2222  
Fax 1-800-967-0398

**MSA Mexico**  
Phone 01 800 672 7222  
Fax 52-44 2227 3943

**MSA International**  
Phone 724-776-8626  
Toll Free: 1-800-672-7777  
FAX 724-741-1559

