



General Monitors

by MSA

MODEL SB100

Ultrasonic Bump Tester for
Ultrasonic Gas Leak Detectors



The information and technical data disclosed in this document may be used and disseminated only for the purposes and to the extent specifically authorized in writing by General Monitors.

Instruction Manual

03-16

General Monitors reserves the right to change published specifications and designs without prior notice.



Part No.
Revision

MANSB100
B/03-16



The Safety Company

General Monitors Ireland
Ballybrit Business Park
Galway, Ireland
Phone: +353-91-751175

www.MSAafety.com/detection



DECLARATION OF CONFORMITY

We, at General Monitors Ireland Ltd., hereby declare that the equipment described below, both in its basic design and construction, and in the version or versions marketed by us, conforms to the relevant safety and health related requirements of the appropriate EC Directives, only as follows:

Model: SB100 Ultrasonic Bump Tester

- a) Conforms to the protection requirements of EMC Directive 2004/108/EC.
Report Number D21128Q3 (Dated 12/12) by Compatible Electronics, 20621 Pascal Way, Lake Forest, CA 92630.

Relevant Standards:
EN 61000-6-2:2005
EN 61000-6-4: 2007/A1:2011

- b) Sira Certification Service, Unit 6 Hawarden Industrial Park, Hawarden, CH5 3US, United Kingdom, notified body number 0518 in accordance with Article 9 of Directive 94/9/EC of 23 March 1994, certifies that this equipment has been found to comply with the Essential Health and Safety Requirements relating to the design and construction of equipment intended for use in potentially explosive atmospheres given in Annex II to the Directive. Certificate No. SIRA 14ATEX1328X.

Relevant Standards:
EN 60079-0: 2012
EN 60079-1: 2007
EN 60079-11:2012
EN 60079-31: 2014



II 2 G D
Ex d Ia IIB+H₂ T4 Gb
Ex ia tb IIIC T135°C Db

It is ensured through internal measures, our ISO 9001:2008 and PQAN certifications as issued by Sira Certification, Notified Body 0518 that series production units conform at all times to the requirements of these current EC Directives and relevant standards.

The CE marking on the products and/or their packaging signifies that General Monitors holds the reference technical file available to the European Union authorities.

Responsible Person:

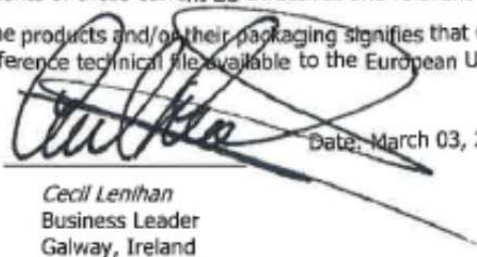
Cecil Lenihan
Business Leader
Galway, Ireland

Date: March 03, 2016

The signatory acts on behalf of company management, and with full power of attorney.



General Monitors

by MSA

Table of Contents

About This Manual	1
1.0 Introduction.....	2
1.1 Notice	2
1.2 Special Warnings	2
1.3 Description	3
1.4 Upon Receiving	3
1.5 Ultrasonic Tester Operating Principle	3
2.0 Use and Operation.....	4
3.0 Ultrasonic Tester Components	6
3.1 Ultrasonic Transducer.....	6
3.2 Rechargeable Battery	6
3.3 Charger Jack	6
3.4 On-Off Button.....	7
3.5 Aluminum Case and Front Cover	7
3.6 Battery Charger.....	7
3.7 Shoulder Strap.....	7
4.0 Maintenance and Warranty	8
4.1 Maintenance.....	8
4.2 Recharging the Battery	8
4.3 Obtaining Service.....	9
4.4 Warranty.....	9
5.0 Troubleshooting Guide.....	10
6.0 Customer Support	11
7.0 Appendix	12
7.1 Specifications	12

Table of Figures

Figure 1: Model SB100 Ultrasonic Bump Tester	2
Figure 2: Approximate distance between SB100 and the Ultrasonic Gas Leak Detector is 4-18 meters.	4
Figure 3: SB100 Components.....	6

Table of Tables

Table 1: Charge State Indicator.....	7
Table 2: Troubleshooting Table	10
Table 3: Locations	11
Table 4: MSA Customer Support.....	11

About This Manual

This manual provides instructions for operating, and maintaining the Model SB100 Ultrasonic Bump Tester manufactured by General Monitors, an MSA Company. The intended audience includes installation personnel, field service technicians, and other technical staff involved in using a SB100.

Format Conventions

Several format conventions are used throughout this manual for Notes, Cautions and Warnings. These conventions are described below.

Notes, Cautions, and Warnings

NOTE: Notes provide supplementary details such as exception conditions, alternate methods for a task, time saving tips, and references to related information.



CAUTION: These notices describe precautions to prevent hazardous conditions that may damage the equipment.



WARNING: These notices describe precautions to prevent hazardous conditions that may cause injury to people working with the equipment.

Contacting Customer Support

For additional product information not contained in this manual, please contact our Customer Support group. Refer to Section 6.0 for contact information.

1.0 Introduction



Figure 1: Model SB100 Ultrasonic Bump Tester

1.1 Notice

All information contained in this instruction manual applies only to the setup and operation of the Model SB100 Ultrasonic Bump Tester with ultrasonic gas leak detectors provided by MSA and General Monitors. The sale of the Ultrasonic Tester does not license the user to reproduce drawings or to utilize any information contained in this manual without prior written permission.

The SB100 Ultrasonic Bump Tester is easy to set up and operate. However, this manual should be read in full, and the information contained herein understood, before attempting to operate the Ultrasonic Tester in service.

1.2 Special Warnings



WARNING: Do not leave battery uncharged. It will result in permanent battery damage.



WARNING: High ultrasonic energy is injurious to one's hearing. Do not stare into functioning tester. Wear ultrasonic blocking ear protection to prevent hearing injury.



WARNING: DO NOT OPEN OR CHARGE IN HAZARDOUS AREA. READ AND UNDERSTAND INSTRUCTION MANUAL BEFORE OPERATION OR SERVICING. KEEP COVER TIGHT WHILE CIRCUITS ARE LIVE. POTENTIAL ELECTROSTATIC CHARGING HAZARD - SEE INSTRUCTIONS. SUBSTITUTION OF COMPONENTS MAY IMPAIR INTRINSIC SAFETY. ENSURE CHARGER PORT PLUG IS TIGHTENED TO 32.5Nm.



AVERTISSEMENT: NE PAS OUVRIR OU CHARGER DANS L'ENDROIT HASARDEUX. LIRE ET COMPRENDRE MANUEL D'INSTRUCTIONS AVANT D'UTILISER OU SERVICE. GARDER LE COUVERCLE BIEN FERMÉ TANT QUE LES CIRCUITS SONT SOUS TENSION. POTENTIEL CHARGE ÉLECTROSTATIQUE DANGER - VOIR INSTRUCTIONS. LA SUBSTITUTION DE COMPOSANTS PEUT COMPROMETTRE LA SÉCURITÉ INTRINSÈQUE. ASSURER CHARGEUR PORT PLUG EST RESSERRÉE POUR 32.5Nm.

1.3 Description

The Model SB100 is a battery operated rechargeable Ultrasonic Tester specifically designed to test Ultrasonic Gas Leak Detectors (UGLD). The Ultrasonic Tester provides a high-energy, ultrasonic radiation source that emits sufficient ultrasonic energy to activate General Monitors Detectors.

1.4 Upon Receiving

The SB100 Ultrasonic Bump Tester leaves the factory with the battery charged and connected. The customer must **fully** charge the battery before use.

1.5 Ultrasonic Tester Operating Principle

The Ultrasonic Tester is used to check the operation of General Monitors Ultrasonic Gas Leak Detectors. When the Ultrasonic Tester is activated it generates a narrow beam of high ultrasonic energy which triggers the alarm or test mode of the detectors. The specific spectrum of the tester makes it possible to be recognized by smart detectors to enter test modes rather than trigger alarms. Please refer to the Instruction Manual of the General Monitors Detector (Observer-i and later) for details on its operation. The Model SB100 is useful for quick tests where physical access to the detector can be difficult. For more complete test and calibration of General Monitors UGLDs, the General Monitors Model 1701 Portable Test and Calibration Unit should be used. The use of the SB100 does not replace real leak simulation by means of inert gas like nitrogen.

2.0 Use and Operation

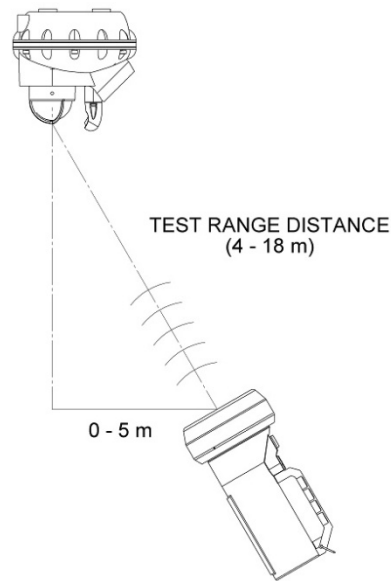

Figure 2: Approximate distance between SB100 and the Ultrasonic Gas Leak Detector is 4-18 meters.

It is important to begin a series of detector checks with a fully charged SB100.

- Stand 0 to 5 meters from the vertical axis of the General Monitors Detector to be tested and aim the SB100 directly at the detector's sensor. The acoustic path needs to be clear of any objects that may interfere with sound propagation. Do not place anything against the front cover of the tester as this may block ultrasonic energy.
- Press the ON button and confirm the audible monitoring sound is present.
- When the Detector senses the Ultrasonic Tester it may trigger the alarm or enter a test mode. Please refer to the Ultrasonic Gas Leak Detector Instruction Manual for details.

Model SB100 Range Testing	
Test Range Distance	Average Sound Level Reading +/-5 dB
4 m (13 ft)	88
6 m (20 ft)	82
8 m (26 ft)	78
10 m (33 ft)	74
12 m (39 ft)	70
14 m (46 ft)	68
16 m (52 ft)	64
18 m (59 ft)	60



WARNING: High ultrasonic energy is injurious to one's hearing. Do not stare into functioning tester. Wear ultrasonic blocking ear protection to prevent hearing injury.

NOTE: The SB100 may trigger certain Ultrasonic Gas Leak Detectors into alarm. For this situation the system must be disabled while testing to prevent false trips.

When the battery level drops below the level required for maintaining the proper intensity of the ultrasonic energy, the blue LED on the ON button will blink slowly. In this situation the tester is still functional but the ultrasonic output level is not optimal until the battery is recharged.

NOTE: Please refer to Section 3.6 for Battery Charge State Indicator details.

NOTE: Please refer to Section 4.2 for detailed information on Recharging the Battery. The normal recharge time for the rechargeable battery is 3.5 hours.

3.0 Ultrasonic Tester Components

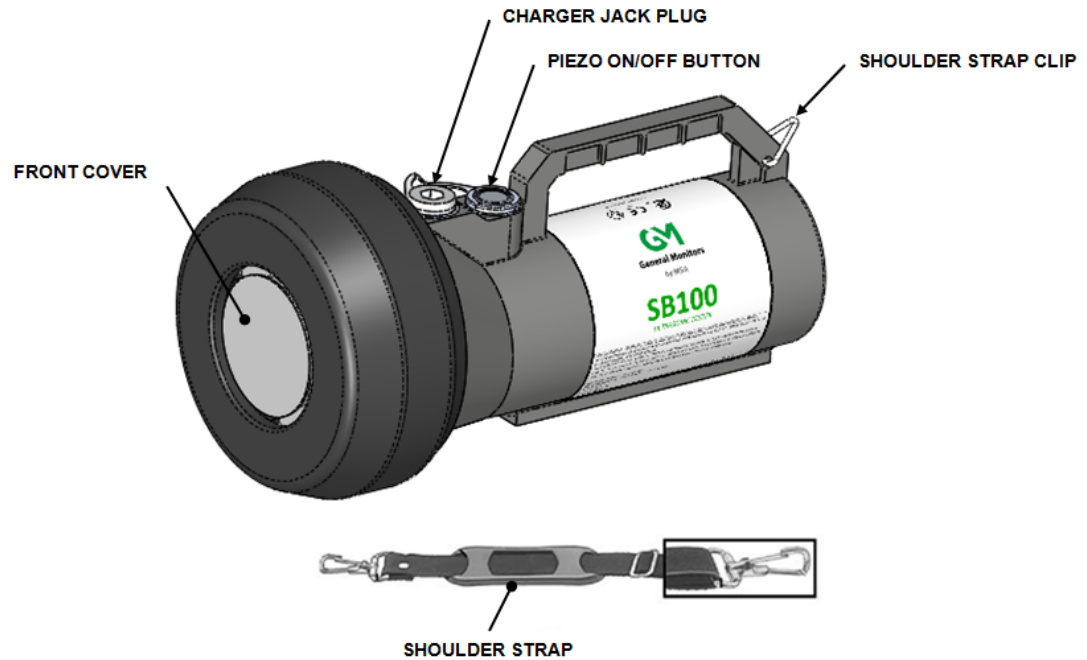

Figure 3: SB100 Components

3.1 Ultrasonic Transducer

The ultrasonic transducer generates high ultrasonic energy from the face of the front cover when the unit is activated. Any interference with this part will degrade the integrity of the Ultrasonic Tester's output signal.

3.2 Rechargeable Battery

The SB100 Ultrasonic Tester is powered by a 12 V rechargeable battery. It is recommended to keep the SB100 docked with its battery charger when it is not being used. This will increase the expected life of the battery and keep the Ultrasonic Tester ready for immediate use.

NOTE: The normal recharge time for the rechargeable battery is 3.5 hours.

3.3 Charger Jack

The charger jack is located directly under the aluminum plug and can be accessed when the plug is removed. The plug must always be in place when operated in a hazardous location and tightened to 32.5 Nm. An Allen wrench is included with the SB100 to unscrew or affix the plug. With the plug removed, the battery can be recharged by connecting the jack to the SB100 battery charger. The battery charger operates from a 110 – 240 VAC power line.

3.4 On-Off Button

The On-Off button is a piezo type without movable parts. It toggles the tester ON or OFF. Press the button once to turn the tester on, and press it again to turn the instrument off. The tester stays ON for a maximum of 90 seconds. After that, the tester will turn itself off. This is to prevent the battery becoming completely discharged if the ON / OFF button is accidentally bumped against.

3.5 Aluminum Case and Front Cover

The SB100 aluminum case housing, including the front cover, is explosion proof for use in hazardous locations. It can also be used for general-purpose, non- hazardous applications.

3.6 Battery Charger

The SB100 Ultrasonic Tester is supplied with a NiMH Battery External Charger P/N 940-407. The bi-color LED affixed to the external NiMH Charger, supplied with the tester, displays the charge state of the battery. The flashing patterns and colors of the signals are shown in Table 1.













MODE	DESCRIPTION	LED INDICATION
Standby	Yellow Permanent On	Yellow  Green
Pre-Charge	Yellow Slow Flashing	Yellow   Green
Waiting to Valid Temperature	Yellow & Green Alternating	Yellow   Green  
Rapid Charge	Green Fast Flashing	Yellow Green 
Maintenance Charge	Green Slow Flashing	Yellow Green  
Ready	Green Permanent On	Yellow Green 
Error	Yellow Fast Flashing	Yellow  Green

Table 1: Charge State Indicator

NOTE: Care must be used to ensure the proper charger and battery pack are used. Only General Monitors supplied battery packs and chargers may be used.

3.7 Shoulder Strap

The SB100 Ultrasonic Tester is provided with a shoulder strap to facilitate the transportation of the device by the operators. The shoulder strap is removable and can be attached to the SB100 using the clip installed on the unit's handle.

4.0 Maintenance and Warranty

4.1 Maintenance

Routine maintenance for the SB100 Ultrasonic Tester is minimal:

- When the Ultrasonic Tester is not being used, it is recommended to ensure that the Ultrasonic Tester is docked on the charger and the charger is connected to a live 110 – 240 VAC power outlet. Due to the self-discharge process typical of NiMH batteries, permanent battery damage may occur if not charged for 90 days.
- The battery life will be affected by extreme temperatures. Although certified for storage from -20°C to +60°C (-4°F to +140°F), store and charge the battery between +5°C and +30°C (+41°F and +86°F) if possible to prolong battery life

There are no user serviceable parts inside the SB100. After a number of years, the battery may fail. This will be indicated by an Orange/Yellow toggle LED at the external charger. The unit should be returned to the manufacturer for a replacement battery. If the Ultrasonic Tester is to be discarded, the battery must be recycled at this point.



In most countries it is illegal to dispose of the battery with other garbage. General Monitors has a Recycle Program in place to recycle the used batteries.

4.2 Recharging the Battery

Before the tester is used for the first time, or after it has been used to the point when the blue LED starts blinking slowly, the battery must be recharged. To recharge the battery, take the Ultrasonic Tester to a non-hazardous area where there is no possibility of an explosive gas or dust atmosphere being present. The temperature in this area must be between 32°F (0°C) and 104°F (40°C). No damage will occur if the unit is outside the temperature range, but the battery will not charge.

Use an Allen wrench to remove the charging plug stopper and connect the NiMH Battery External Charger P/N 940-407 to the charging socket exposed by removing the charging stopper.

Plug the NiMH Battery External Charger into an electrical outlet 110 – 240 VAC, 50 to 60 Hz rated to provide at least 0.8 A. Refer to Table 1 for the description of the charge indication. If the tester is to be stored, leave it connected to the NiMH Battery External Charger to keep the battery charged. The batteries may be charged an average of 500 times before the battery pack needs to be replaced

Before using the Ultrasonic Tester, unplug the charging connector from the Ultrasonic Tester, carefully insert the charging plug stopper using an Allen wrench and tighten it to 32.5 Nm. The tester can now be safely used in hazardous locations as specified on the SB100 nameplate and in Section 7.1 of this manual.

4.3 Obtaining Service

The Model SB100 Ultrasonic Bump Tester contains no user serviceable parts. To obtain information regarding factory service, contact the manufacturer or your manufacturer's representative. Please have the following information available:

- Instrument model number (on the nameplate)
- Instrument serial number (on the nameplate)
- Description of the problem

4.4 Warranty



CAUTION: There are no user serviceable parts inside the SB100 Ultrasonic Tester. Work performed by persons not authorized by the manufacturer will void the warranty.

General Monitors, an MSA company, warrants the Model SB100 Ultrasonic Tester and the accessory battery charger to be free from defects in workmanship or material under normal use and service within two (2) years from the date of shipment.

General Monitors will repair or replace without charge any equipment found to be defective during the warranty period. Full determination of the nature of, and responsibility for, defective or damaged equipment will be made by General Monitors' personnel.

Defective or damaged equipment must be shipped prepaid to General Monitors or the representative from which shipment was made. In all cases, this warranty is limited to the cost of the equipment supplied by General Monitors. The customer will assume all liability for the misuse of this equipment by its employees or other personnel.

All warranties are contingent upon proper use in the application for which the product was intended and do not cover products which have been modified or repaired without General Monitors' approval or which have been subjected to neglect, accident, improper installation or application, or on which the original identification marks have been removed or altered.

Except for the express warranty stated above, General Monitors disclaims all warranties with regard to the products sold, including all implied warranties of merchantability and fitness and the express warranties stated herein are in lieu of all obligations or liabilities on the part of General Monitors for damages including, but not limited to, consequential damages arising out of / or in connection with the use or performance of the product.

5.0 Troubleshooting Guide

The following table lists potential problems that can affect the Ultrasonic Tester circuit. Follow the individual steps to pinpoint and define circuit ailments.

This section is intended to be a guide in correcting problems, which may arise in the field. The manufacturer should be contacted for assistance if the corrective action listed does not eliminate the problem.

Condition	Possible Solution
Ultrasonic Tester does not turn ON.	<ol style="list-style-type: none"> 1. Remove the external charger plug if it is installed. 2. Battery may require a recharge. 3. Ensure the environmental temperature is not greater than 55°C.
When Ultrasonic Tester is turned on the blue LED lights but the audible monitor is not active.	<ol style="list-style-type: none"> 1. Remove the external charger plug if it is installed. 2. The Ultrasonic Tester must be returned for service.
During charging, the charge indicator LED on the external charger of the unit is Yellow flashing fast.	The Ultrasonic Tester and the charger must be returned for service.
Ultrasonic Tester stops after 90 seconds of use.	This is an intentional part of the design to prevent the tester draining the battery if the on/off button is knocked. Press the on/off button again and the tester will resume working.
During operation the blue LED on the ON/OFF button flashes slowly.	The battery has been discharged. Recharge the battery, in a non- hazardous location, using the battery charger.
During operation the blue LED on the ON/OFF button flashes rapidly.	The Ultrasonic Tester must be returned for service.

Table 2: Troubleshooting Table

6.0 Customer Support

Area	Phone / Email
UNITED STATES	
26776 Simpatica Circle Lake Forest, CA 92630	Phone: +1-949-581-4464. 800-446-4872 Email: info.gm@MSAsafety.com
9776 Whithorn Drive Houston, TX 77095	Phone: +1-281-855-6000
UNITED KINGDOM	
Heather Close Lyme Green Business Park Macclesfield, Cheshire, United Kingdom, SK11 0LR	Phone: +44-1625-619-583
IRELAND *	
Ballybrit Business Park Galway Republic of Ireland, H91 H6P2	Phone: +353-91-751175 Email: info.gmil@MSAsafety.com
SINGAPORE	
Block 5, Amk Tech II, #05-20/22/23 Ang Mo Kio Industrial Park 2A Singapore 567760	Phone: +65-6748-3488
MIDDLE EAST	
PO Box 54910 Dubai Airport Free Zone United Arab Emirates	Phone: +971-4294 3640

Table 3: Locations

** Model SB100 is manufactured at this location.*

Area	Phone/Email
United States/International	
MSA Corporate Center: 1000 Cranberry Woods Drive Cranberry Township, PA 16066 USA	Toll Free: +1-877-672-3473 Phone: +1-724-776-8600 Email: info@MSAsafety.com Email: msa.international@MSAsafety.com
EUROPE	
Thiemannstrasse-1 12059 Berlin, Germany	Phone: +49-(0)30 68 86-0 Email: info.de@MSAsafety.com

Table 4: MSA Customer Support

Additional locations can be found on our web site, www.MSAsafety.com

7.0 Appendix

7.1 Specifications

System Specifications	
Detectors Tested	Observer-i, Observer-H, Surveyor, UltraSonic EX-5, IS-5
Test Activation Distance	4-18 meters (13-59 feet)
Acoustic Output Tolerance	±5 dB
Angle of Regard	±5° relative to facing detector
Approvals Classification	ATEX/IECEX/CSA: Ex d ia IIB+H ₂ T4 Gb, Ex ia tb IIIC T135°C Db (Ta = -20°C to +50°C) CSA: Class I, Div. 1, Groups B,C,D; Class II, Groups E,F,G; Class III, T4 (Ta = -20°C to +50°C)
Approvals	CSA, ATEX, IECEX, CE
Accessories	Battery Charger, Shoulder Strap
Electrical Specifications	
Input Voltage	12 VDC, 10 W max
Charger Input Voltage	110 – 240 VAC, 50/60 Hz @ 0.8 A max.
Charger Output Voltage	14.4 VDC max @ 1.6 A
Charging Time	3.5 h max
EMC	EN 61000-6-2, EN 61000-6-4
Environmental Specifications	
Operating Temperature	-20°C to +50°C (-4°F to +122°F)
Storage Temperature	-20°C to +60°C (-4°F to +140°F)
Charging Temperature	0°C to 40°C (32°F to 104°F)
Operating Humidity	0-95% RH, non-condensing
Mechanical Specifications	
Housing	Aluminum
Dimensions	305 mm L x 152 mm D (12 in L x 6 in D)
Weight	3.8 kg (8.4 lbs)
Ingress Protection	IP66, Type 4X
Warranty	Two Years
Part Number	SB100-1000



ADDENDUM

This product may contain hazardous and/or toxic substances.

EU Member states shall dispose according to WEEE regulations. For further WEEE disposal information please visit: www.MSAafety.com

All other countries or states: please dispose of in accordance with existing federal, state and local environmental control regulations.