

BMR Low Pressure

PARTS LIST

Certified Maintenance



Be Sure.
Choose MSA.

MINE SAFETY APPLIANCES COMPANY
PITTSBURGH, PENNSYLVANIA, U.S.A. 15230

KEY

AIR MASK PARTS OUTLINED MAY
ONLY BE PURCHASED BY TRAINED,
CERTIFIED REPAIRMEN WITH A
REGULATOR TESTER

▲ NOTE: THE REGULATOR ASSEMBLY NO. DOES NOT
INCLUDE ELBOWS, HIGH PRESSURE HOSE AND
AUDI-LARM

- ★ 604070 LUBRICANT
- USE LOCTITE 222 WHEN ASSEMBLING
(MSA SEALANT P/N 29787)
- * USE LOCTITE 290 WHEN ASSEMBLING
(MSA SEALANT P/N 6000469)

Pressure Demand Regulator

Prior Design
part number 484916

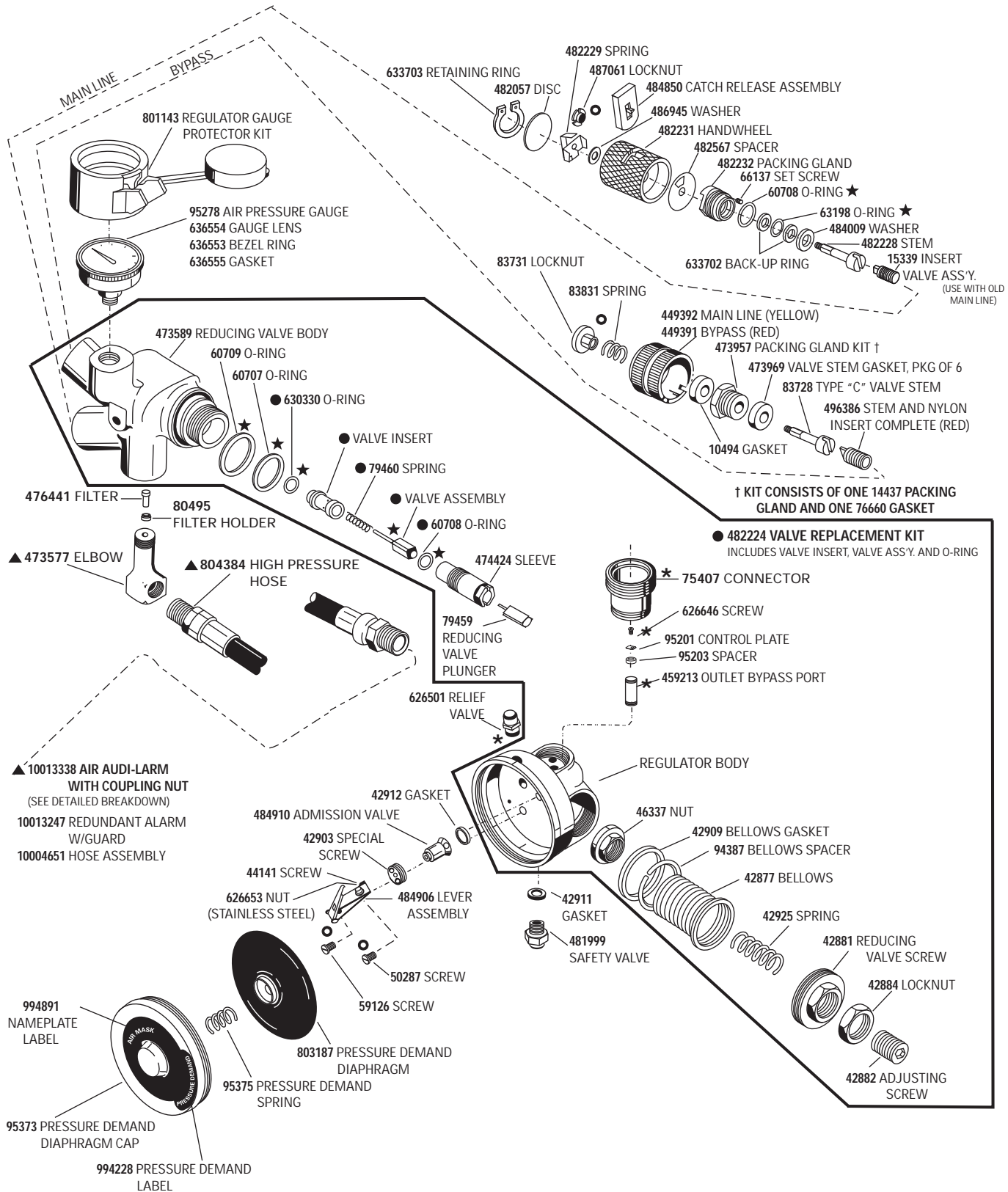

Pressure Demand Regulator

Current Design
part number 803146

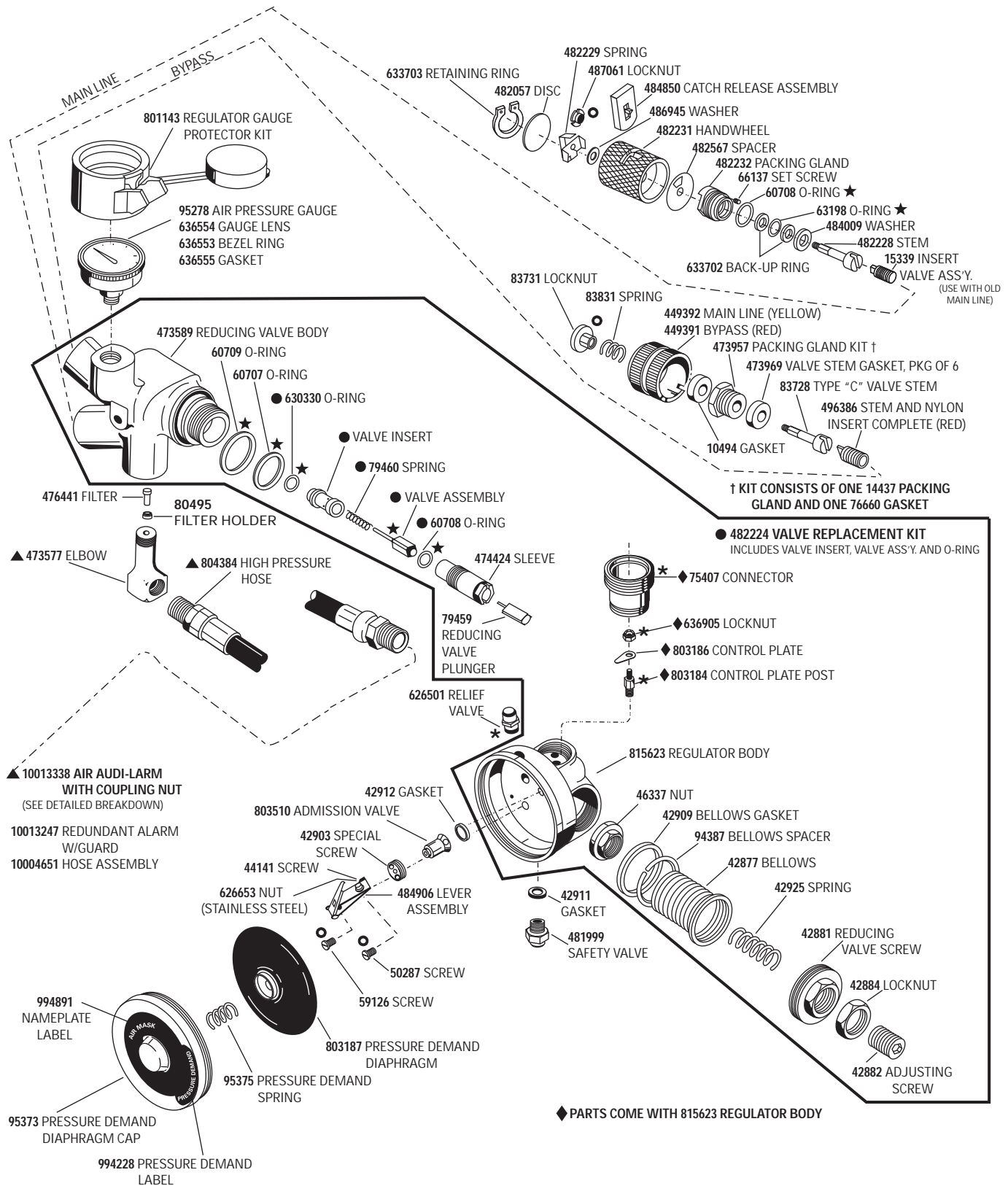

Quick-Fill Fitting Assembly

part number 473577

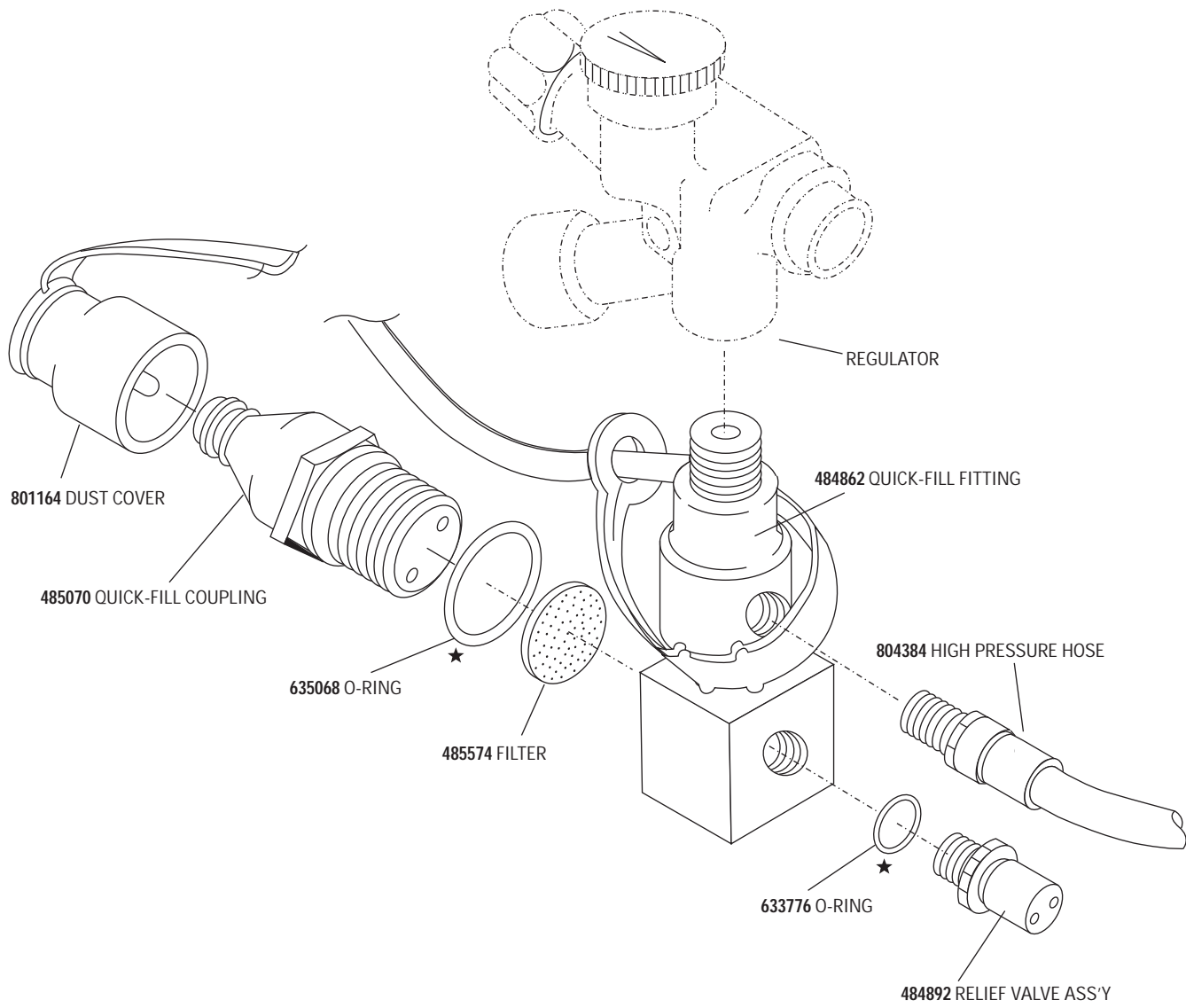

Audi-Larm™ Assembly

part number 10013338

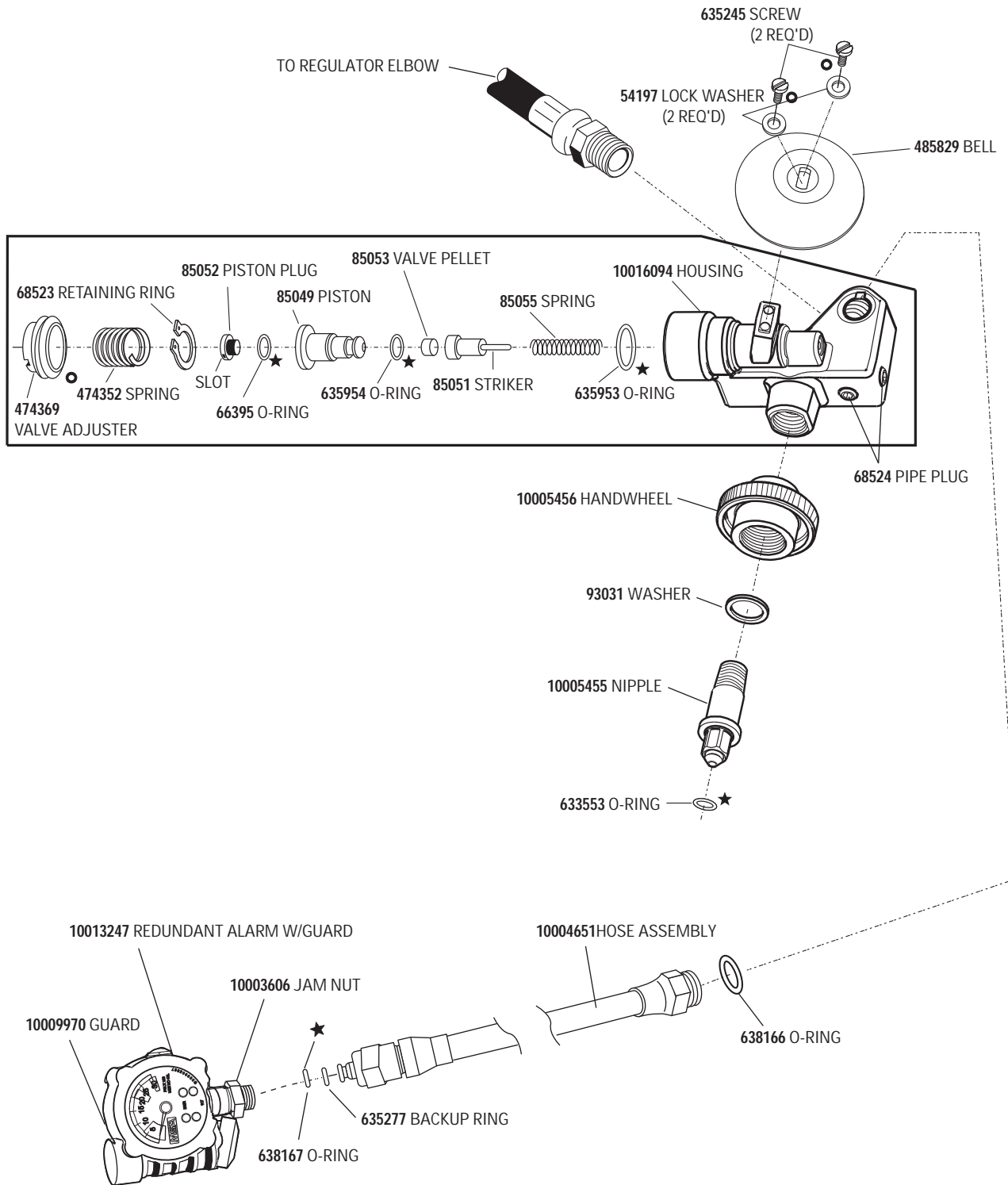

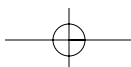
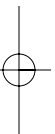
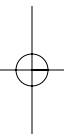
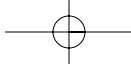

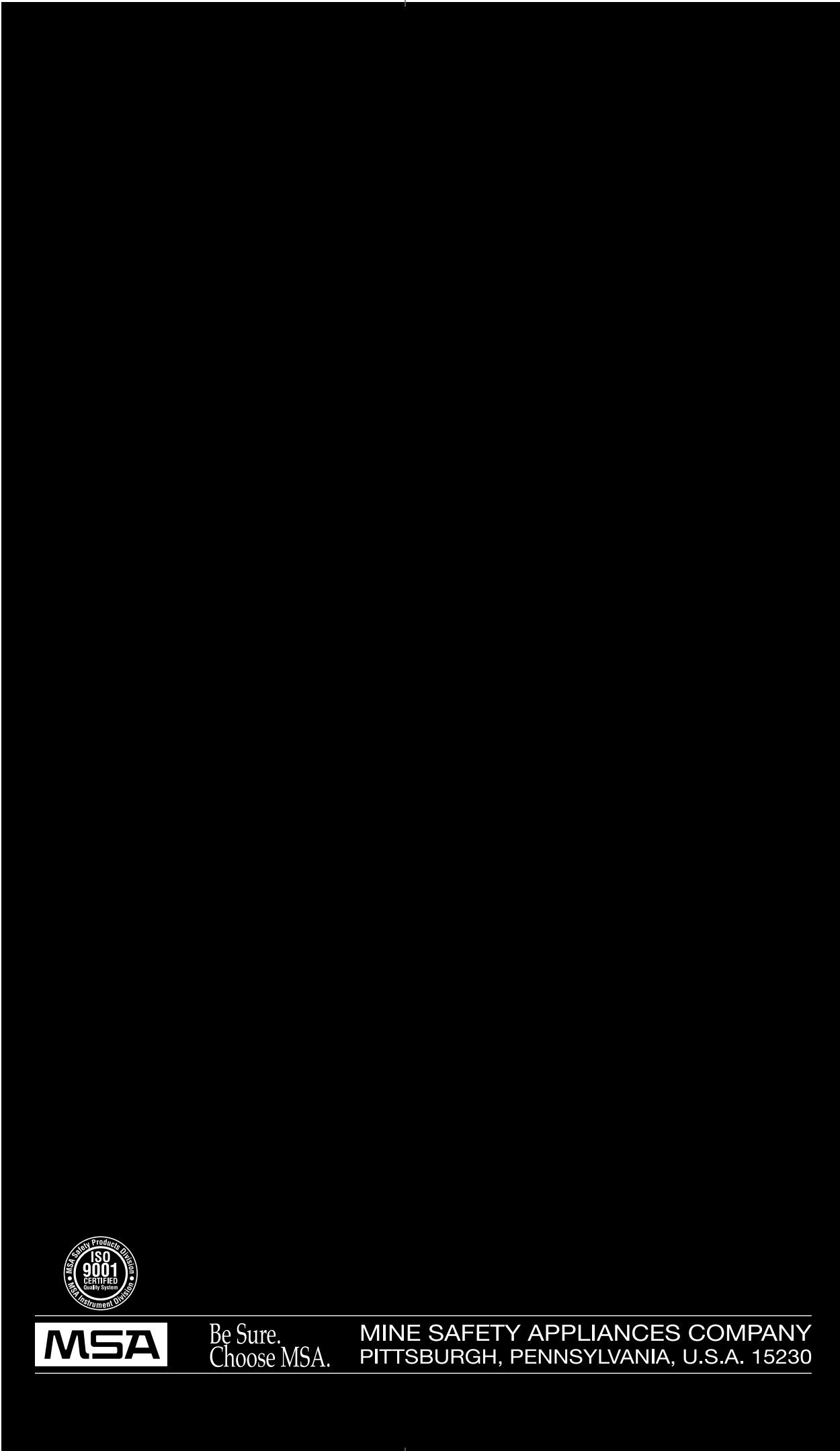

Be Sure.
Choose MSA.

MINE SAFETY APPLIANCES COMPANY
PITTSBURGH, PENNSYLVANIA, U.S.A. 15230