

# BMR Low Pressure

## PARTS LIST

### Certified Dual-Purpose Maintenance



Be Sure.  
Choose MSA.

MINE SAFETY APPLIANCES COMPANY  
PITTSBURGH, PENNSYLVANIA, U.S.A. 15230

# KEY

AIR MASK PARTS OUTLINED MAY  
ONLY BE PURCHASED BY TRAINED,  
CERTIFIED REPAIRMEN WITH A  
REGULATOR TESTER

▲ NOTE: THE REGULATOR ASSEMBLY NO. DOES NOT  
INCLUDE ELBOWS, HIGH PRESSURE HOSE AND  
AUDI-LARM

- ★ 604070 LUBRICANT
- USE LOCTITE 222 WHEN ASSEMBLING  
(MSA SEALANT P/N 29787)
- \* USE LOCTITE 290 WHEN ASSEMBLING  
(MSA SEALANT P/N 6000469)

# Pressure Demand Regulator

## Prior Design

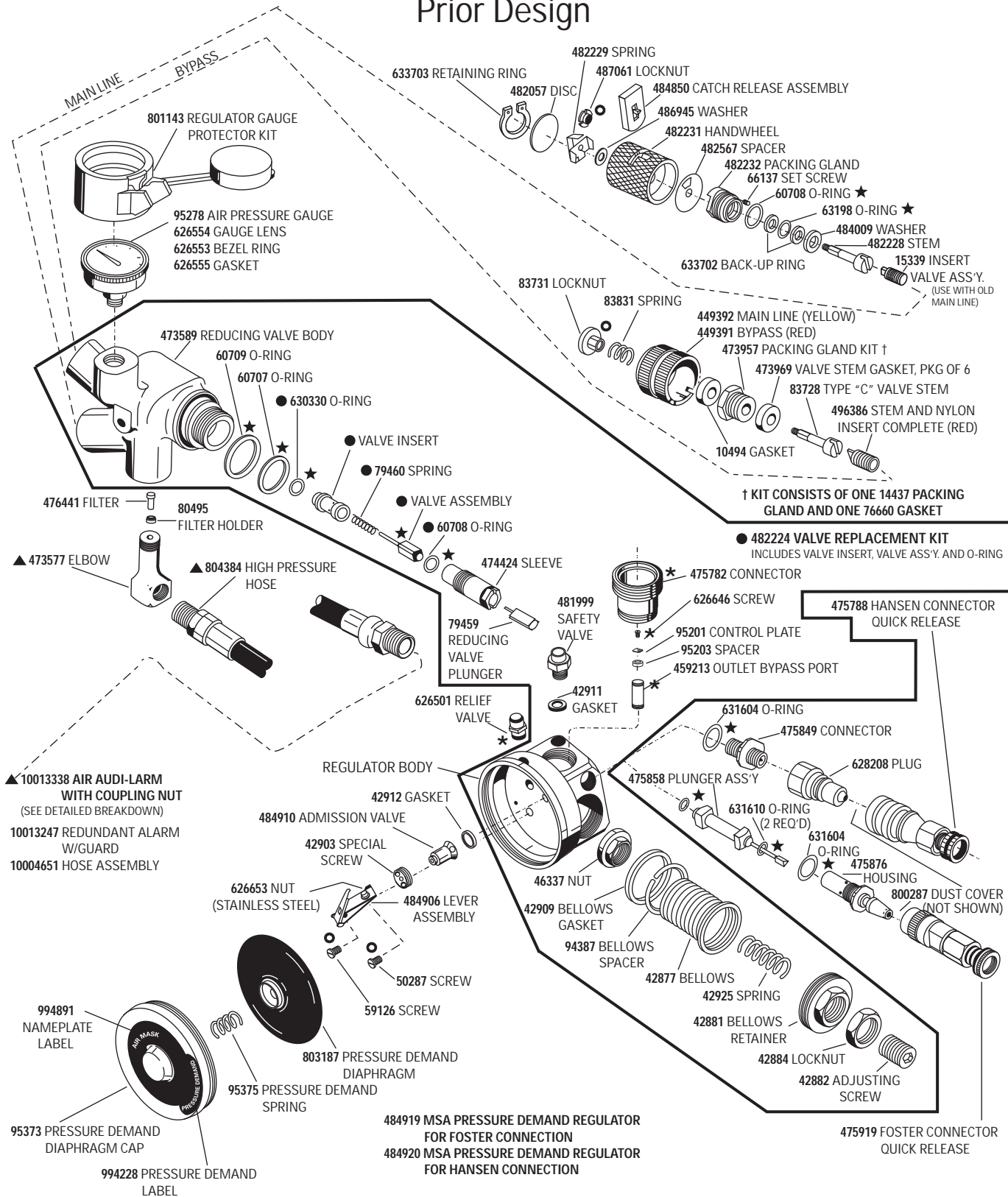

# Pressure Demand Regulator

## Current Design

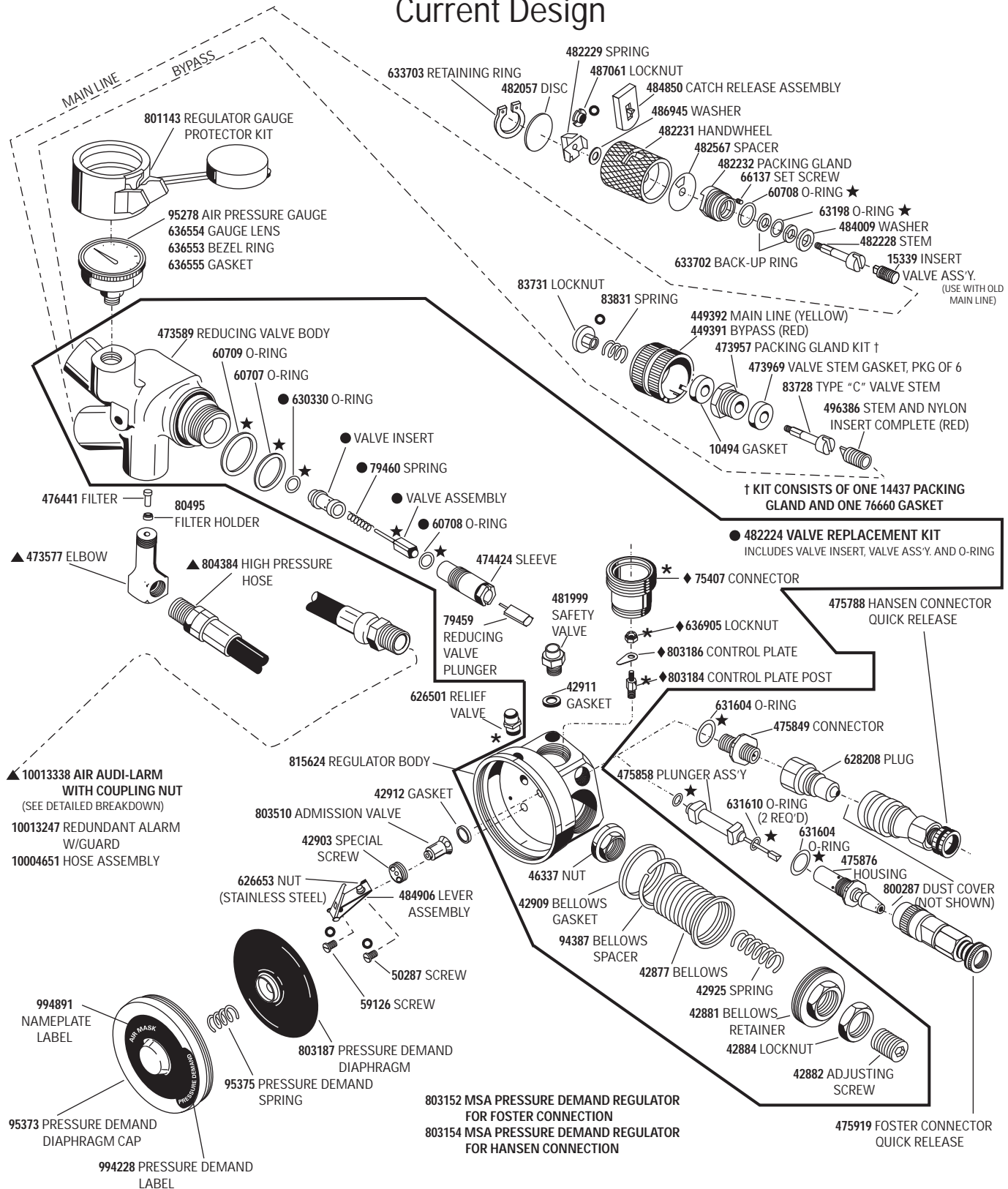

◆ PARTS COME WITH 815624 REGULATOR BODY

# Quick-Fill Fitting Assembly

part number 473577

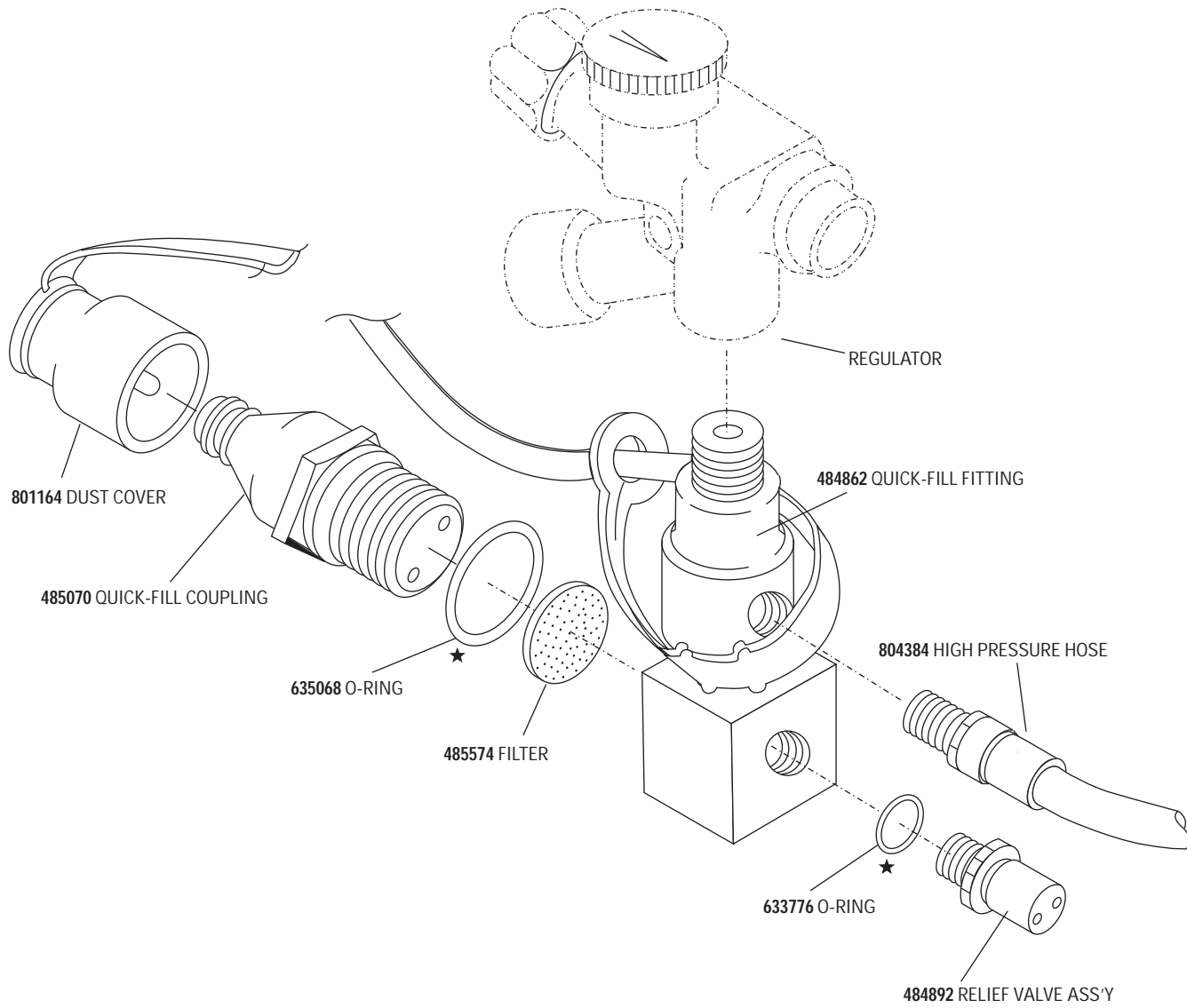

# Audi-Larm™ Assembly

part number 10013338

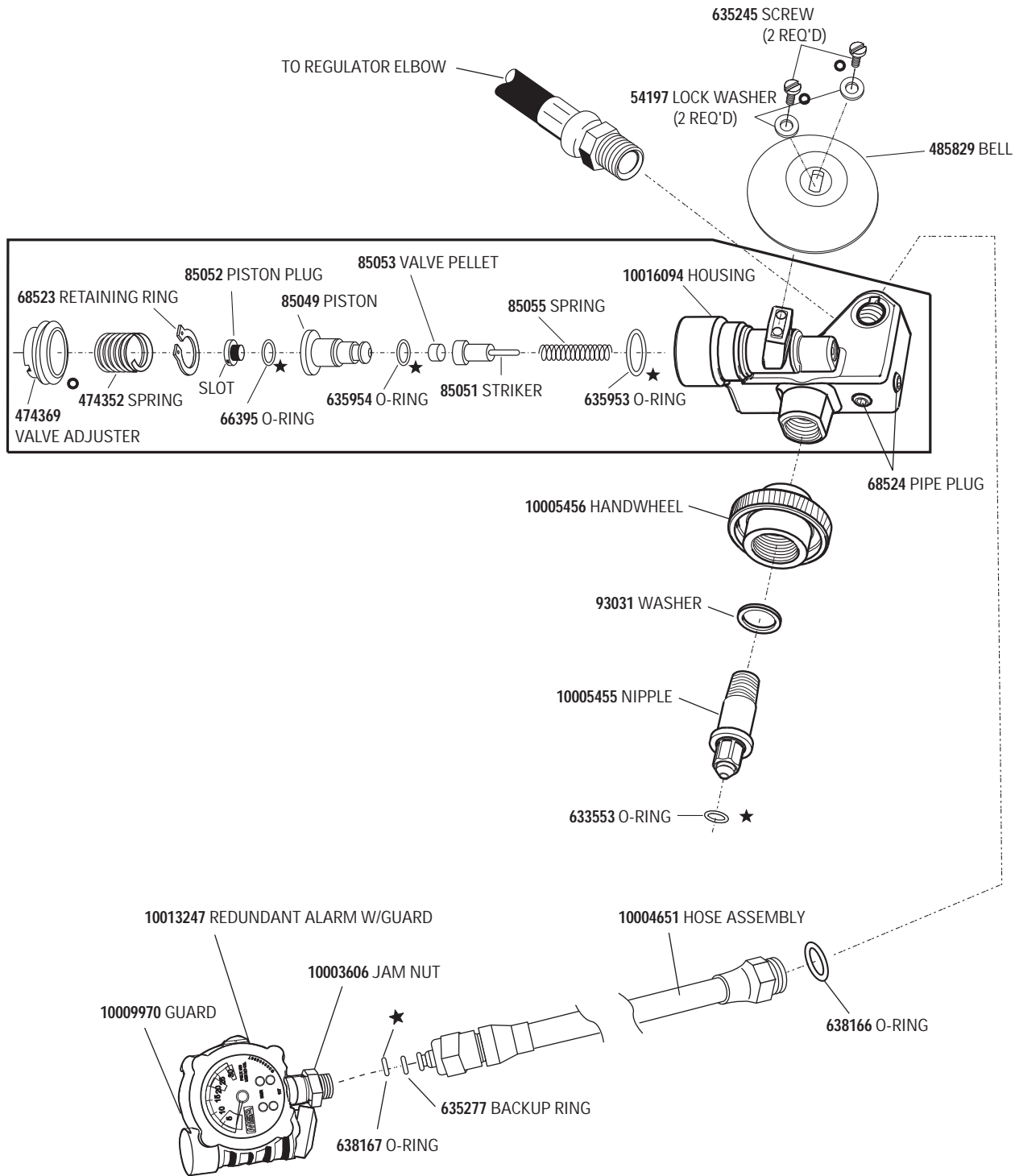

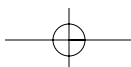
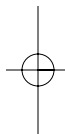
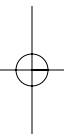
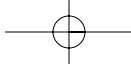

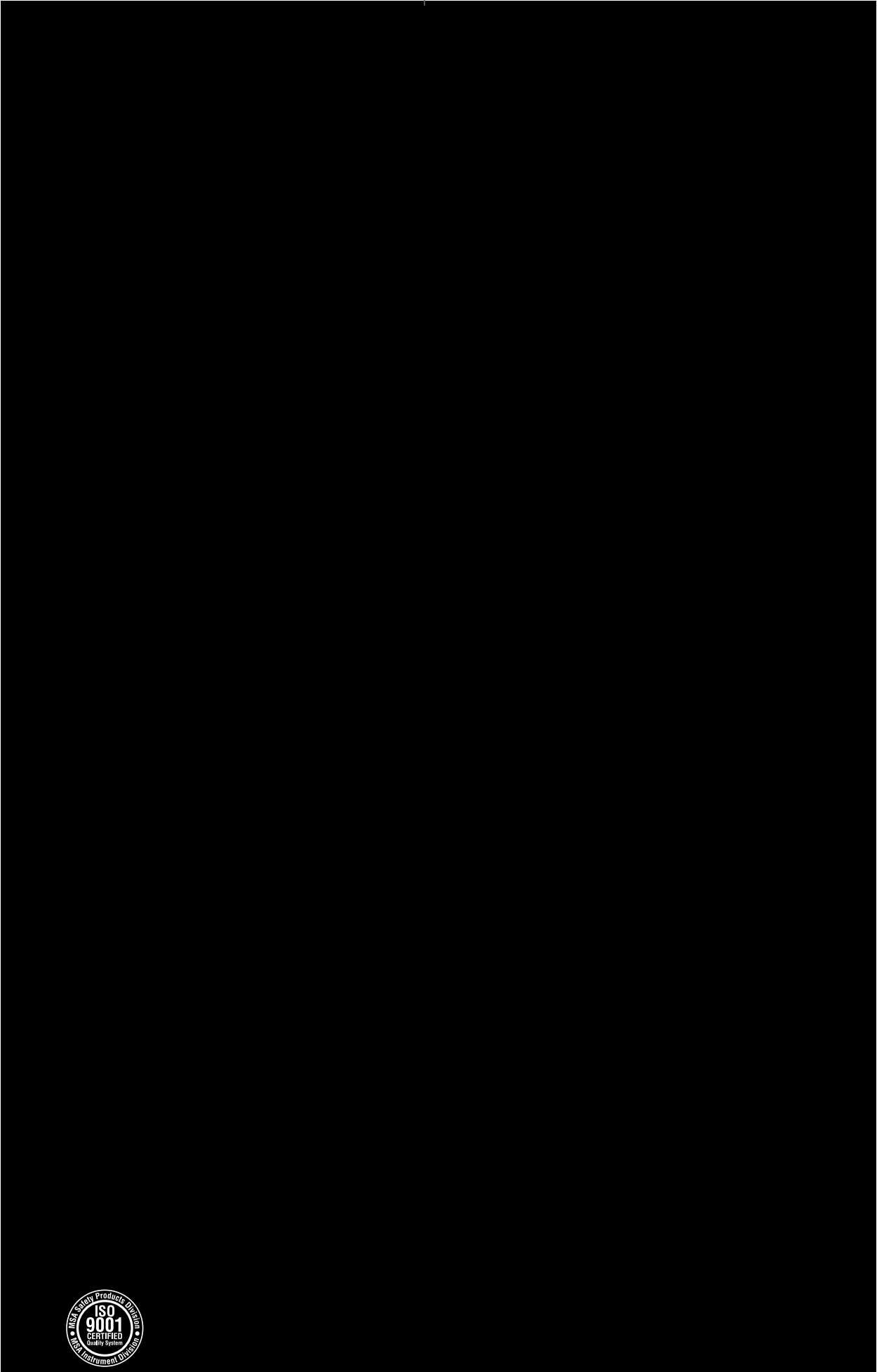

Be Sure.  
Choose MSA.

MINE SAFETY APPLIANCES COMPANY  
PITTSBURGH, PENNSYLVANIA, U.S.A. 15230