

BMR High Pressure

PARTS LIST

Certified Dual-Purpose Maintenance



Be Sure.
Choose MSA.

MINE SAFETY APPLIANCES COMPANY
PITTSBURGH, PENNSYLVANIA, U.S.A. 15230

KEY

AIR MASK PARTS OUTLINED MAY
ONLY BE PURCHASED BY TRAINED,
CERTIFIED REPAIRMEN WITH A
REGULATOR TESTER

▲ NOTE: THE REGULATOR ASSEMBLY NO. DOES NOT
INCLUDE ELBOWS, HIGH PRESSURE HOSE AND
AUDI-LARM

- ★ 604070 LUBRICANT
- USE LOCTITE 222 WHEN ASSEMBLING
(MSA SEALANT P/N 29787)
- * USE LOCTITE 290 WHEN ASSEMBLING
(MSA SEALANT P/N 6000469)

Pressure Demand Regulator

Prior Design

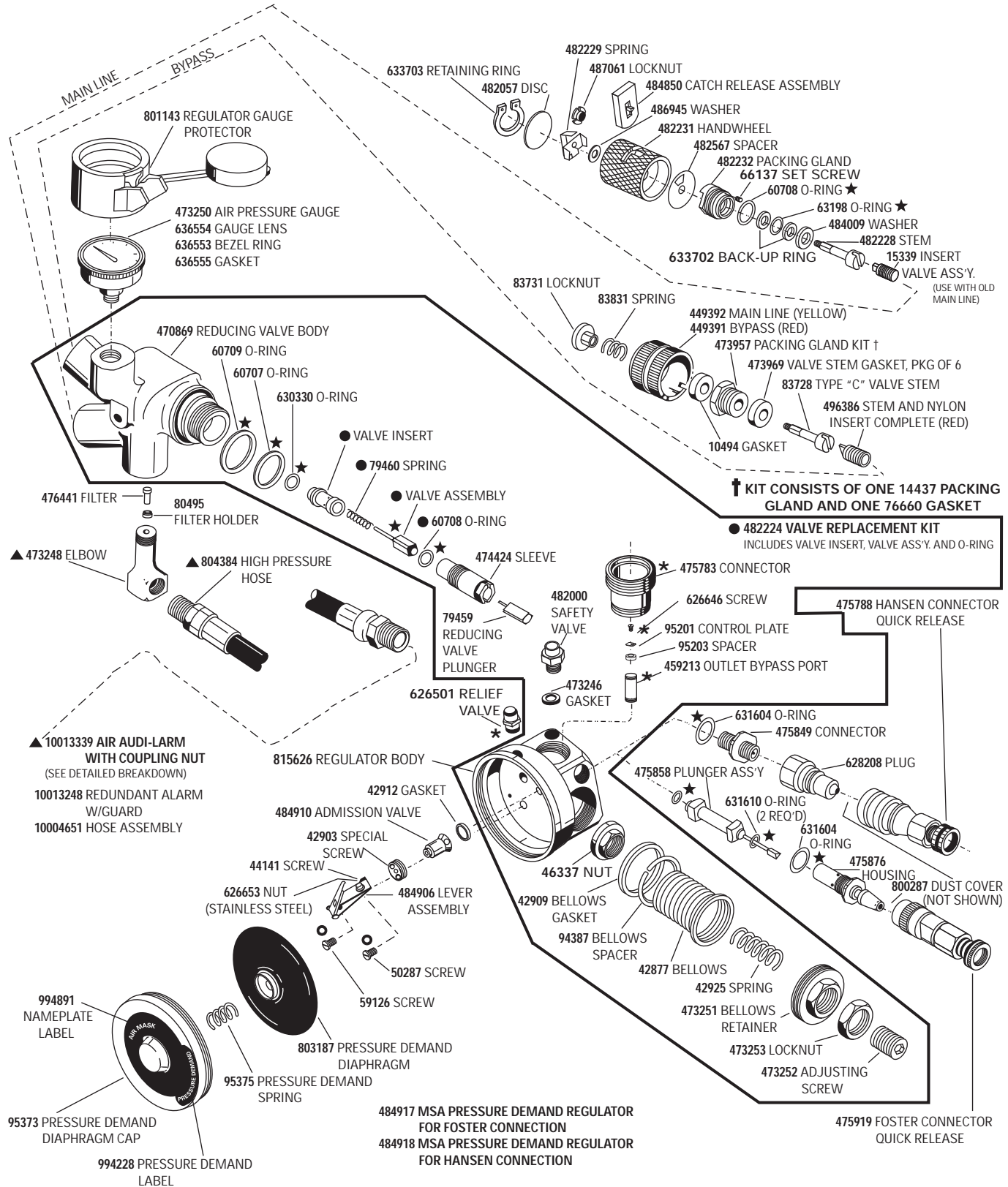

Pressure Demand Regulator

Current Design

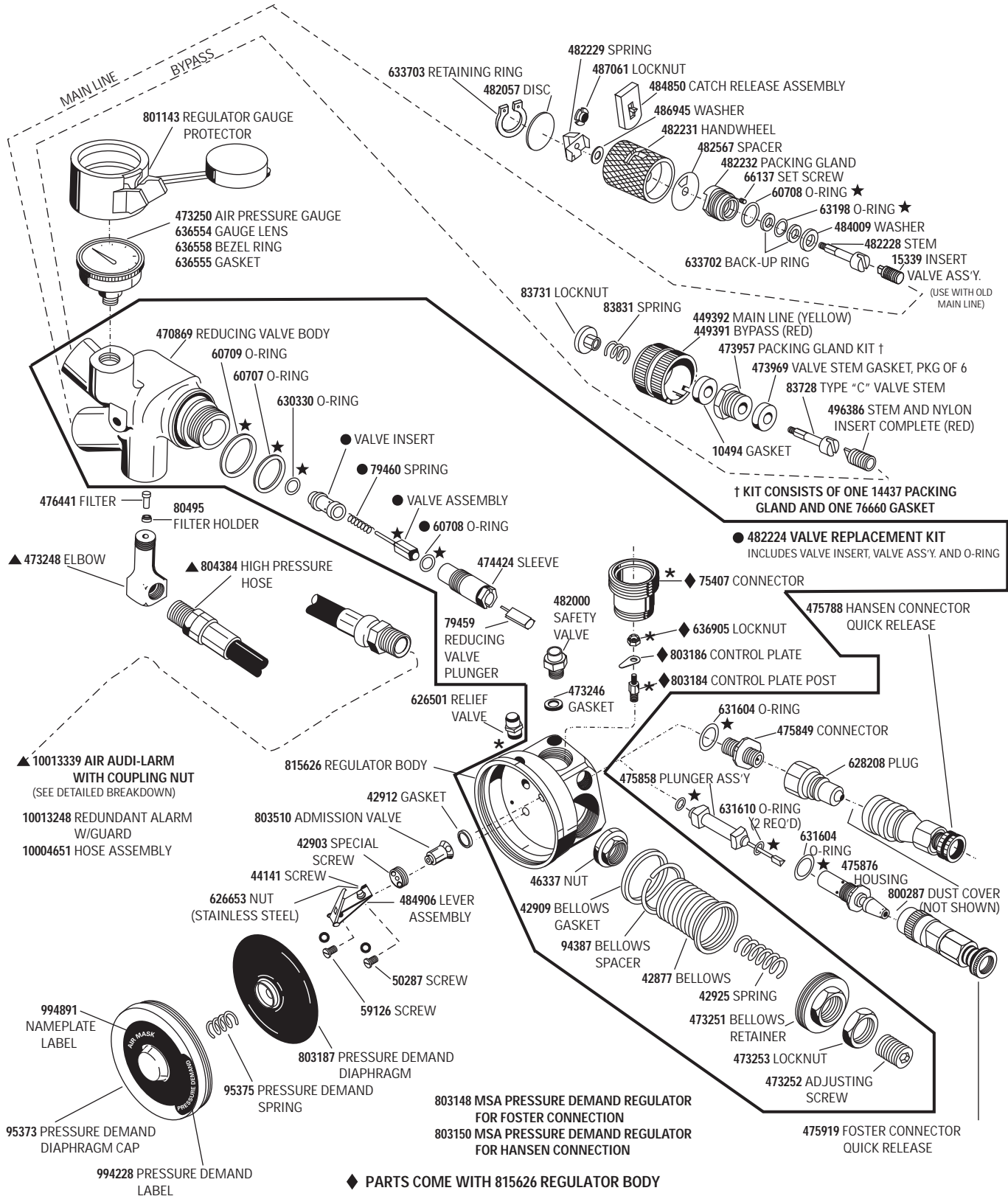

Quick-Fill Fitting Assembly

part number 473248

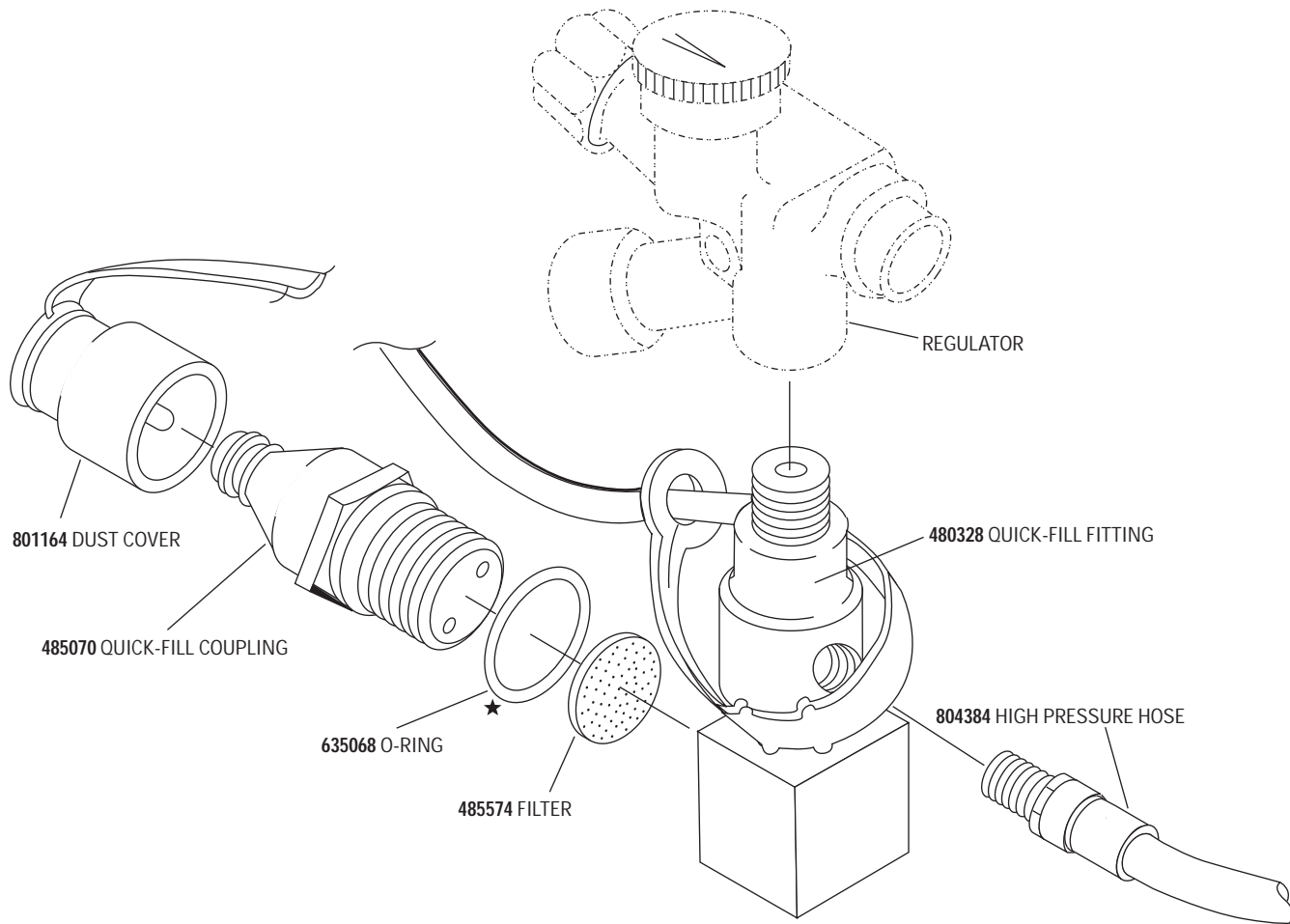

Audi-Larm™ Assembly

part number 10013339

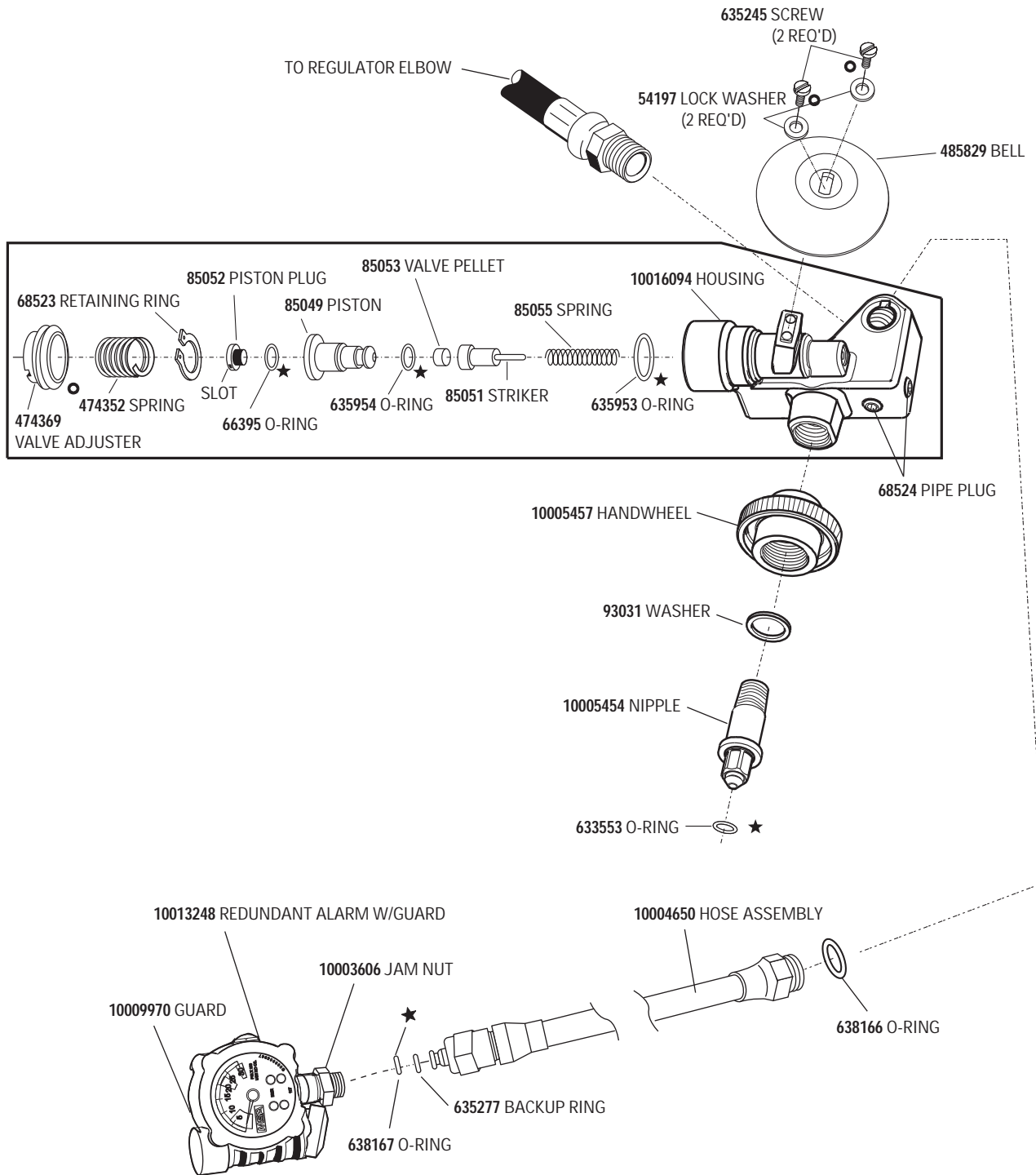

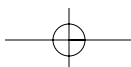
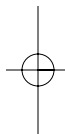
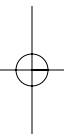
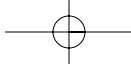



MSA

Be Sure.
Choose MSA.

MINE SAFETY APPLIANCES COMPANY
PITTSBURGH, PENNSYLVANIA, U.S.A. 15230