

BMR High Pressure

PARTS LIST

Certified Maintenance



MSA

Be Sure.
Choose MSA.

MINE SAFETY APPLIANCES COMPANY
PITTSBURGH, PENNSYLVANIA, U.S.A. 15230

KEY

AIR MASK PARTS OUTLINED MAY
ONLY BE PURCHASED BY TRAINED,
CERTIFIED REPAIRMEN WITH A
REGULATOR TESTER

▲ NOTE: THE REGULATOR ASSEMBLY NO. DOES NOT
INCLUDE ELBOWS, HIGH PRESSURE HOSE AND
AUDI-LARM

- ★ 604070 LUBRICANT
- USE LOCTITE 222 WHEN ASSEMBLING
(MSA SEALANT P/N 29787)
- * USE LOCTITE 290 WHEN ASSEMBLING
(MSA SEALANT P/N 6000469)

Pressure Demand Regulator

Prior Design

part number 484915

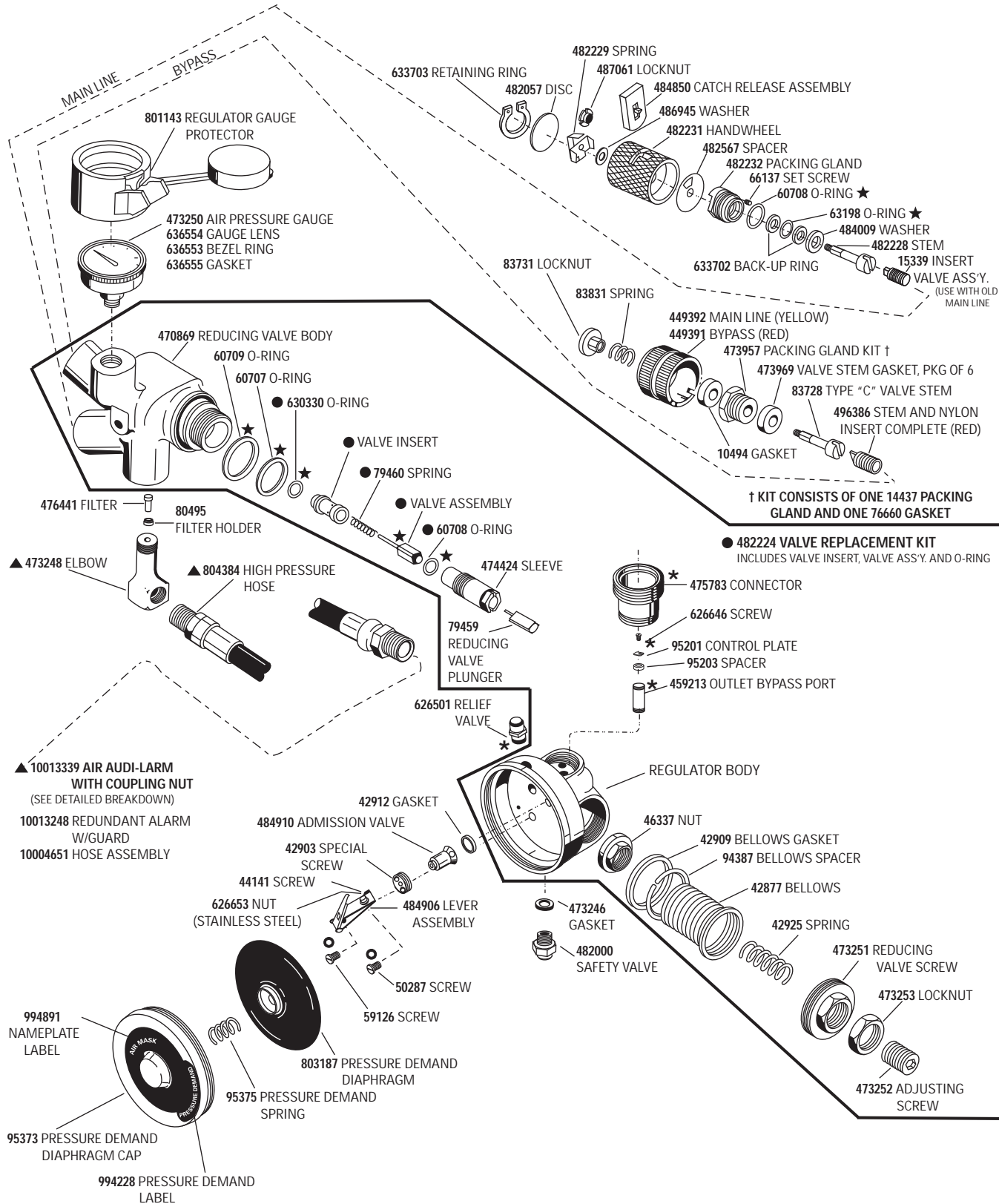

Pressure Demand Regulator

Current Design

part number 803144

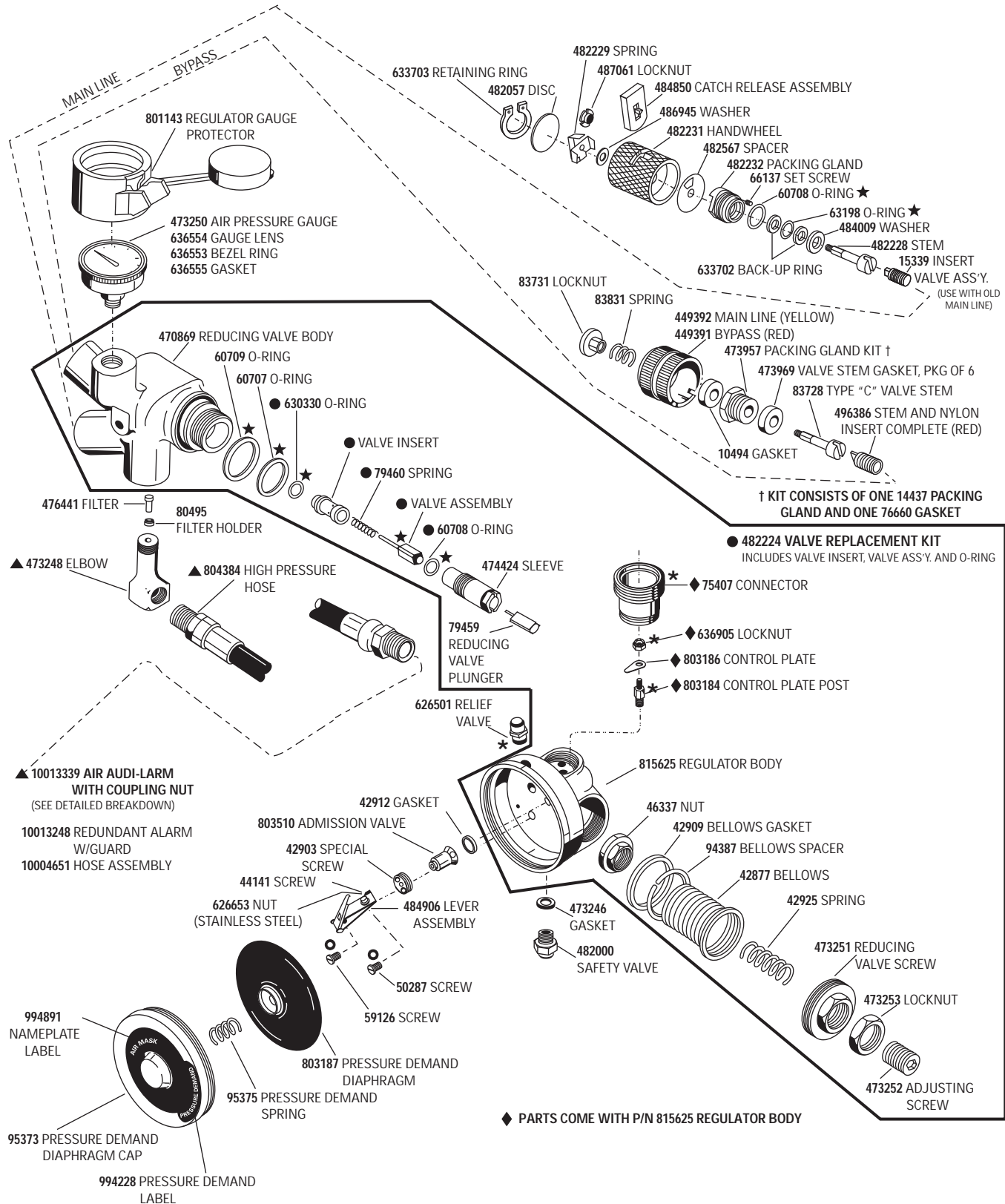

Quick-Fill Fitting Assembly

part number 473248

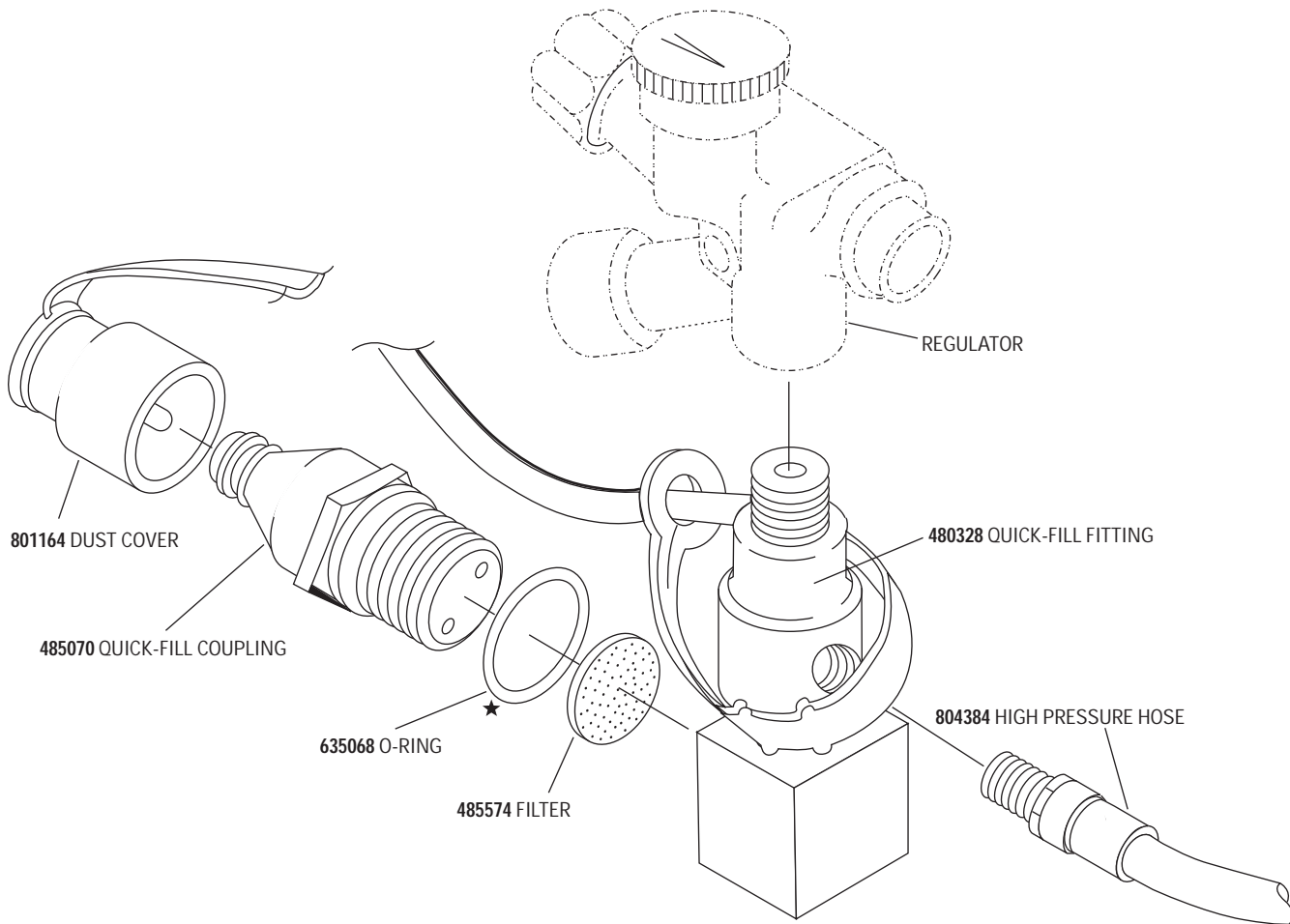

Audi-Larm™ Assembly

part number 10013339

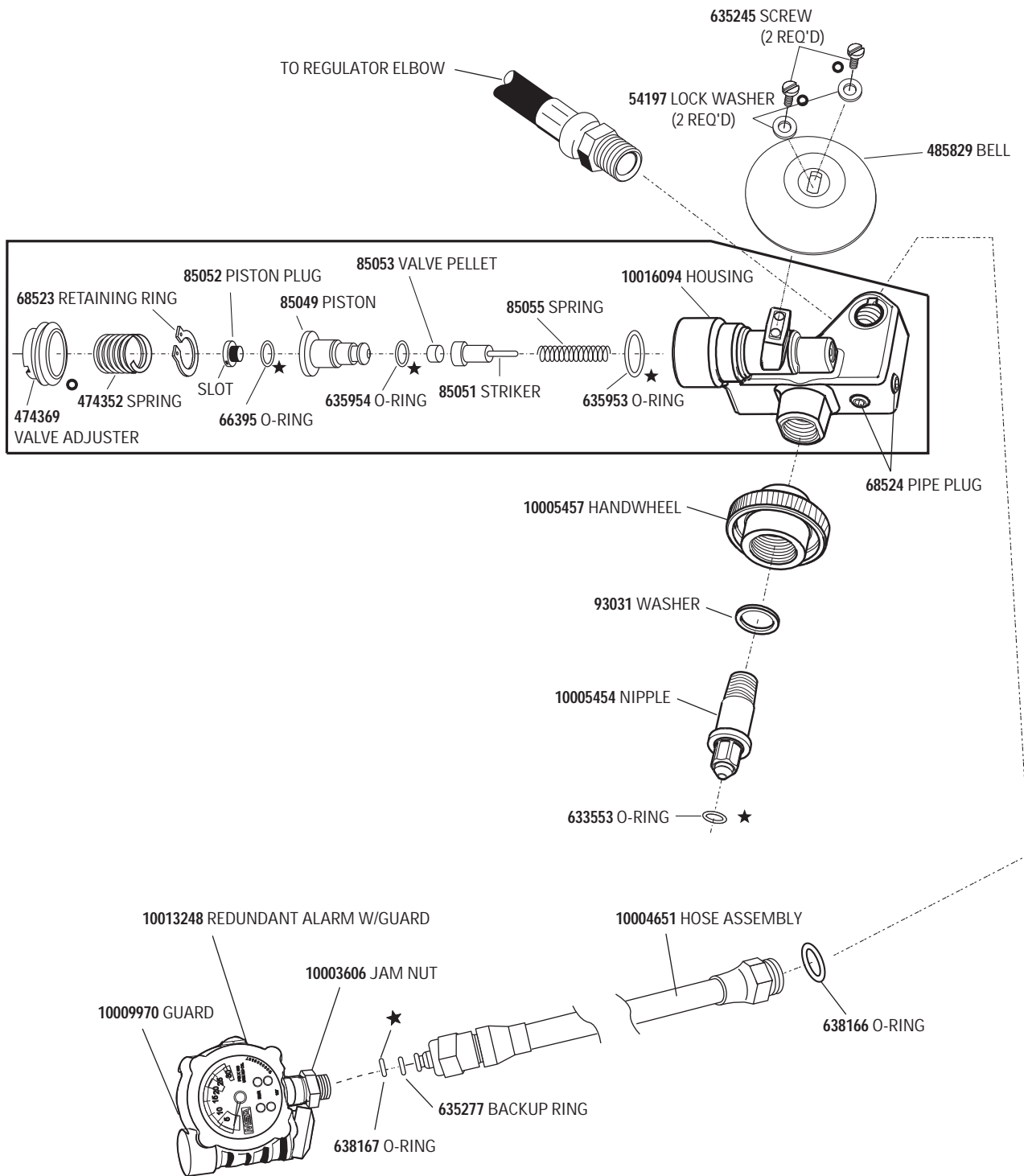

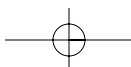
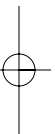
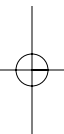
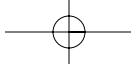



MSA

Be Sure.
Choose MSA.

MINE SAFETY APPLIANCES COMPANY
PITTSBURGH, PENNSYLVANIA, U.S.A. 15230