

TABLE
SETUP INSTRUCTIONS

HEX HEAD LEVELER FEATURE

Due to potential irregularities in your flooring surface your table may appear to be crooked. To realign your table, insert leveler and adjust as necessary.

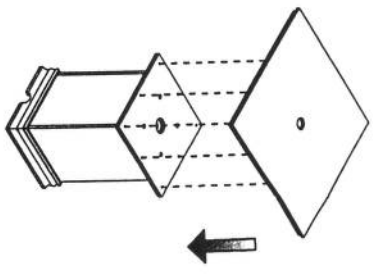

FIGURE 1

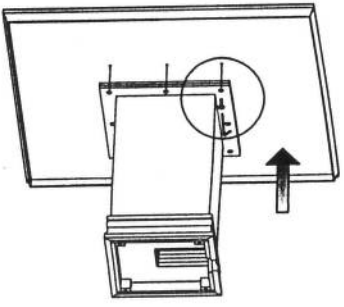
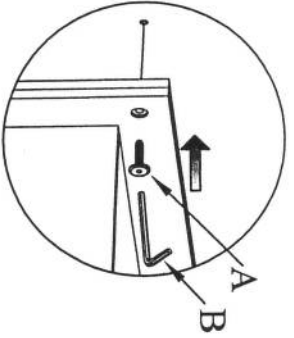

FIGURE 2



DETAIL "A"

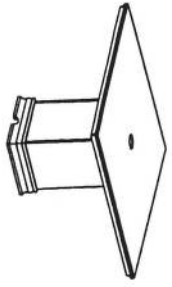

FIGURE 3

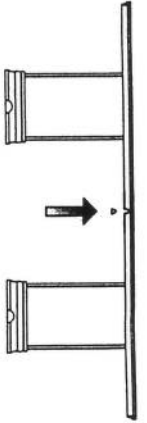

FIGURE 4

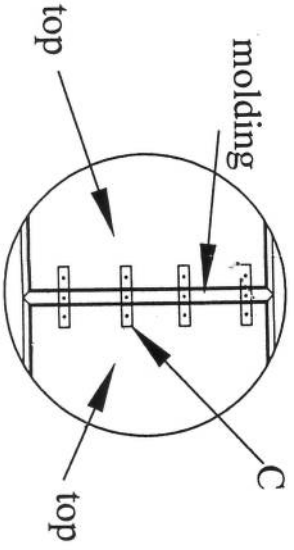

FIGURE 5

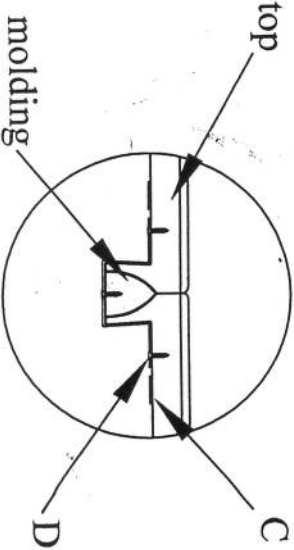

FIGURE 6

ATTACHMENT INSTRUCTIONS

1. Locate the top on the table (fig. 1).
2. Install eight 30mm Bolts (A) into the hole with wrench provided (B) as shown in figure 2 (detail "A").
3. Table image complete (fig. 3).
4. If you have two or more tables need locate two molding between tables as shown in figure 4.
5. Install four brackets (C) (to support moldings) with three screws (D) per bracket as shown in fig. 5 and fig. 6.

No:	Hardware List	Qty
A	30mm KD BOLT	8
B	WRENCH	1
C	BRACKET	4
D	$\frac{5}{8}$ " MACHINE SCREW	12

Tools required: Phillips screw driver