

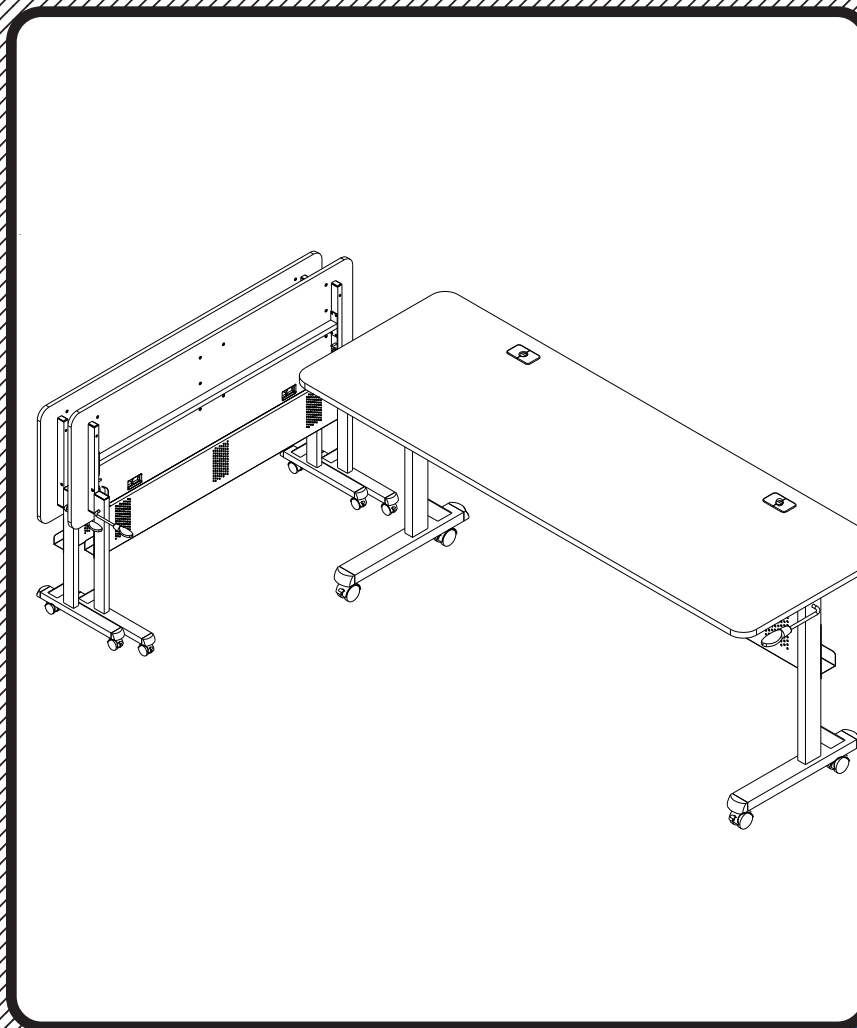

#89863

Flipper-72











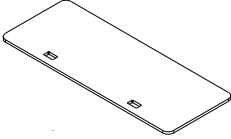
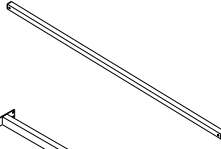
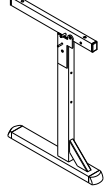
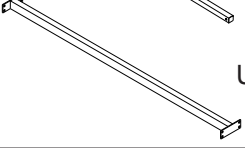
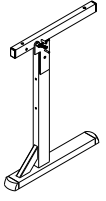

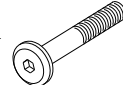
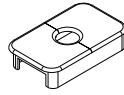





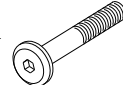
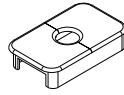

72" Conference Table

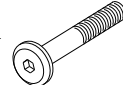
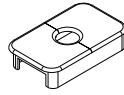

Assembly Instructions

Flipper-72

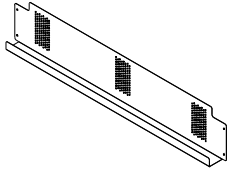
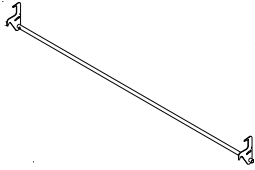
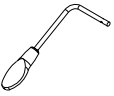
72" Conference Table

Part	Drawing	Description	Qty	Part	Drawing	Description	Qty																												
P1		Top Platform	1 EA	P8		Lower Crossbrace	1 EA																												
P2		Left Leg	1 EA	P9		Upper Crossbrace	1 EA																												
P3		Right Leg (with Spring)	1 EA	<div style="border: 2px solid black; border-radius: 15px; padding: 10px;"> <p style="text-align: center;">Hardware List</p> <table style="width: 100%; border-collapse: collapse;"> <tr> <td style="width: 5%;">A</td> <td style="width: 15%;"></td> <td style="width: 60%;">9/16" Socket Screw</td> <td style="width: 20%;">12 EA</td> </tr> <tr> <td>A1</td> <td></td> <td>1-3/8" Socket Screw</td> <td>2 EA</td> </tr> <tr> <td>B</td> <td></td> <td>1-7/8" Socket Screw</td> <td>4 EA</td> </tr> <tr> <td>C</td> <td></td> <td>Plastic Grommet</td> <td>2 EA</td> </tr> <tr> <td>D</td> <td></td> <td>2" Locking Caster</td> <td>4 EA</td> </tr> <tr> <td>E</td> <td></td> <td>Allen Wrench</td> <td>1 EA</td> </tr> <tr> <td>F</td> <td></td> <td>Caster Wrench</td> <td>1 EA</td> </tr> </table> </div>				A		9/16" Socket Screw	12 EA	A1		1-3/8" Socket Screw	2 EA	B		1-7/8" Socket Screw	4 EA	C		Plastic Grommet	2 EA	D		2" Locking Caster	4 EA	E		Allen Wrench	1 EA	F		Caster Wrench	1 EA
A		9/16" Socket Screw	12 EA																																
A1		1-3/8" Socket Screw	2 EA																																
B		1-7/8" Socket Screw	4 EA																																
C		Plastic Grommet	2 EA																																
D		2" Locking Caster	4 EA																																
E		Allen Wrench	1 EA																																
F		Caster Wrench	1 EA																																
P4		Metal Stability Panel	1 EA																																
P5		Welded Rod Assembly	1 EA																																
P6		Left Side Handle	1 EA																																
P7		Right Side Handle	1 EA																																
				<p><i>We recommend that you assemble this unit on a table.</i></p>																															

Missing Parts or UPS Damaged Parts

For Your Convenience you can
EMAIL us at
furniture@baltinc.com
24HOURS 7 DAYS A WEEK

***Should you require assistance during assembly,
please call our Customer Service Department
Monday - Friday 8 a.m. - 5 p.m.
Central Standard Time 1-800-749-2258***

Do not use unless all screws are tight. At least every six months, check all screws to be sure they are tight. If parts are missing, broken, damaged, or worn, stop use of the product until repairs are made by your dealer using factory authorized parts.

Flipper-72 Assembly Diagram



READ THROUGH INSTRUCTIONS FROM BEGINNING TO END BEFORE STARTING TO ASSEMBLE UNIT.

- 1.) Identify and Separate all the Parts and Hardware.
- 2.) Slide the Right Side Handle (P7) Through the Right Leg (P-3) and into the Welded Rod (P5) as shown in illustration #1. Rotate Right Side Handle (P7) until holes are aligned (See illustration#1). Secure using 1 Screw (A).
- 3.) Slide the Left Side Handle (P6) Through the Left Leg (P-2) and into the Welded Rod (P5) as shown in illustration #1. Rotate Left Side Handle (P6) until holes are aligned (See illustration #1). Secure using 1 Screw (A).

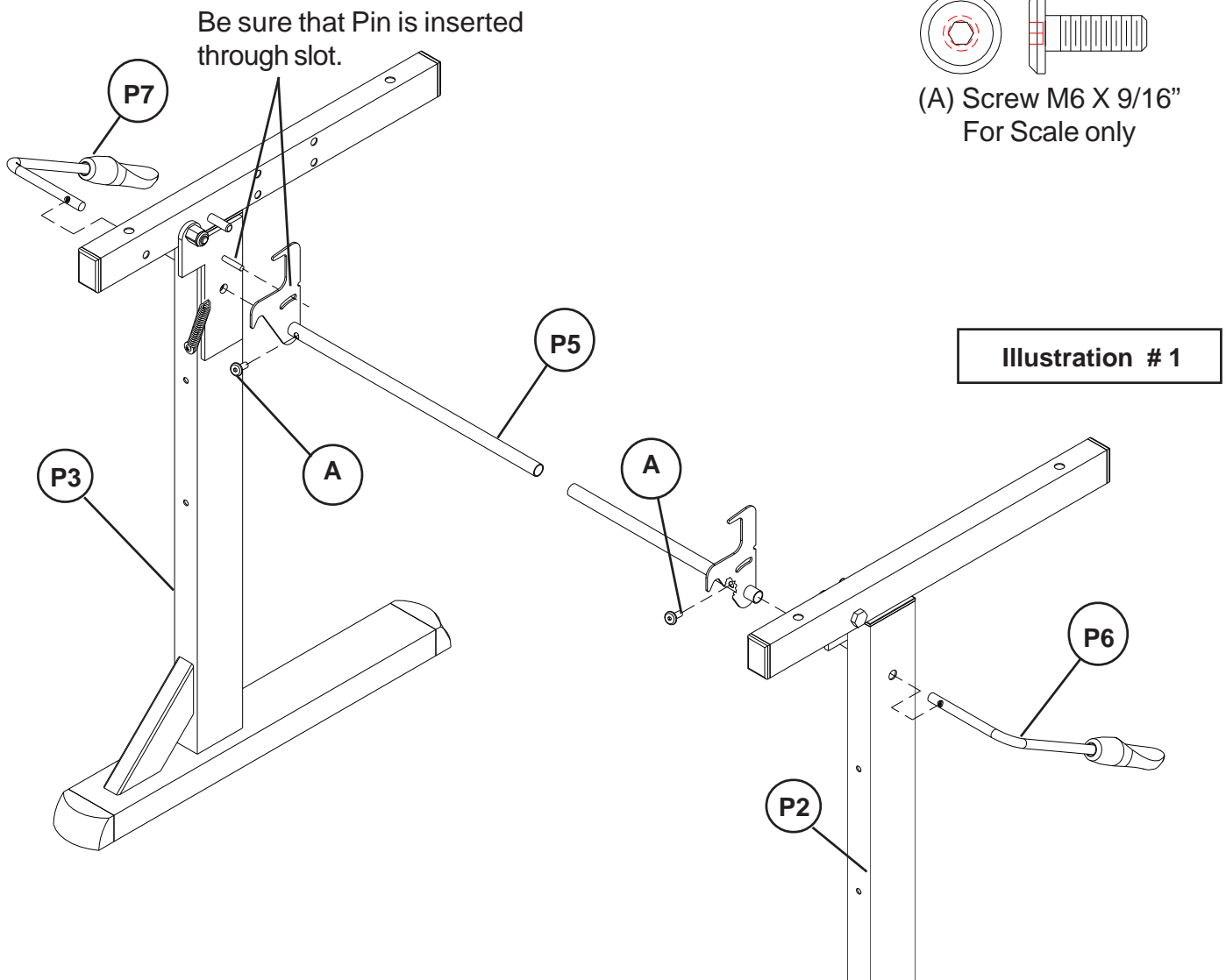

4.) Attach Metal Stability Panel (P4) and Lower Crossbrace (P-8) to the Right Leg (P-3) and Left Leg (P2) using 2 Screws (A) and 2 Screws (A1) as shown in illustration #2.

Illustration #2

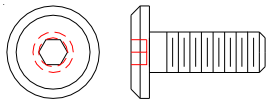
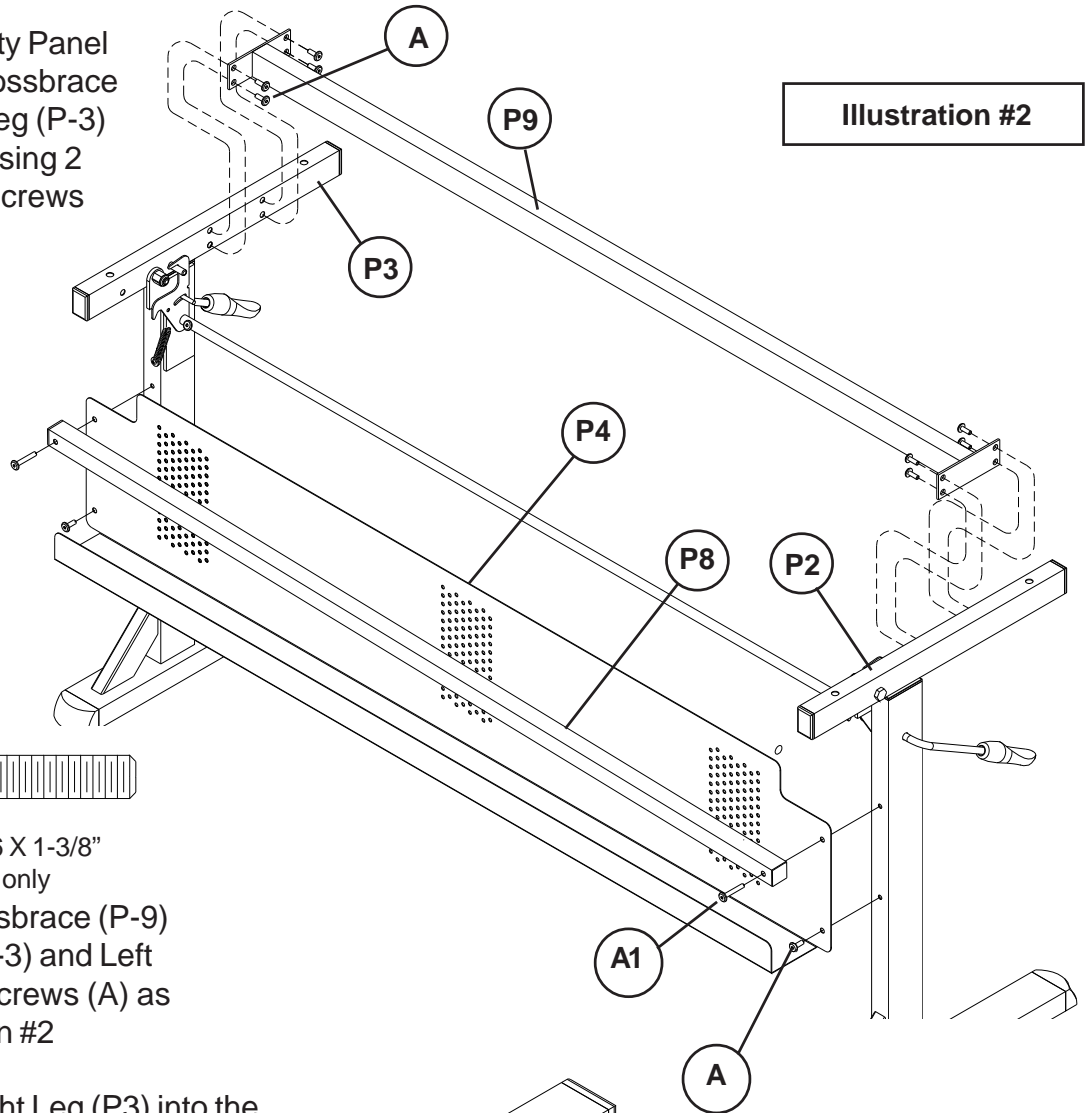

(A) Screw M6 X 9/16"
For Scale only

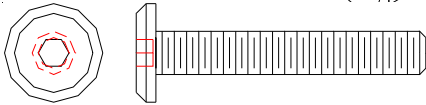

(A1) Screw M6 X 1-3/8"
For Scale only

5.) Attach Upper Crossbrace (P-9) to the Right Leg (P-3) and Left Leg (P2) using 8 Screws (A) as shown in illustration #2

6.) Insert Spring on Right Leg (P3) into the notch in Welded Rod (P5) as shown in illustration # 3.

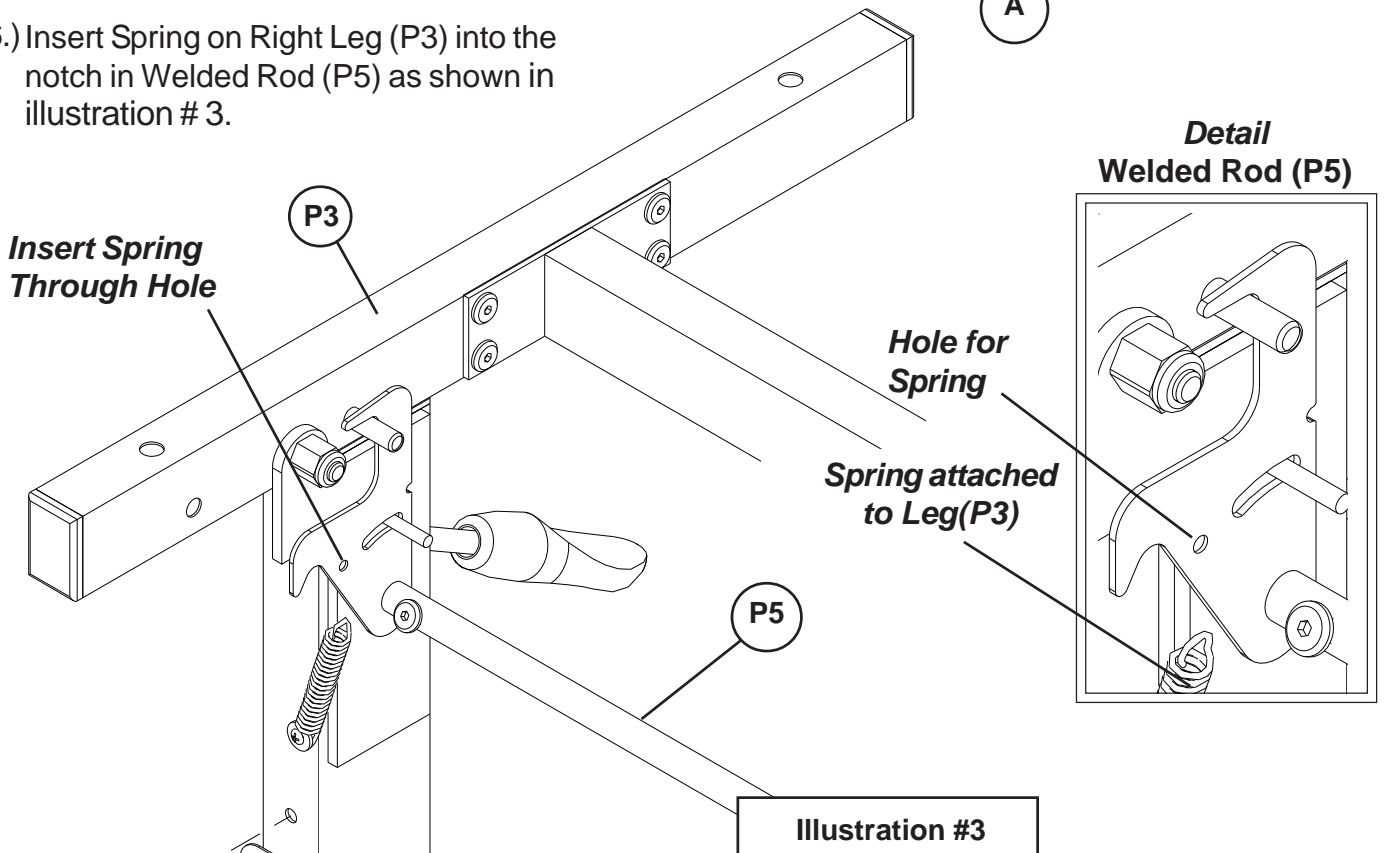

7.) Place the Top Platform (P1) with the insert nuts facing up. Attach Right Leg (P-3) and Left Leg (P2) using 4 each (B) screws as shown in illustration #4.
(Finger tighten only)

8.) Attach 4 each (D) Locking Casters to the front and back of the Right Leg (P-3) and Left Leg (P2). Tighten Casters using Caster Wrench (F).

(Tighten all screws using Allen Wrench (E).)

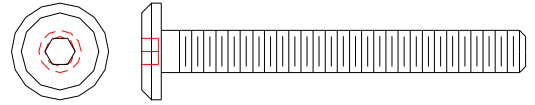

(B) Screw M6 X 1-7/8"
For Scale only

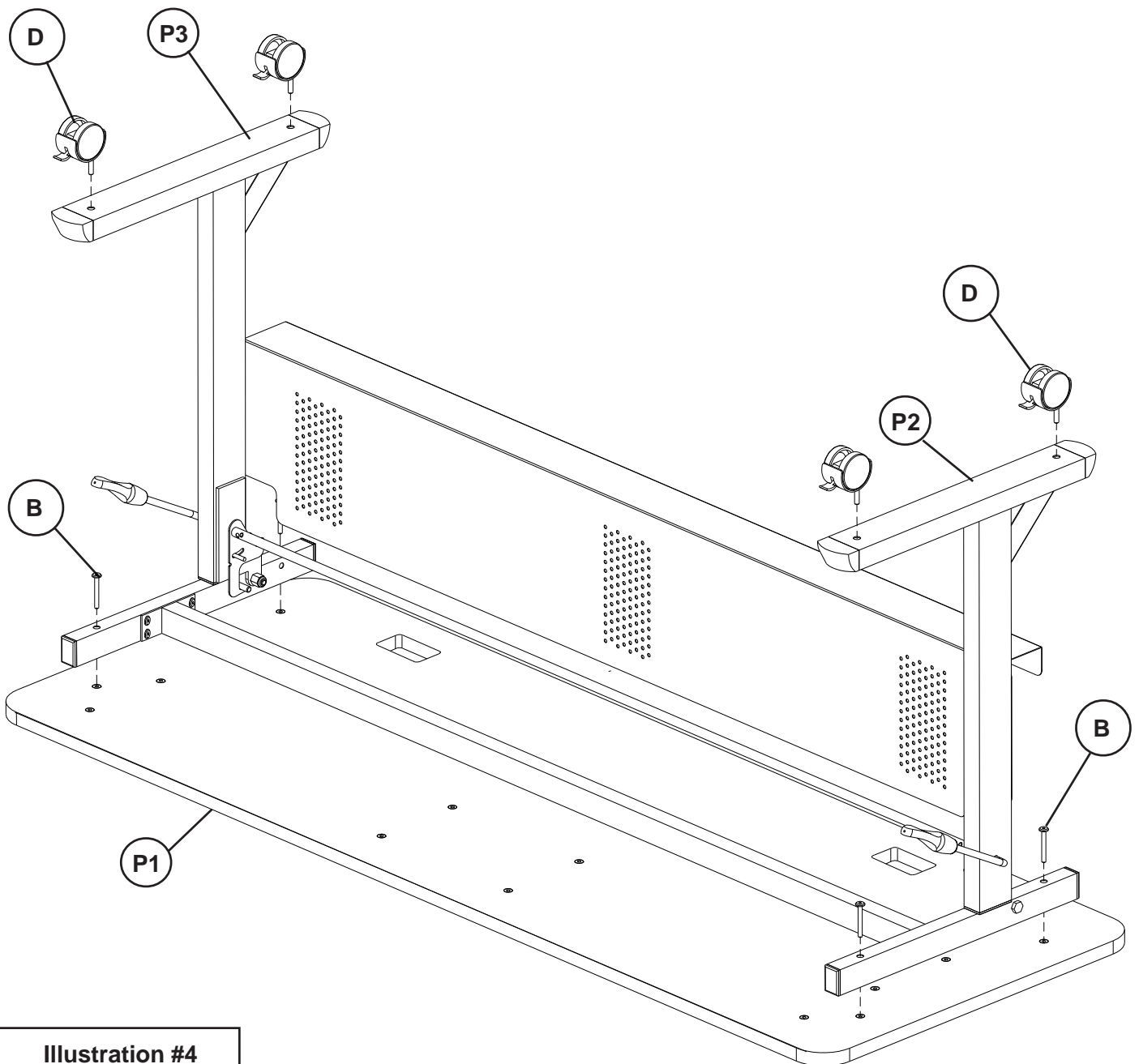

Illustration #4

9.) To install Grommet (C), separate parts and press Grommet Sleeve in rectangular openings in Top Platform (P1) as shown in illustration #5.

10.) Snap 2 plastic Caps over top of Sleeve as shown in illustration #5.

11.) Repeat Steps 9 & 10 for second Grommet (C).

Grommet(D) installation
Illustration #5

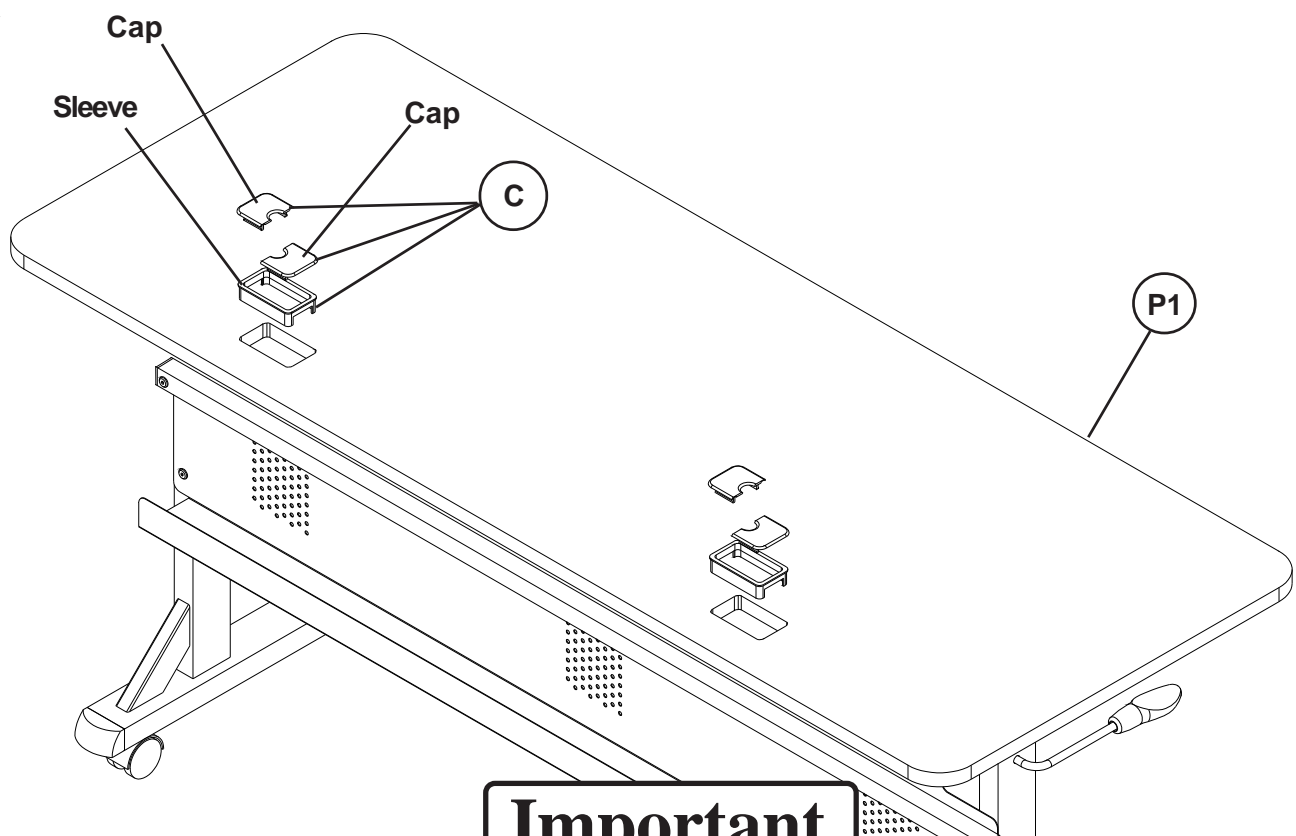
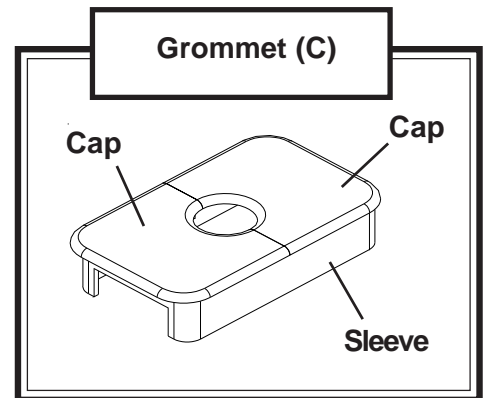

Important

The Balt product you have purchased is guaranteed against material and workmanship defects. This guarantee extends 1 year from date of purchase. Should this product fail to function satisfactorily under normal use due to defect or imperfection, the defective part or product will be replaced. Damage caused by common carriers during shipment is not included in this guarantee.

This guarantee sets forth all applicable guarantees and remedies. No other warranty, expressed or implied shall apply. Failure to follow instructions found in Important Information Section of Owner Sheet shall void the guarantee. Consequential or incidental damages and or costs are not refundable.