

PARTS

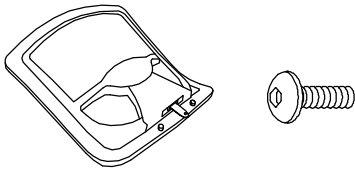

Backrest / QTY:1
Backrest Post Screw / QTY:1



Backrest Bolt + Washers :
QTY / 1 SET

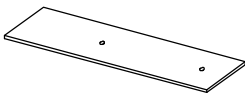

Backrest Post / QTY:1

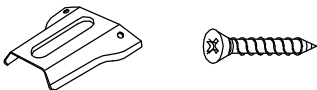

Backrest Post Cover / QTY:1
Backrest Post Cover Screw
QTY:2

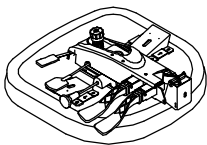

Seat + Mechanism + Arm Bracket
QTY:1

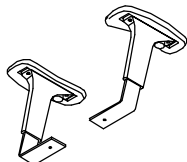

ARMRESTS / QTY: 2

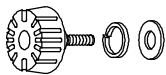

Width Adjustable Knob + Washers
QTY: 2 SETS

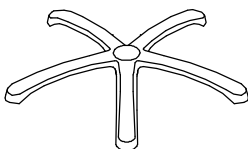

Base / QTY:1



Seat Lift / QTY:1

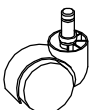

Casters / QTY: 5

Congratulations on the purchase of your new Signature Series chair!

INSTRUCTIONS

Remove all parts from carton and verify part quantities as indicated on parts lists.

Step 1. Insert the caster into the hole at the bottom of the five prong base.
Insert the bottom end of the seat lift into center hole of the base.

Step 2. Attach backrest post to back using one short backrest post screw.

Step 3-1. Insert backrest post into rear of mechanism and secure using one long backrest bolt, one split lock washer and one flat washer.

Step 3-2. Attach backrest post cover using two backrest post cover screws.

Step 3-3. Insert armrests into the brackets located at both sides of the seat.
Insert the width-adjustable knobs into the holes of brackets.
Adjust the width of the armrest to your preference and tighten securely.

Step 4. Place the chair body onto the small end of the seat lift.

Attention: MAKE SURE ALL SCREWS ARE FULLY TIGHTENED BEFORE USING CHAIR.

Step 1.

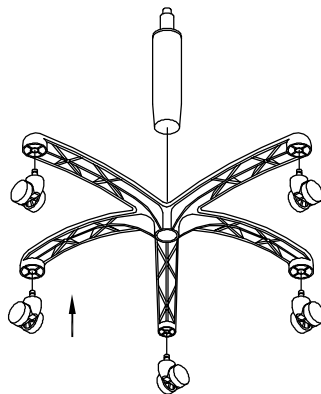

Step 2.

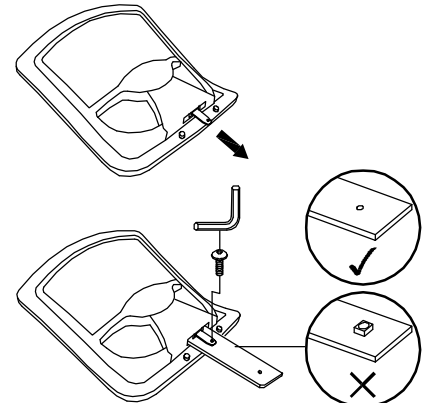

Step 3.

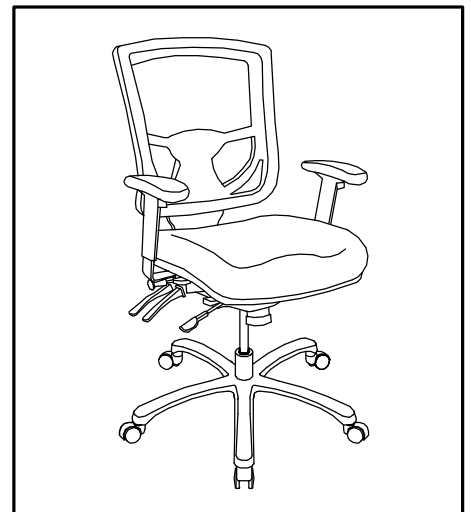
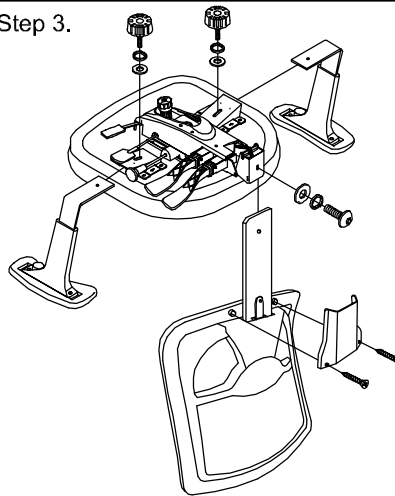

CUSTOMER SERVICE HOTLINE
800-626-6060

WWW.NBF.COM



ALLEN WRENCH SPARE PART
(SAVE FOR FUTURE TIGHTENING)