

Models: 4001C, 4003C, 4004C Axis Benches

Parts Listing

A
Bench
1 Unit

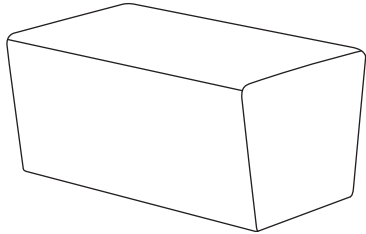

B
Frame
2 Units

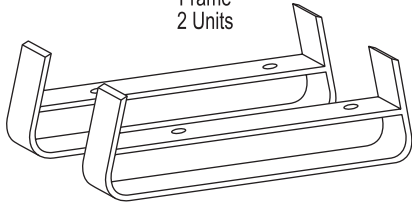

C
Screw
4 Units

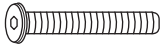

D
Lock Washer
4 Units



E
Allen Wrench
1 Unit

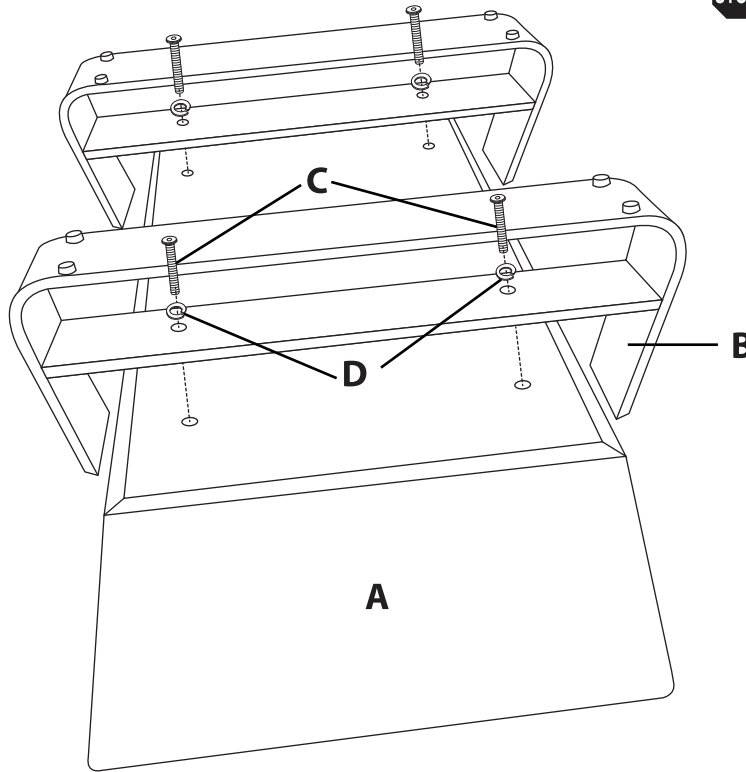

STOP Assembly Instructions

Tools Needed: Allen Wrench (provided)

Step 1: Remove pre-inserted Screws (C) and Lock Washers (D) from bottom of Bench (A). Attach Frames (B) by aligning the holes in the Frames (B) with the corresponding holes in Bench (A).

Step 2: Attach Frames (B) with Screws (C) by first putting Lock Washer (D) on Screws (C) and inserting them through the holes in the frame and into the Bench. Tighten using Allen Wrench (E).

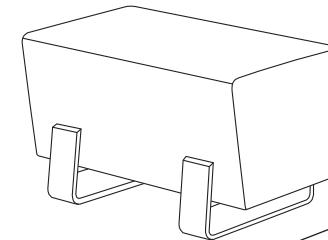

Model 4001C

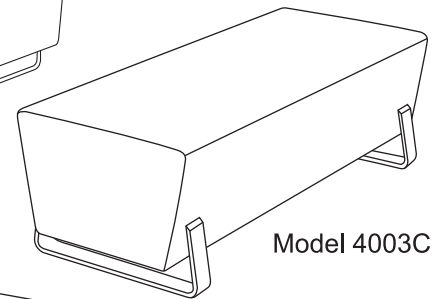

Model 4003C

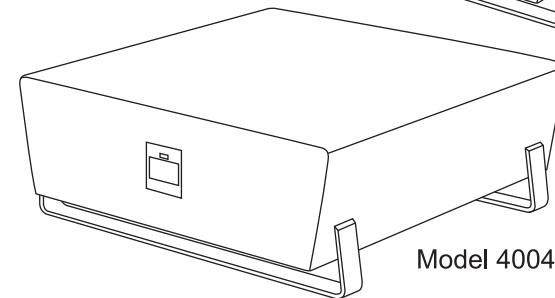

Model 4004C

WEIGHT CAPACITY: 500 lbs.

Assembly Notes:

During assembly, hand tighten screw only. When all screws are in place, you may then tighten all screws completely.

CAUTION:

1. Do not use this bench as a step ladder.
2. Check for loose screws and tighten them every 6 months.

ofm
Furniture For The Real Office™

161 Tradition Trail, Holly Springs, NC, 27540
800-520-7471 (voice) • 919-362-4765 (fax)
919-303-6389 (voice) • www.ofminc.com
support@ofminc.com