

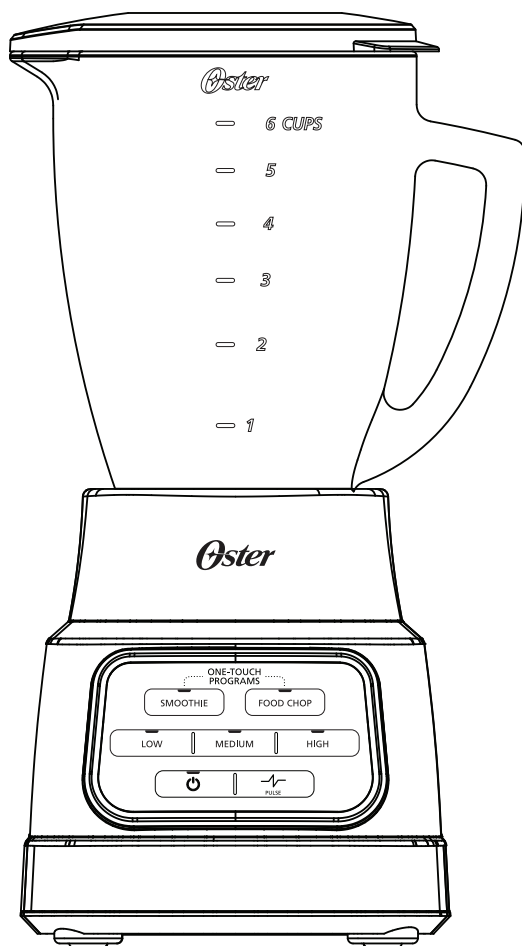

User Manual

Oster® One-Touch Blender With Pre-Programmed Settings



www.oster.com

P.N. 2132842

IMPORTANT SAFEGUARDS

When using electrical appliances, basic safety precautions should always be followed to reduce the risk of fire, electric shock, and/or injury to persons including the following:

1. Read all instructions before using this product.
2. To protect against electric shock, do not place or immerse cord, plugs, or appliance in water or other liquid.
3. This appliance is not intended for use by children or by persons with reduced physical, sensory, or mental capabilities, or lack of experience and knowledge. Close supervision is necessary when any appliance is used near children. Children should be supervised to ensure that they do not play with the appliance. Keep the appliance and its cord out of reach of children.
4. Never leave appliance unattended when in use.
5. Unplug from outlet when not in use, before putting on or taking off parts and before cleaning. Allow to cool before putting on or taking off parts, and before cleaning. To disconnect, turn any control to OFF, then unplug power cord from outlet. To unplug, grasp the plug and pull from the outlet. Never pull from the power cord.
6. Avoid contacting moving parts.
7. Flashing light indicates ready to operate. Avoid any contact with blades or moveable parts.
8. Do not operate any appliance with a damaged cord or plug or after the appliance malfunctions, or has been damaged in any manner. Do not attempt to replace or splice a damaged cord. Return appliance to the manufacturer (see warranty) for examination, repair or adjustment.
9. This appliance has important markings on the plug blade. The attachment plug is not suitable for replacement. If damaged, the appliance shall be replaced.
10. The use of attachments, including canning jars, not recommended or sold by the manufacturer may cause fire, electric shock or injury.
11. Do not use outdoors or for commercial purposes.
12. Do not let cord hang over edge of table or counter, or touch hot surfaces, including the stove.
13. Keep hands and utensils out of container while blending to reduce the risk of severe injury to persons or damage to the blender. A scraper may be used but must be used only when the blender is not running.
14. Blades are sharp. Handle carefully, especially when removing the blades from the container, emptying the container and during cleaning.
15. To reduce the risk of injury, never place cutter-assembly blades on base without jar properly attached.
16. Always hold container while operating the appliance. If the container should turn when the motor is turned ON, switch appliance OFF immediately and tighten the container in the threaded bottom.

2

17. Always operate blender with cover in place. Always wait until all moving parts have stopped before removing any lid or cover.
18. When blending hot liquids, remove center piece of two-piece cover. Beware of steam. Do not blend boiling liquids.
19. Do not use appliance for other than intended use. Misuse can cause injuries. Always use appliance on a dry, stable, level surface. Never fill beyond the MAX fill line.

SAVE THESE INSTRUCTIONS HOUSEHOLD USE ONLY

Note: The maximum rating marked on the product is based on the attachment that draws the greatest load. Other attachments may draw less power.

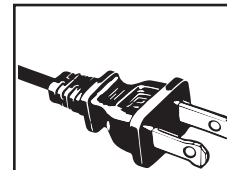

POLARIZED PLUG

This appliance has a polarized plug, (one blade is wider than the other). As a safety feature to reduce the risk of electrical shock, this plug is intended to fit in a polarized outlet only one way. If the plug does not fit fully in the outlet, reverse the plug. If it still does not fit, contact a qualified electrician. Do not attempt to defeat this safety feature or modify the plug in any way. If the plug fits loosely into the AC outlet or if the AC outlet feels warm do not use that outlet.

3

Welcome

Congratulations on your purchase of an Oster® Blender! To learn more about Oster® products, please visit us at www.oster.com.

FEATURES OF YOUR BLENDER

- A. Filler Cap for adding ingredients while blending
- B. Blender Lid
- C. Your Oster® Blender includes a 6-cup (1.4 L) Glass Jar
- D. Sealing Ring for tight seal
- E. Ice Crusher Blade that pulverizes ice
- F. Threaded Bottom Cap
- G. Blender Base
- H. Powerful motor with ALL-METAL-DRIVE for lasting durability
- I. Pre-Programmed Settings: Smoothie and Food Chop
- J. Power Button
- K. Manual Settings: Low, Medium, High
- L. Pulse button

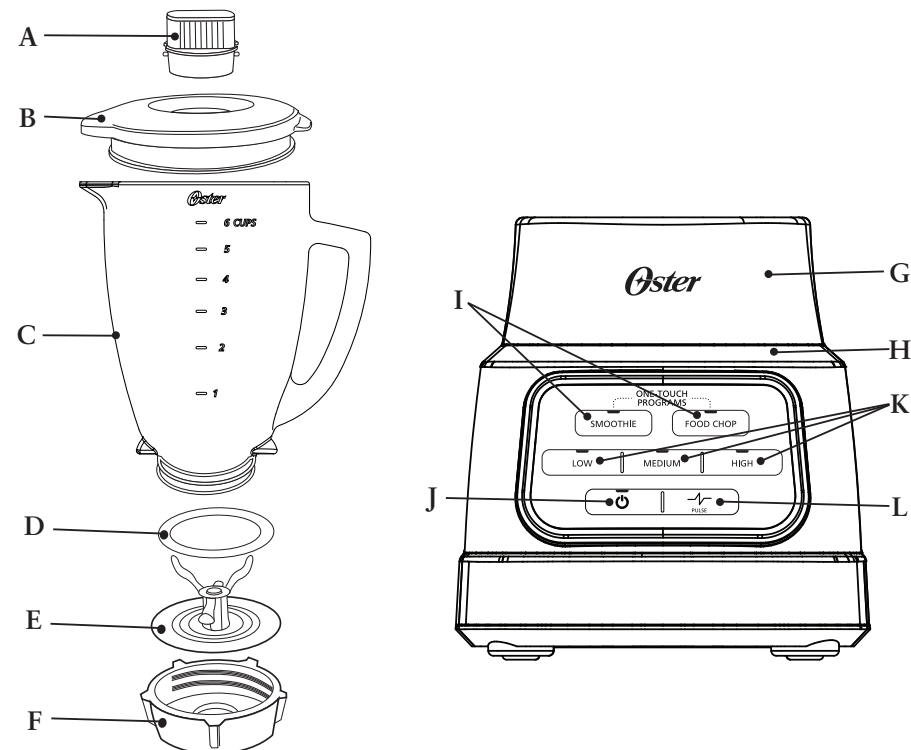

4

Using Your Blender

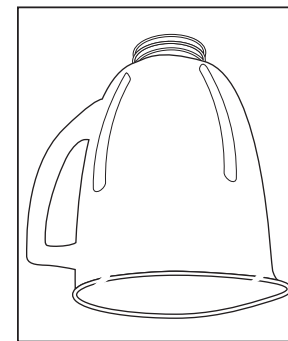

FIGURE 1

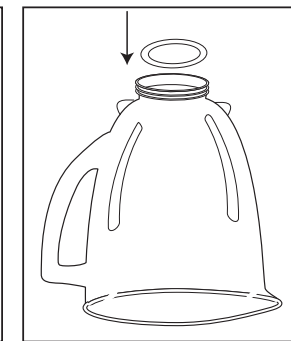

FIGURE 2

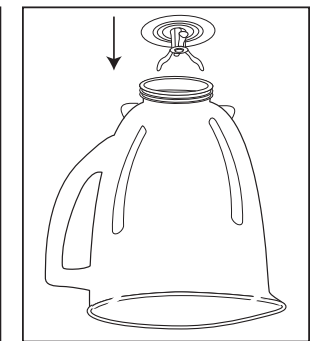

FIGURE 3

1. Clean Blender according to the instructions in the “Cleaning and Storing Your Blender” section. (Page 7)
2. Turn Blender Jar upside down so the small opening is at the top. (Figure 1)
3. Place Sealing Ring over Blender Jar opening. (Figure 2)
4. Place Blade System into Blender Jar. (Figure 3)
5. Place the Threaded Bottom Cap on Blender Jar and turn it clockwise to tighten. (Figure 4)
6. Place Blender Jar assembly onto Blender Base. (Figure 5)
7. **Line up tabs on Blender Base.** Make sure the tab on the jar (near the handle) is in front of the tab on the Blender Base. (Figure 6) Blender Jar should now be seated into position.
8. Place ingredients into Blender Jar.

NOTE: For best results, always add liquids first when blending, unless a recipe says otherwise.

9. Place Blender Lid with Filler Cap on Blender Jar.

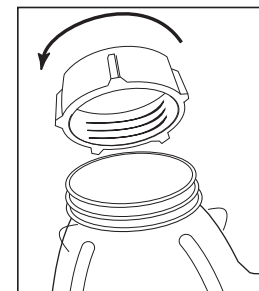

FIGURE 4

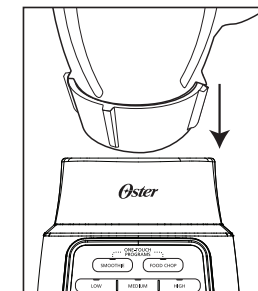

FIGURE 5

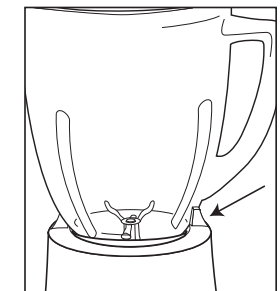

FIGURE 6

5

10. Plug the power cord into a 120 Volt AC electrical outlet.
11. Press the Power Button to turn the blender on. The power light will blink, indicating the product is active and ready to use.
12. Select the desired Pre-Programmed setting or Manual Setting. To change your selection, press Pulse followed by another Pre-Programmed Setting or Manual Setting.
13. Your Oster® Blender features 2 pre-programmed settings for superior results at the touch of a button. Simply select one of the Pre-Programmed Settings (Smoothie or Food Chop), and the blender will cycle through that program delivering professional results every time.
14. When using a Pre-Programmed Setting, the blender will automatically stop when the program is finished. The blinking green light indicates that the blender is ready for use.
15. Press the Power Button to turn the blender off.
16. To Pulse, push and hold down the Pulse Button for the desired length of time. Release and allow blade to stop. Repeat cycle as desired.

Blending Tips

- Put liquids in the Blender Jar first, unless a recipe says otherwise.
- Crushing ice: Crush 6 ice cubes or approximately 2 cups of ice. Cover ice with about 1 cup or 0.236 liters of water for best results.
- Do not remove the Blender Lid while in use. Remove Filler Cap to add smaller ingredients. (Figure 7)
- Cut all firm fruits and vegetables, cooked meats, fish and seafood into pieces no larger than 3/4 inch (1.9 cm) to 1 inch (2.5 cm). Cut all kinds of cheeses into pieces no larger than 3/4 inch (1.9 cm).
- This Blender will not mash potatoes, whip egg whites or substitute dairy toppings, mix stiff dough or grind raw meat.

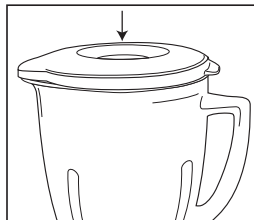

FIGURE 7

Hot Foods

- Open the Filler Cap to vent steam. Tilt Filler Cap away from you. Keep hands away from the cover opening to prevent possible burns.
- When working with hot liquids, remove Filler Cap and start blending at a low speed. Then move to a faster speed. DO NOT add liquid over the 4 cup (0.946 liter) level.

Cleaning Your Blender

WARNING: Unplug before cleaning. Do not immerse the blender base in water or any other liquid.

Use a damp, soft sponge with mild detergent to clean the outside of the Blender Base. All parts except for the Blender Base are dishwasher-safe. Place Sealing Ring in bottom basket of dishwasher. You can also wash the parts in warm, soapy water. Rinse well and dry.

EASY CLEAN FEATURE

Quickly and conveniently clean Blender Jar between uses without removing the blade from the jar.

- Pour 3 cups (0.709 liter) of warm water in the blender Jar.
- Add 1 – 2 drops of liquid dishwashing detergent.
- Select Low speed.
- Run blender for 20-30 seconds then press Power button.
- Empty jar of soapy water into sink and rinse the Blender Jar thoroughly with clean water.

NOTE:

Easy clean is not a substitute for regular cleaning described in the “Cleaning Your Blender” section above. It is especially important to disassemble and thoroughly clean your blender when processing milk, meats, seafood, and eggs.

NOTE:

This appliance has no user serviceable parts. Any servicing beyond that described in the Cleaning Section should be performed by an Authorized Service Representative only. See warranty available online.

Storing Your Blender

After cleaning and drying, reassemble Blade System to Blender Jar with Sealing Ring and Blender Jar Bottom Cap. Store Blender with cover ajar to prevent container odor.

Recipes

For fun and creative recipes for your new Oster® Blender visit us online at www.oster.com. Here you will find everything from the perfect Breakfast Smoothie to creamy Soups, Sauces and Frozen Drinks. For the perfect recipe for any occasion—turn on your creativity with Oster® Blenders!

GREEN SMOOTHIE RECIPE

Makes Cups	Green Grapes (Grams)	Baby Spinach (Grams)	Banana (2 inch chunks)	Pre-Cut Pineapple (Grams)	Ice Cubes Medium	Water (Cup)
2	87	14	2	38	2	0.5
3	130.5	21	3	57	3	0.5
4	174	28	4	76	4	0.5
5	217.5	35	5	95	5	0.5
6	261	42	6	114	6	0.5

Directions: Place ingredients in your Oster® Blender in the order listed. Select pre-programmed Smoothie setting.

STRAWBERRY SMOOTHIE

Makes Cups	White Grape Juice (Cup)	Strawberry Yogurt (oz.)	Medium Banana (2 inch chunks)	Ice Cubes Medium	Frozen Strawberries (g)	Ground Ginger (Tsp)
2	0.5	5	2	2	93	0.5
3	0.5	8	3	3	140	0.5
4	0.5	11	4	4	186	0.5
5	0.5	13	5	5	233	0.5
6	0.5	16	6	6	280	0.5

Directions: Place ingredients in your Oster® Blender in the order listed. Select pre-programmed Smoothie setting.

VANILLA MILKSHAKE

Makes Cups	Ice Cream Cups	Milk (Ounces)	Vanilla (Tsp)
2	2	6	1/8
3	3	9	1/4
4	4	12	1/4
5	5	15	3/8
6	6	18	3/8

Directions: Place ingredients in your Oster® Blender in the order listed. Select manual setting High for one minute. Add more milk if necessary.

MARGARITA

Makes Cups	Tequila (Ounces)	Margarita Mix (Ounces)	Ice Cups
2	2	6	1 1/2
3	3	9	2 1/2
4	4	12	3
5	5	15	4
6	5 1/2	18	5

Directions: Place ingredients in your Oster® Blender in the order listed. Select pre-programmed Smoothie setting.

FIERY RED SALSA

Makes Cups	Garlic cloves (large)	Whole tomatoes, drained (Ounces)	White onion, quartered (medium)	Fresh cilantro leaves (cup)	Jalapeños, stemmed and quartered (medium)	Natural cane sugar (Tsp)	Kosher salt	Lime juice (Tbsp)	Whole tomatoes, drained (Ounces)
3	2	14.5	1	1/2	1 to 4	1/2 to 1	To taste	1	14.5

Directions: Place ingredients in your Oster® Blender in the order listed. Select pre-programmed Food Chop setting.

3-Year Limited Warranty

Sunbeam Products, Inc. (collectively “Sunbeam”) warrants that for a period of three years from the date of purchase, this product will be free from defects in material and workmanship. Sunbeam, at its option, will repair or replace this product or any component of the product found to be defective during the warranty period. Replacement will be made with a new or remanufactured product or component. If the product is no longer available, replacement may be made with a similar product of equal or greater value. This is your exclusive warranty. Do NOT attempt to repair or adjust any electrical or mechanical functions on this product. Doing so will void this warranty.

This warranty is valid for the original retail purchaser from the date of initial retail purchase and is not transferable. Keep the original sales receipt. Proof of purchase is required to obtain warranty performance. Sunbeam dealers, service centers, or retail stores selling Sunbeam products do not have the right to alter, modify or any way change the terms and conditions of this warranty.

This warranty does not cover normal wear of parts or damage resulting from any of the following: negligent use or misuse of the product, use on improper voltage or current, use contrary to the operating instructions, disassembly, repair or alteration by anyone other than Sunbeam or an authorized Sunbeam service center. Further, the warranty does not cover: Acts of God, such as fire, flood, hurricanes and tornadoes.

What are the limits on Sunbeam’s Liability?

Sunbeam shall not be liable for any incidental or consequential damages caused by the breach of any express, implied or statutory warranty or condition.

Except to the extent prohibited by applicable law, any implied warranty or condition of merchantability or fitness for a particular purpose is limited in duration to the duration of the above warranty.

Sunbeam disclaims all other warranties, conditions or representations, express, implied, statutory or otherwise.

Sunbeam shall not be liable for any damages of any kind resulting from the purchase, use or misuse of, or inability to use the product including incidental, special, consequential or similar damages or loss of profits, or for any breach of contract, fundamental or otherwise, or for any claim brought against purchaser by any other party.

Some provinces, states or jurisdictions do not allow the exclusion or limitation of incidental or consequential damages or limitations on how long an implied warranty lasts, so the above limitations or exclusion may not apply to you.

This warranty gives you specific legal rights, and you may also have other rights that vary from province to province, state to state or jurisdiction to jurisdiction.

How To Obtain Warranty Service

In the U.S.A.

If you have any question regarding this warranty or would like to obtain warranty service, please call 1 800-334-0759 and a convenient service center address will be provided to you.

In the U.S.A., this warranty is offered by Sunbeam Products, Inc. located in Boca Raton, Florida 33431. If you have any other problem or claim in connection with this product, please write our Consumer Service Department.

PLEASE DO NOT RETURN THIS PRODUCT TO ANY OF THESE ADDRESSES OR TO THE PLACE OF PURCHASE.

For inquiries regarding recycling and proper disposal of this product, please contact your local waste management facility.

NOTES



Oster[®]



For product questions contact:
Oster[®] Consumer Service



USA: 1.800.334.0759

www.oster.com

©2020 Sunbeam Products Inc. All rights reserved. Product of Sunbeam Products Inc, 2381 NW.
Executive Center Dr. Boca Raton Florida 33431.